



TRIO
LIGHTING FOR YOU

2022



SAVE THE DATE



LICHTWOCHE
SAUERLAND

06. - 11.03.2022

INHALTSVERZEICHNIS

General Index · Index général · Algemene index · Índice general · Indice generale · Index general · Yleisindeksi · Ogólny indeks

Unternehmen · Company Entreprise · Onderneming · Empresa · Azienda · Compania · Yritys · Przedsiębiorstwo	4 - 5
Leuchtenfamilien & Kombinationen · Families & coordinates Familles & coordonnés · Families & combinaties · Familias & coordinados · Famiglie & coordinati · Famillii & Coordonate · Tuotepiheet & yhdistettävät tuotteet · Rodzinne orawy & kombinacje	30 - 171
Intelligente Lichtsteuerung · smart lighting control contrôle d'éclairage intelligent · slimme lichtregeling · control de iluminación inteligente · controllo intelligente dell'illuminazione · control inteligent al iluminatului · älykäs valaistuksen ohjaus · Inteligentne sterowanie światłem	172 - 195
Pendelleuchten & Kronen · Pendants & chandeliers Lustres & suspensions · Hanglampen & kroonluchters · Colgantes y Lámparas · Lampadari e sospensioni · Lustre si pendule · Riippu- & kruunu · Wiszące i żyrandole	196 - 247
Leuchten im Vintage Stil · Vintage style luminaires Luminaire style Vintage · Armaturen in Vintage stijl · Lámparas vintage · Apparecchi stile vintage · Corpuri de iluminat vintage · Vintage valaisimet · Lampy w stylu vintage	248 - 303
Wand- und Deckenleuchten · Wall & Ceiling lamps Applique & plafonniers · Wandlampen & plafonnières · Appliques y plafones · Applique e plafoniere · Plafoniere si aplice · Seinä- & katto · Sufitowe i ścienne	304 - 429
Steh- und Tischleuchten · Table- & floor lamps Lampes de table & lampadaires · Tafel- & vloerlampen · Sobremesas y lámparas de pie · Lampade da tavolo e piantane · Veioze si lampadare · Pöytä- & lattia · Stołowe i podłogowe	430 - 505
Spotserien · Spots Spotterie · Spots · Focos · Faretti · Spoturi · Spotit · Reflektorki	506 - 545
DUOline 2-Phasen-Schienensystem (230 V) · 2-phase track system (230 V) Système de voie à deux phases (230 V) · 2-fase-spoorsysteem (230 V) · Sistema de rieles en 2 fases (230 V) · Sistema a binario bifase (230 V) · Sistem de piste cu 2 faze (230 V) · 2-vaihekiskojärjestelmä (230 V) · 2-fazowy system prowadnic (230 V)	546 - 569
Einbauleuchten · Recessed spots Spots encastrés · Inbouwspots · Focos empotrables · Faretti incasso · Spoturi incastrate · Uputetut spotit · Oprawy wbudowane	570 - 587
Badezimmerleuchten · Bathroom lighting Éclairage salle de bains · Badkamer verlichting · Iluminación de cuarto de baño · Illuminazione per bagno · Iluminat baie · Kylpyhuone valaistus · Oświetlenie łazienkowe	588 - 621
Leuchtmittel · Light sources Ampoules · Lichtbronnen · Fuentes de luz · Lampadine · Becuri · Valonlähteet · Źródła światła	622 - 631
Spezifikationen · Specifications Spécifications · Specificaties · Especificaciones · Specifiche · Specificații · Tekniset tiedot · Specyfikacje	640 - 669
Kontakt · Contact Contact · Contact · Contactar · Contatto · Contact · Yhteydenotto · Kontakt	670 - 671

UNTERNEHMEN

Company · Entreprise · Onderneming · Empresa ·
Azienda · Compania · Yritys · Przedsiębiorstwo



30 JAHRE TRIO LEUCHTEN

Im April 1991 gegründet, blicken wir mit Stolz auf 30 Jahre Firmengeschichte zurück. Was damals mit nur wenigen Mitarbeitern begann, ist über die Jahre zu einem international erfolgreichen, mittelständischen Unternehmen herangewachsen. So beschäftigen wir innerhalb der TRIO Lighting Group heute rund 280 Mitarbeiter und sind ein kompetenter und ebenso zuverlässiger Partner für unsere Kunden.

Ein weiterer Grund zur Freude ist das 10-jährige Bestehen von TRIO International. Mit der Gründung 2011 wurde der Grundstein für die Internationalisierung gelegt und seitdem zielstrebig ausgebaut. Heute agiert TRIO International, darunter drei Joint Ventures, in über 40 Ländern und ist ein wichtiger Wachstumsfaktor und damit ein unverzichtbarer Bestandteil der TRIO Lighting Group.

Ein besonderer Meilenstein ist das im letzten Jahr fertiggestellte Firmengebäude im Gewerbegebiet Gut Nierhof. Auf einem Areal von rund 50.000 qm haben Verwaltung, Lager- und Logistik sowie ein über 1.000 qm großer Ausstellungsraum einen neuen Platz gefunden.

Wir sind stolz auf die Entwicklung der vergangenen Jahre. Die schnelle Anpassungsfähigkeit an Trends und technischen sowie wirtschaftlichen Wandel, eine konsequente und nachhaltige Kundenorientierung, aber auch unsere Motivation und Freude am Tun, haben uns zu dem gemacht, was wir heute sind. Wir freuen uns auf die nächsten 30 Jahre!

30 YEARS OF TRIO LEUCHTEN

Founded in April 1991, we can look back with pride on 30 years of company history. Initially starting out with only a few employees, it has grown over the years to become an internationally successful, medium-sized company. Today there are approximately 280 employees working for the TRIO Lighting Group and we remain both a competent and reliable partner for our customers.

The 10th anniversary of TRIO International is another reason to celebrate. With its foundation in 2011 the groundstone was laid for internationalisation and since then the company has consistently expanded. Today TRIO operates on an international level, including three Joint Ventures, in over 40 countries and is a significant growth factor and as such an indispensable component of the TRIO Lighting Group.

The company premises completed last year in the business park Gut Nierhof is a particularly special milestone. On an area of roughly 50,000 m² we have found a new location for administration, storage and logistics as well as a showroom boasting 1,000 m². We are proud of the development we have made in the past years. The rapid adaptability to trends and technical as well as economic change, consistent and sustained customer focus, as well as our motivation and pleasure in what we do have made us what we are today.

We look forward to the next 30 years!

30 ANS DE LUMINAIRES TRIO

Fondée en avril 1991, notre entreprise a 30 ans d'existence et nous en sommes fiers. Ce qui a commencé à l'époque avec une poignée de collaborateurs est devenu au fil des ans en une entreprise moyenne à succès international. Aujourd'hui, nous employons environ 280 personnes au sein de TRIO Lighting Group et sommes un partenaire à la fois compétent et fiable pour nos clients.

Une autre raison de célébrer est le 10^e anniversaire de TRIO International. La première pierre de l'internationalisation a été posée avec la fondation en 2011 et a depuis été développée de manière ciblée. Aujourd'hui, TRIO International, y compris trois joint-ventures, est présent dans plus de 40 pays et constitue un facteur de croissance important et donc une partie indispensable de TRIO Lighting Group.

Le nouveau siège de l'entreprise, dont la construction s'est achevée l'année dernière dans la zone d'activité commerciale de Gut Nierhof, constitue une

étape particulière. Sur une surface d'environ 50 000 m², l'administration, l'entrepôt et la logistique ainsi qu'un showroom de plus de 1000 m² ont trouvé un nouvel emplacement. Nous sommes fiers de l'évolution de ces dernières années. L'adaptabilité rapide aux tendances et aux changements techniques et économiques, une orientation client cohérente et durable ainsi que notre motivation et notre joie du travail bien fait ont résulté en ce que nous sommes aujourd'hui.

Nous nous réjouissons des 30 années à venir !

30 JAAR LAMPEN VAN TRIO

Ons bedrijf werd opgericht in april 1991 en daarom mogen we met trots terugkijken op dertig jaar geschiedenis. Wat toen begon met maar enkele medewerkers, is met de jaren uitgegroeid tot een internationaal succesvol middelgroot bedrijf. Zo stellen we binnen de TRIO Lighting Group vandaag rond 280 medewerkers te werk en zijn we een competente en betrouwbare partner voor onze klanten.

Nog een reden om te feesten is het tienjarig bestaan van TRIO International. Met de oprichting in 2011 werd de fundering voor de internationalisering gelegd en sindsdien doelbewust uitgebouwd. Vandaag is TRIO International, met daaronder drie joint ventures, actief in meer dan veertig landen en is een belangrijke groeifactor en zo een onontbeerlijk bestanddeel van de TRIO Lighting Group.

Een bijzondere mijlpaal is het vorig jaar afgewerkte firmagebouw in de handelszone Gut Nierhof. Op een terrein van rond 50.000 m² hebben de administratie, het magazijn en de logistieke afdeling alsook een meer dan 1000 m² grote showroom een nieuwe plek gekregen. We zijn trots op de ontwikkeling van de afgelopen jaren. Het snelle aanpassingsvermogen aan trends en technische alsook economische veranderingen, een consequente en duurzame klantgerichtheid, maar ook onze motivatie en enthousiasme hebben ons gemaakt tot wat we vandaag de dag zijn.

We kijken uit naar de volgende dertig jaar!

TRIO LEUCHTEN CUMPLE 30 AÑOS

Este mes recordamos con orgullo los treinta años de historia de nuestra empresa, fundada en abril de 1991. Lo que se inició con unos pocos empleados ha crecido a lo largo de los años hasta convertirse en una empresa mediana de gran éxito a nivel internacional. Actualmente, la empresa cuenta con una plantilla de aproximadamente 280 trabajadores dentro del grupo TRIO Lighting y somos un socio competente y fiable para nuestros clientes.

Otro motivo de regocijo es el décimo aniversario de TRIO International. Las bases para la internacionalización se establecieron con la fundación de la empresa en 2011 y desde entonces se han ampliado progresivamente. En la actualidad TRIO International, que incluye tres empresas conjuntas y opera en más de 40 países, es un importante factor de crecimiento y, por tanto, una parte indispensable del grupo TRIO Lighting.

Un hito especial lo constituye el edificio de la empresa en el polígono industrial Gut Nierhof, que se terminó de construir el año pasado. La administración, el almacén y el centro logístico, así como una sala de exposiciones de más de 1000 m², se han trasladado a nuevos locales situados en una superficie de unos 50 000 m². Estamos orgullosos del desarrollo que ha experimentado nuestra empresa durante los últimos años. Nuestra capacidad de adaptarnos rápidamente a las tendencias y a los cambios, tanto técnicos como económicos, y una orientación al cliente coherente y sostenible, así como nuestra motivación y la satisfacción que sentimos por nuestro trabajo, nos han convertido en lo que somos hoy.

Esperamos con optimismo lo que nos depararán los próximos 30 años.

30 ANNI DI SPLENDORE TRIO

Fondata nell'aprile 1991, possiamo guardare con orgoglio a 30 anni di storia aziendale. Quella che iniziò con pochi dipendenti è cresciuta nel corso degli anni fino a diventare un'azienda di medie dimensioni e di successo internazionale. Di conseguenza, oggi nel gruppo TRIO Lighting impieghiamo circa 280 persone e siamo un partner competente e altrettanto affidabile per i nostri clienti.

Un altro motivo per festeggiare è il 10° anniversario di TRIO International. La prima pietra per l'internazionalizzazione è stata posta con la costituzione dell'azienda nel 2011 e da allora è stata ampliata in modo mirato. Oggi TRIO International, comprese tre joint venture, opera in più di 40 paesi ed è un importante fattore di crescita e quindi una parte indispensabile del TRIO Lighting Group.

Una pietra miliare speciale è rappresentata dall'edificio aziendale nella zona industriale di Gut Nierhof, che è stato completato l'anno scorso. L'amministrazione, il magazzino e la logistica, nonché uno showroom di oltre 1.000 mq hanno trovato un nuovo posto su un'area di circa 50.000 mq. Siamo orgogliosi dello sviluppo degli ultimi anni. La capacità di adattarsi rapidamente alle tendenze e ai cambiamenti tecnici ed economici, un orientamento al cliente coerente e duraturo, ma anche la nostra motivazione e la gioia di fare hanno fatto di noi quello che siamo oggi.

Non vediamo l'ora di festeggiare i prossimi 30 anni!



30 DE ANI DE TRIO LEUCHTEN

Fiind înființată în aprilie 1991, avem posibilitatea de a privi cu mândrie asupra a 30 de ani de istorie a companiei. Ce a început cu o mână de angajați, a crescut pe parcursul anilor într-o companie de mărime medie, cu succes pe plan internațional. Astfel, TRIO Lighting Group are la momentul actual un număr de aproximativ 280 de angajați, fiind un partener competent și de încredere pentru clienții noștri.

Un alt motiv de bucurie îl reprezintă aniversarea de 10 ani de la înființarea TRIO International. Odată cu fondarea în 2011, s-a pus temelia pentru procesul de internaționalizare, care este extins permanent din acel moment. La momentul actual, TRIO International, prezintă și în trei Joint Ventures, este reprezentată în 40 de țări, reprezentând un factor de dezvoltare esențial și astfel o componentă cheie pentru TRIO Lighting Group.

O etapă importantă este reprezentată de finalizarea clădirii care găzduiește sediul companiei, în zona industrială Gut Nierhof. Pe o suprafață de aproximativ 50.000 mp se regăsesc clădirile administrative, depozitele, logistica, precum și un spațiu expozițional de peste 1000 mp. Suntem mândri de dezvoltarea, care a avut loc în ultimii ani. Capacitatea de a adapta rapidă la tenduri și la evoluția tehnică și economică, orientarea consecventă și sustenabilă către clienți, dar și motivația noastră și bucuria de a realiza, ne-au făcut ceea ce suntem la ora actuală.

Ne bucurăm de perspectiva următorilor 30 de ani!

30 VUOTTA TRIO-VALAISIMIA

Vuonna 1991 perustettu yrityksemme katsoo ylpeänä 30 vuoden historiaansa. Mikä alkoi silloin vain muutaman työntekijän voimin, on vuosien mittaan kasvanut kansainvälisesti menestyväksi, keskiuureksi yritykseksi. Työllistämme tänään TRIO Lighting Groupissa noin 280 henkilöä, ja olemme pätevä ja luotettava kumppani asiakkaillemme.

Toinen syy iloon on TRIO Internationalin 10-vuotisjuhla. Kansainvälistymisemme peruskivi laskettiin, kun se perustettiin vuonna 2011, ja olemme laajentaneet sitä systemaattisesti siitä lähtien. Tänään TRIO International, johon kuuluu kolme yhteisyritystä, toimii yli 40 maassa ja on tärkeä kasvutekijä ja siten olennainen osa TRIO Lighting -konsernia.

Viime vuonna valmistunut yritysrakennus Gut Nierhofin teollisuusalueella on meille erityinen virstanpylväs. Noin 50 000 neliömetrin alueella hallinto, varasto ja logistiikka sekä yli 1 000 neliömetrin esittelytila ovat löytäneet uuden kodin. Olemme ylpeitä muutaman viime vuoden kehityksestä. Kyky sopeutua nopeasti trendien vaihteluun sekä teknisiin ja taloudellisiin muutoksiin, johdonmukainen ja kestävä asiakaslähtöisyys, sekä motivaatiomme ja ilomme tehdä asioita, ovat tehneet meistä sen, mitä nyt olemme.

Odotamme innolla seuraavia kolmeakymmentä vuotta!

30 LAT TRIO LEUCHTEN

Nasza firma została założona w kwietniu 1991 roku, a dziś możemy z dumą spoglądać wstecz na jej 30-letnią historię. Początkowo zatrudniała jedynie kilka osób, jednak z biegiem lat rozwinęła się i stała się odnoszącą międzynarodowe sukcesy firmą średniej wielkości. Dziś w TRIO Lighting Group pracuje około 280 osób i pozostajemy zarówno kompetentnym, jak i niezawodnym partnerem dla naszych klientów.

Dziesięciolecie istnienia TRIO International to kolejny powód do świętowania. Wraz z jej powstaniem w 2011 roku firma zaczęła rozwijać się na skalę międzynarodową. Dziś TRIO International posiada swoje oddziały za granicą w ponad 40 krajach, w tym m.in. trzy spółki typu joint venture i w znaczącym stopniu przyczynia się do rozwoju całej Grupy TRIO Lighting.

Ważnym osiągnięciem jest ukończona w ubiegłym roku siedziba firmy w parku biznesowym Gut Nierhof. Na powierzchni około 50 000 m² znaleźliśmy nową lokalizację dla naszych działów administracji, magazynowania i logistyki oraz salonu wystawowego o powierzchni 1000 m². Jesteśmy dumni z rozwoju, jaki dokonał się w ostatnich latach. Szybka adaptacja do trendów oraz zmian technicznych i ekonomicznych, konsekwentne i trwałe zorientowanie na klienta, a także nasza motywacja i przyjemność z wykonywanej pracy, doprowadziły nas do tego sukcesu.

Z optymizmem spoglądamy na kolejne 30 lat naszej działalności!

SERIENÜBERSICHT

Family overview · Aperçu par famille · Overzicht per familie · Vista general por familia ·
Panoramica per famiglia · Presentare pe familii de produse · Perheen yleiskuvaus · Przegląd rodziny

AARON	180	BERGAMO	470	CITIZEN	182	DONNA	496	GONZALO	372
ABERDEEN	393	BERLIN	497	CLAAS	443	DOWNEY	311	GOTHAM	294
ADRIAN	416	BISCUIT	367	CLAPTON	512	DRAGON	325	GRANADA	332
ADRIANA	192	BODRUM	339	CLARIMO	594	DURBAN	202	GRANDE	482
ADRIANO	395	BOLDER	406	CLARK	441	ECCO	428	GRIFFIN	186
AGENTO	86	BOLSA	592	CLEO	376	EDGE	50	HARRIET	342
AGRA	271	BOOLAN	222	CLERMONT	218	EDWARD	477	HARRIS	258
AICK	207	BOSTON	237	COLIN	243	ELEMENT	381	HEDDA	273
ALEGRO	210	BOWIE	534	COLINA	412	ELMAU	282	HENK	498
ALICIA	118	BRAD	250	COLUMBIA	368	ELSA	227	HENLEY	260
ALINO	427	BRADLEY	270	COMTESS	411	EMBASSY	405	HOLLY	236
AMSTERDAM	484	BULTO	416	CONCHA	388	EMERALD	496	HOSTEL	108
ANDREUS	106	BUSA	419	CONCRETE	532	FABIO	600	HOSTEL	568
ANGELO	612	CAFU	56	CONDOR	360	FACELLA	402	HOSTEL	568
ANTIBES	564	CALAIS	241	CONDUS	621	FARO	125	HOTEL	94
APART	616	CALCIO	474	CONNOR	148	FERNANDO	364	HOUSTON	545
ARAGON	426	CALVARO	212	CONO	402	FIGO	192	HYDRA	314
ARANGO	464	CAMDEN	80	COOKIE	366	FILIGRAN	479	IBIS	102
ARINO	254	CAMILLA	619	CORBIE	347	FILO	140	ICARO	478
ARIZONA	464	CAMILLUS	566	CORD	278	FISHERMAN	303	INDIRA	316
ARVIN	319	CAMPO	403	CORE	578	FLETCHER	158	IRVINE	309
ARY	500	CANDELA	225	CORTEZ	230	FLEXO	492	IVAR	288
ASCARI	590	CANNES II	451	COVENTRY	214	FLORESTAN	436	JACOB	301
AURA	580	CAPITAL	236	CRISTO	500	FORESTER	285	JAMIRO	152
AURORA	376	CARBONADO	415	CROSS	156	FRANCIS	38	JANKO	272
AVA	483	CARICO	538	CUADRO	398	FRANKLIN	32	JASMIN	302
AVUS	72	CARLO	391	CUBA	510	FRED	423	JASPER	160
BAJO	246	CARRERA	40	CUBE	394	FREDDY	542	JIMMY	568
BALDO	407	CAVALLO	208	CURL	204	FRODENO	615	JIVE	44
BALINI	116	CENTO	375	CURTIS	399	FYNN	499	JOHANN	298
BALOUBET	467	CESAR	373	CURVA	417	GALE	327	JOOST	498
BANGKOK	432	CHARIVARI	46	DAVI	501	GANADO	321	JORDAN	383
BARON	146	CHARLESTON	307	DEACON	76	GARDA	104	JUDITH	276
BARONESS	144	CHARLY	190	DELHI	262	GAYA	266	JURA	584
BARRIE	461	CHICO	419	DIALLO	150	GEMMA	410	KAGAWA	345
BASIC	520	CHIRON	232	DIAMO	193	GENT	453	KAZAN	472
BELA	154	CHIROS	377	DIEGO	245	GIADA	611	KENAI	586
BELFAST	58	CHRIS	466	DISCALGO	162	GIANNI	591	KHAN	268
BELL	256	CHRISTOBAL	413	DIVO	420	GIRONA	350	KIMI	489
BELLARI	78	CINZIA	593	DOLOMITE	582	GOA	529	KOLIAN	602

KORBA	280	MELVIN	387	PEACOCK	336	RUSTICA	166	TRACY	440
LACAL	209	MICHAEL	536	PEREZ	442	SALERNO	64	TRADITIO	170
LACAN	503	MIDAS	240	PHOENIX	370	SALINAS	48	TRAJAN	199
LACAPO	385	MIGUEL	386	PIERA	598	SALSA	331	TRINITY	392
LAGOS	516	MIKO	357	PIET	505	SAMURAI	362	TRUMPET	544
LANA	418	MINSK	224	PILATUS	518	SANDRINA	132	TUBULAR	216
LANCE	456	MONTI	503	PILLAR	459	SANNA	300	TUCSON	52
LAON	422	MONZA	468	PIRIN	582	SANTO II	465	TURNER	324
LARA	296	MOONY	404	PLANT	284	SAPPORO	356	UMBERTO	617
LEON	522	MORRISON	201	PLATON	392	SEDONA	334	VALENTE	128
LEVISTO	540	MORTEN	502	POLLY	488	SEIKO	363	VAPORE	122
LIÈGE	454	MOSAIQUE	410	POLO	488	SETA	502	VARIO	486
LIGARA	422	NADAL	485	PONTE	438	SHANGHAI	434	VENTURA	494
LILLY	409	NAGANO	359	PRETO	490	SHARK	518	VERONA	471
LINE	406	NALIDA	190	PRIMO	418	SHOGUN	362	VERUS	349
LINO	608	NANDOR	450	PRONTO	492	SIGNA	130	VIEW	606
LINZ	452	NAPOLI	164	PURE	114	SIMEO	425	VIOLA	244
LOGAN	43	NARCOS	514	QUEBEC	463	SOLA	437	VISTA	188
LOOP	74	NECTOR	194	QUINTA	400	SORRENTO	54	WAILER	110
LORELEY	231	NIKOSIA	136	RADIATOR	560	SPIRELLI	134	WALES	393
LORENZO	610	NO.5	297	RADO	487	SPLIT	458	WINONA	323
LOTUS	358	NORA	414	RAIKO	363	STAKKATO	213	XAVI	620
LOUIS	384	NORIAKI	360	RAMIRO	239	STAMINA	242	YARA	34
LUCERNA	228	OAKLAND	36	RAMON	429	SUBARA	344	YAVA	329
LUGANO	88	OKINAWA	352	RAVEN	346	SWEETY	138	ZAGROS	574
LUIGI	378	OLYMPUS	75	RAY	595	SYDNEY	66	ZANDOR	142
LUIS	494	ONTARIO	126	REPOSA	401	TAJO	493	ZAZOU	408
LUNAR	361	ONYX	234	RILA	576	TANDORI	448	ZENIA	618
LUPO	491	ORCHESTRA	163	ROBIN	112	TANJA	300	ZEUS	374
LYON	84	OSAKA	354	ROCCO	596	TAURUS	508	ZITA	397
MACAU	206	OSCAR	184	RODERIC	486	TEXEL	455	ZORRO	396
MADRAS	286	OTTAWA	238	RODRIGO	261	THEATRO	607	ZUCCA	246
MARIO	378	OXFORD	313	ROMA	408	THIAGO	183		
MARIO	378	PAGO	530	ROMINO II	238	TILL	501		
MARLEY	524	PAMIR	572	RONDO	68	TIRIAC	62		
MARRIOT	379	PANTILON	191	ROPE	277	TITUS	340		
MARTA	420	PAOLO	614	ROTIN	276	TOKYO	358		
MATS	504	PAPER	247	ROUBAIX	560	TOMMY	569		
MATTIMO	604	PARIS II	446	RUBY	338	TOSH	290		
MELBY	189	PAROS	563	RUNA	274	TOULON	421		

PENDELLEUCHTEN & KRONEN

Pendants & chandeliers · Lustres & suspensions · Hanglampen & kroonluchters · Colgantes y Lámparas · Lampadari e sospensioni · Lustre si pendule · Riippu- & kruunu · Wiszące i żyrandole

8

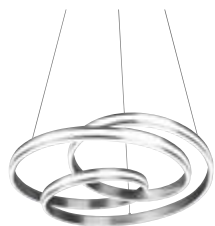

YARA 34



MACAU 206



DURBAN 202



AARON 181

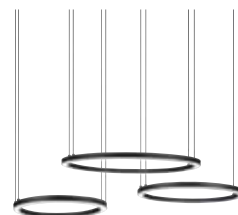

MORRISON 201



OAKLAND 37



FRANKLIN 32

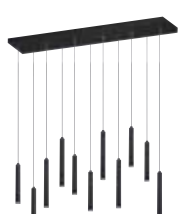

TUBULAR 216



CLERMONT 218



MARLEY 220

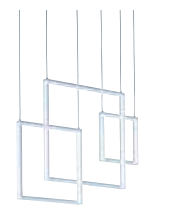

TUCSON 52

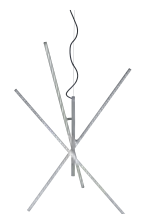

TIRIAC 62



TRAJAN 198



SALINAS 48



EDGE 50

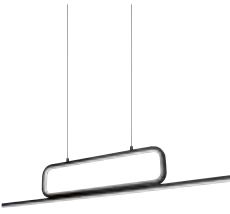

AICK 207



BELFAST 59



SALERNO 64

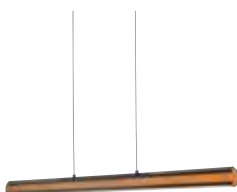

DEACON 77

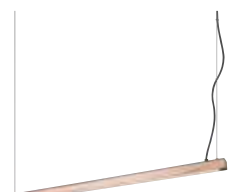

BELLARI 78



ALEGRO 210

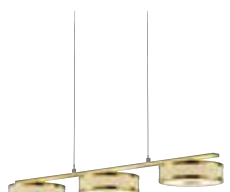

AGENTO 86



CURL 204



CHARIVARI 46



LACAL 209



CAVALLO 208



CALVARO 212



STAKKATO 213



CARICO 539



FREDDY 543



FILO 140



ZANDOR 143



BARON 146



BARONESS 144



BOSTON 237



JASPER 161



FRANCIS 38



CARRERA 40



LOGAN 43

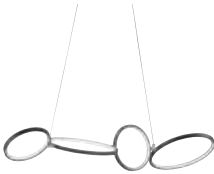

RONDO 70

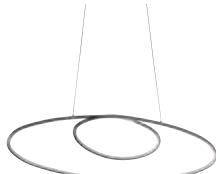

AVUS 73



CAFU 57



COVENTRY 214



RAMIRO 239



SYDNEY 67



OLYMPUS 75

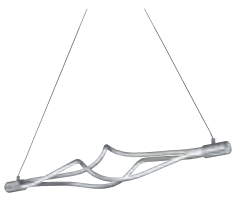

LOOP 74



LEVISTO 540



STAMINA 242

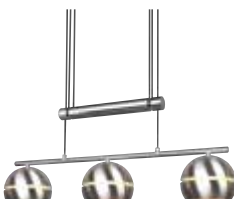

FLETCHER 158



CAPITAL 236



HOLLY 236



PENDELLEUCHTEN & KRONEN

Pendants & chandeliers · Lustres & suspensions · Hanglampen & kroonluchters · Colgantes y Lámparas · Lampadari e sospensioni · Lustre si pendule · Riippu- & kruunu · Wiszące i żyrandole



BRAD 250

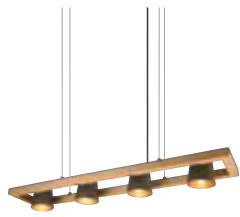

BELL 257



AGRA 271



KHAN 269



DEHLI 262



GAYA 266



HEDDA 273



RUNA 274



TOSH 290



HARRIS 258



HENLEY 260



IVAR 288

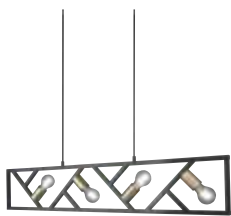

BELA 254



CROSS 156

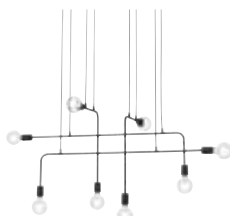

CONNOR 148



CORD 278



JAMIRO 152



ONYX 234



RUSTICA 166



ELSA 227



NAPOLI 164



TRADITIO 170



BOOLAN 222



CANDELA 225



CAMDEN 80



HOTEL 95



WAILER 111



GARDA 105



LUGANO 88



CORTEZ 230



VAPORE 122



VALENTE 129



ALICIA 118



MIDAS 240



BALINI 116



ROBIN 112



SIGNA 131



SIRELLI 135



SANDRINA 133



NIKOSIA 137



VIOLA 244



COLIN 243



MADRAS 287



PLANT 284



FORESTER 285



ELMAU 282



KORBA 280



JACOB 301



TANJA 300



SANNA 300



FISHERMAN 303



JASMIN 302



GOTHAM 294



ORCHESTRA 163



DISCALGO 162



ROMINO II 238



OTTAWA 238



CHIRON 232

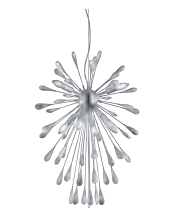

MINSK 224



LUCERNA 228



IBIS 102



LORELEY 231



HOTEL 97



HOSTEL 109



ANDREUS 106



CALAIS 241



FARO 125



ONTARIO 127



ONTARIO 126



PURE 115



DIEGO 245



SWEETY 138



ZUCCA 246



BAJO 246



PAPER 247

DECKENLEUCHTEN

Ceiling lamps · Plafonniers · Plafonnières · Plafones ·
Plafoniere · Plafoniere · Kattvalaisimet · Plafony



YARA 34



FRANCIS 38



CARRERA 40



GALE 327



AARON 180



WINONA 323



JIVE 44



SALSA 331



YAVA 329



RONDO 70



AVUS 72



CITIZEN 182



CHARLESTON 307

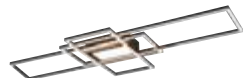

IRVINE 309



SALINAS 48



GANADO 321



TUCSON 308



SEDONA 335

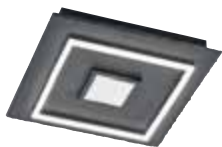

CORBIE 347

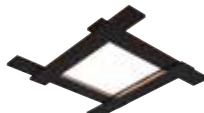

BELFAST 58



OXFORD 313



TIRIAC 62



TURNER 324



DRAGON 325

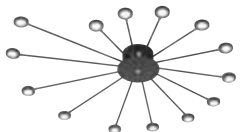

PEACOCK 337



BODRUM 339



SYDNEY 66



HARRIET 342

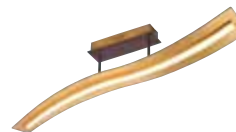

SALERNO 64



CHARIVARI 46



GIRONA 351



BARON 146



ZANDOR 142



BARONESS 144



COOKIE 366



BISCUIT 367



VERUS 349



OKINAWA 353



TOKYO 358



MIKO 357



OSAKA 355



NORIAKI 360



SEDONA 334



OAKLAND 36

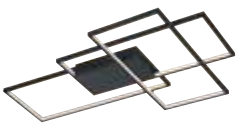

THIAGO 183

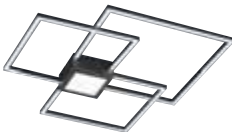

HYDRA 314



DOWNEY 311



LOGAN 42

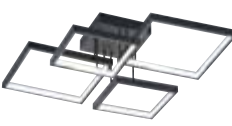

SORRENTO 54

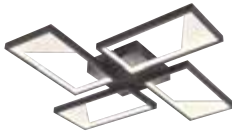

CAFU 56



MELBY 189



ARVIN 319



INDIRA 316



GRANADA 333



DEACON 76



BELLARI 79



FERNANDO 364



OSCAR 184



SUBARA 344



KAGAWA 345



RUBY 338



DECKENLEUCHTEN

Ceiling lamps · Plafonniers · Plafonnières · Plafones ·
Plafoniere · Plafoniere · Kattvalaisimet · Plafony

14



NALIDA 190



LOTUS 358



SEIKO 363



RAIKO 363



CESAR 373



CONDOR 360



TITUS 340



COLUMBIA 369



GRIFFIN 186



PHOENIX 370



CENTO 375



ZEUS 374



CAMDEN 80



LUGANO 91



HOTEL 94



HOTEL 96



LUGANO 93



DIAMO 193



ALICIA 120



VALENTE 128



VAPORE 122



FARO 124

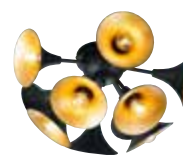

OCHESTRA 163



DISCALGO 162



BRAD 250



BELL 256



KHAN 268



HEDDA 273



KORBA 280



ELMAU 282



CHIROS 377



COMTESS 411



NIKOSIA 136



MOSAIQUE 410



CHRISTOBAL 413



GEMMA 410



BUSA 419



PRIMO 418



CHICO 419



CARBONADO 415



NORA 414



LANA 418



LUNAR 361

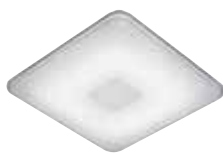

SAMURAI 364



SHOGUN 364



CHARLY 190



SAPPORO 356



GONZALO 372



EMBASSY 405



MOONY 404



GARDA 104



HOSTEL 108



IBIS 102

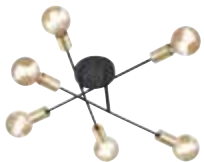

CROSS 156



DIALLO 150



JOHANN 298



REPOSA 401



NAPOLI 164



TRADITIO 170



QUINTA 400



RUSTICA 166



ADRIAN 416



BULTO 416



SANDRINA 132



SPIRELLI 134

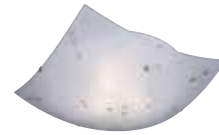

COLINA 412



SIGNA 130



SWEETY 138



LILLY 409



CUBE 394



CARICO 539



CLAPTON 513



CURVA 417

WANDLEUCHTEN

Wall lamps · Appliques · Wandlampen · Apliques ·
Appliques · Lămpi de perete · Seinävalaisimet · Science

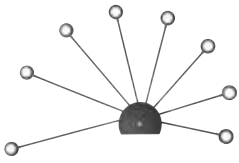

PEACOCK 336



BELFAST 58



ADRIANA 192



MIGUEL 386



ADRIANO 395



CARLO 390



MELVIN 387



CONCHA 388



FIGO 192



RAVEN 346



MARLEY 527



ZITA 397



SUBARA 344



TRINITY 392



PLATON 392



CUBE 394



ROMA 408



ZAZOU 408



MARRIOT 379

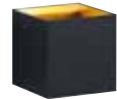

LOUIS 384



ANDREUS 107

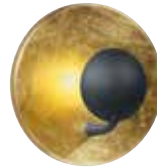

AURORA 376

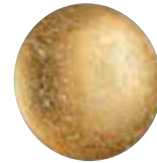

CHIROS 377



CLEO 376

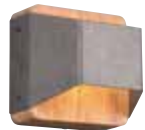

ARINO 254



BRADLEY 270



BRAD 250



KHAN 268



GAYA 266



TRADITIO 171



LUGANO 88



HOTEL 100



BALDO 407



BOLDER 406



LINE 406



DIALLO 150



SWEETY 138



COLINA 412



SANDRINA 132



SPIRELLI 135



NIKOSIA 136



CARBONADO 415



ABERDEEN 393



WALES 393



LACAPO 385



VISTA 188



ZANDOR 142



ZORRO 396



MARIO 378



LUIGI 378



JORDAN 383



ELEMENT 381



KAZAN 472



EDWARD 477



LYON 84



PURE 114



CURTIS 399



CUADRO 398



LUCERNA 228



GOTHAM 294



CAMPO 403



FACELLA 402



CONO 402



SIGNA 130



CHRISTOBAL 413



DIVO 420



MARTA 420



TOULON 421

SPOTSERIEN

Spots · Spotterie · Spots · Focos · Faretti · Spoturi · Spotit · Reflektorki

18



CUBA 510



NARCOS 515



CLAPTON 513

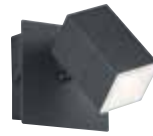

LAGOS 516



TAURUS 508



LEON 522



BOWIE 534



MICHAEL 536



CONCRETE 532



WAILER 110



LEVISTO 540



FREDDY 542



BELL 256



MARLEY 252



MADRAS 286



TOSH 292



DEHLI 264



PILATUS 518



SHARK 518



BALOUBET 520



BASIC 520



LEVISTO 423



LAON 422

2-PHASEN-SCHIENENSYSTEM



2-phase track system · Système de voie à deux phases · 2-fase-spoorsysteem · Sistema de rieles en 2 fases · Sistema a binario bifase · Sistem de piste cu 2 faze · 2-vaihekiskojärjestelmä · 2-fazowy system prowadnic



RADIATOR 560



ROUBAIX 560



LEON 560



MARLEY 562



ANTIBES 564



TOMMY 569



CAMILLUS 566



PANEL 566

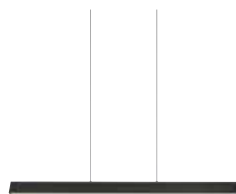

PAROS 563



ONTARIO 564



JIMMY 568



HOSTEL 568



GOA 529



PAGO 530



MARLEY 524



CARICO 538



TRUMPET 544



HOUSTON 545



FRED 423



LIGARA 422



DIALLO 564



TOSH 564



HOTEL 568



HOTEL 568



HOSTEL 568



TISCHLEUCHTEN

Table lamps · Lampes de table · Tafellampen · Sobremesas ·
Lampa da tavolo · Veioze · Pöytävalaisimet · Lampy stołowe



TANDORI 448



AGENTO 87



LYON 84



PARIS II 446



NANDOR 450



HOSTEL 108



CHARIVARI 47



FRANKLIN 53



BARONESS 144



RONDO 70



CAFU 56



SORRENTO 54



LOOP 74



SYDNEY 66



VAPORE 122



ALICIA 118



FARO 124



ROBIN 113



BERLIN 497



PURE 114



JOOST 498



HENK 498



DONNA 496



VENTURA 494



EMERALD 496



LUIS 494



MORTEN 502



CRISTO 500



MONTI 503



FYNN 499



ARY 500



TILL 501



DAVI 501



SETA 502



LACAN 503



JAMIRO 153



TISCHLEUCHTEN

Table lamps · Lampes de table · Tafellampen · Sobremesas ·
Lampa da tavolo · Veioze · Pöytävalaisimet · Lampy stołowe

22



AVA 483



NADAL 485



RADO 487



RODERIC 486



AMSTERDAM 484



GRANDE 482



MONZA 468



POLO 488



CALCIO 474



PRETO 490



NARCOS 515



CURTIS 495



POLLY 488



LUPO 491



BALOUBET 467



MARLEY 480



JASPER 160



FREDDY 542



KIMI 489



TOSH 293



TAJO 493



PRONTO 492



FLEXO 492



VARIO 486



BERGAMO 470



FLETCHER 158



DIALLO 151



JANKO 272



STEHLEUCHTEN

Floor lamps · Lampadaires · Vloerlampen · Lámparas de pie · Piantane · Lampadare · Lattiavalaisimet · Lampy podłogowe



CAMDEN 81

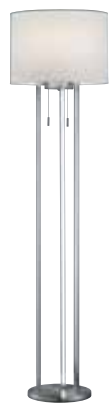

TANDORI 448



CANNES II 451



PARIS II 446



LYON 85



NANDOR 450



CONNOR 148



DIALLO 151



BELA 154



CROSS 156



TEXEL 455



GENT 453



VAPORE 123

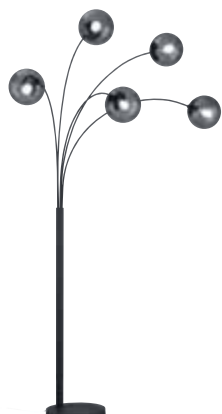

BALINI 117



ALICIA 118



LANCE 456



FILO 140



PURE 115



KHAN 269



BELL 256



HARRIS 258



RODRIGO 261



GAYA 266



TOSH 290



CLAAS 443



HOTEL 99

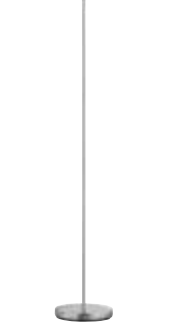

HOTEL 98



CLARK 441



PONTE 438



TRACY 440



HOSTEL 109



ANDREUS 106



PEREZ 442



LINZ 452



LIÈGE 454



IVAR 288



DEHLI 264



NO. 5 297



JANKO 272



KORBA 281



RUNA 274

STEHLEUCHTEN

Floor lamps · Lampadaires · Vloerlampen · Lámparas de pie ·
Piantane · Lampadare · Lattiavalaisimet · Lampy podłogowe

26

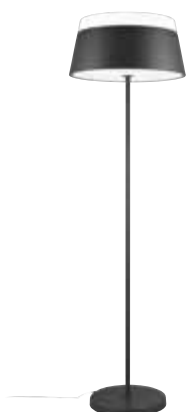

BARONESS 145



YARA 35



JIVE 45



RONDO 71



AVUS 72



CAFU 57



CHARIVARI 47



EDGE 50



BELLARI 78



PILLAR 459



PANTILON 191



OAKLAND 36



BARRIE 461



QUEBEC 463



SPLIT 458



SANTO II 465



ARIZONA 464



MONZA 468



KAZAN 472

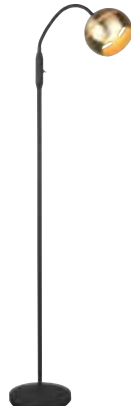

FLETCHER 158



MARLEY 480



JASPER 160



ICARO 478



SORRENTO 54



SALERNO 64



TUCSON 52



LOOP 74



SYDNEY 66



OLYMPUS 75



SOLA 437



CHRIS 466



FLORESTAN 436



BANGKOK 432

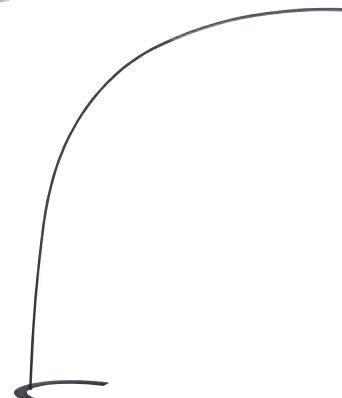

SHANGHAI 434



FILIGRAN 479



CHRIS 466



ARANGO 464



RUSTICA 169



CALCIO 474



BERGAMO 470



VERONA 471



EDWARD 477



NARCOS 476



CONCRETE 533



LAGOS 516



BALOUBET 467

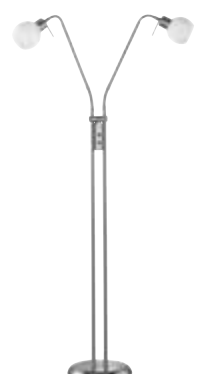

FREDDY 543

BADEZIMMERLEUCHTEN H_2O

Bathroom lighting · Éclairage salle de bains · Badkamer verlichting · Iluminación de cuarto de baño · Illuminazione per bagno · Iluminat baie · Kylpyhuone valaistus · Oświetlenie łazienkowe

28



ASCARI 590



CINZIA 593



CAMILLA 619



APART 616



CLARIMO 594



CONDUS 621



BOLSA 592



ANGELO 612



RAY 595



BOLSA 592



VIEW 606



GIANNI 591



PIERA 598



ROCCO 596



FABIO 600



MATTIMO 604



KOLIAN 602



XAVI 620

EIN- UND UNTERBAULEUCHTEN

Recessed and cabinet lightings · Eclairages encastrés et éclairages sous armoire · Inbouwverlichtingen en verlichtingen onder de kastjes · Luces empotrables y luces para la parte inferior del armario · Lampade da incasso e lampade sottopensili · Lumini încastrate și lumini sub dulap · Uputettavat valaisimet ja kaapinalusvalaisimet · Oprawy wpuszczane oraz oprawy podszafkowe



AURA 580



CORE 578



ZAGROS 574



ZAGROS 574



PAMIR 572



PAMIR 572

H_2O



JURA 584



JURA 584



DOLOMITE 582



PIRIN 582



ZENIA 618



SIMEO 425



ARAGON 426



ALINO 427



RAMON 429



ECCO 428



UMBERTO 617



FRODENO 615



PAOLO 614



THEATRO 607



LINO 608



LORENZO 610



GIADA 611



RILA 576



RILA 576



KENAI 586







30 - 171

Leuchtenfamilien & Kombinationen

Families & coordinates

Familles & coordonnés

Families & combinaties

Familias & coordinados

Famiglie & coordinati

Famillii & Coordonate

Tuoteperheet & yhdistettävät tuotteet

Rodzinne orawy & kombinacje

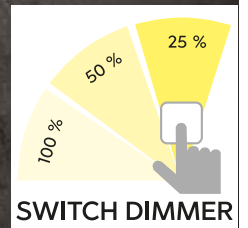

Pendelleuchte · Pendant
 ↑ 85 - 180 cm, Ø 14 cm
 incl. SMD-LED, 9 W
 1.050 lm, 3.000 K



326510107
 326510108
 326510142



Pendelleuchte · Pendant
 ↑ 85 - 150 cm, ↔ 55 x 14 cm
 incl. 2 x SMD-LED, 9 W
 2 x 1.050 lm, 3.000 K



326510207
 326510208
 326510242



Pendelleuchte · Pendant
 ↑ 85 - 150 cm, ↔ 85 x 14 cm
 incl. 3 x SMD-LED, 9 W
 3 x 1.050 lm, 3.000 K



326510307
 326510308
 326510342



Tischleuchte · Table lamp
 ↑ 25 cm, Ø 14 cm
 incl. SMD-LED, 6 W
 700 lm, 3.000 K



526510107
 526510108
 526510142



FRANKLIN

Metall · metal ·
metale · metaal · metal · metallo · metal · metalli · metal

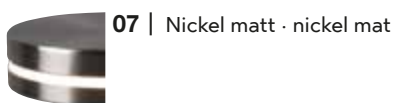

07 | Nickel matt · nickel mat

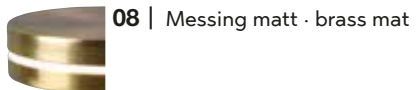

08 | Messing matt · brass mat

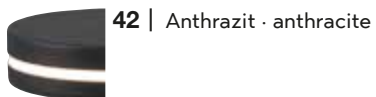

42 | Anthrazit · anthracite



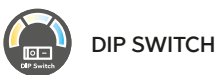
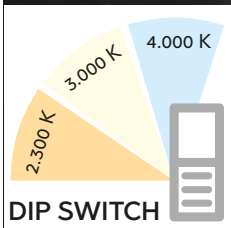

Lichtfarben direkt an der Leuchte einstellbar · Colours directly adjustable at the lamp · Les couleurs de la lumière peuvent être réglées directement sur le luminaire · Lichtkleuren direct instelbaar op de lamp · Tonalidades de luz ajustables directamente en la lámpara · Colori della luce regolabili direttamente sulla lampada · Culori ale luminii reglabile direct de la bec · Valon väri asetettävissa suoraan valaisimesta · Barwy światła można ustawić bezpośrednio na oprawie



Deckenleuchte · Ceiling lamp
 Ø 59 cm, ↓ 14 cm
 incl. SMD-LED, 58 W
 7.000 lm, 2.300 + 3.000 + 4.000 K



626210107
626210131
626210132

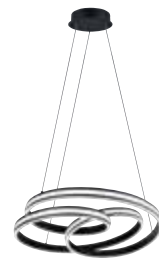

Pendelleuchte · Pendant
 Ø 60 cm, ↓ 150 cm
 incl. SMD-LED, 60 W
 7.200 lm, 2.300 + 3.000 + 4.000 K



326210107
326210131
326210132



YARA

Metall, Acryl · metal, acryl ·
metale, acryl · metaal, acryl · metal, acrílico ·
metallo, acrilico · metal, acrylic · metalli, akryyli · metal, akryl



Lichtfarbe einstellbar ·
Adjustable light color



07 | Nickel matt · nickel mat



31 | Weiß matt · white mat



32 | Schwarz matt · black mat



Stehleuchte · Floor lamp
↑ 150 cm, Ø 35 cm
incl. SMD-LED, 34 W
4.000 lm, 2.300 + 3.000 + 4.000 K



426219107
426219131
426219132



Deckenleuchte · Ceiling lamp
 Ø 53 cm, ↓ 23,5 cm
 incl. SMD-LED, 40 W
 4.400 lm, 3.000 K



621710107
 621710142



Stehleuchte · Floor lamp
 ↓ 180 cm, Ø 47 cm
 incl. SMD-LED, 25 W
 2.750 lm, 3.000 K



421710107
 421710142



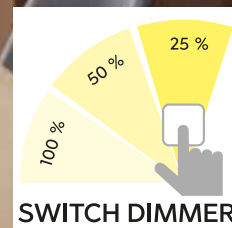

OAKLAND

Metall, Nickel matt oder Anthrazit · metal, nickel mat or anthracite ·
 metale, nickel mat ou antracite · metaal, nikkell mat of antraciet · metal, níquel mate o antracita ·
 metallo, nichel opaco o antracite · metal, nichel mat sau antracit · metalli, harjattu teräs tai antrasiitti ·
 metal, nikiel mat lub antracyt



07 | Nickel matt · nickel mat



42 | Anthrazit · anthracite



Pendelleuchte · Pendant
 Ø 71 cm, ↑ 150 cm
 incl. SMD-LED, 52 W
 5.650 lm, 3.000 K



321710107
 321710142

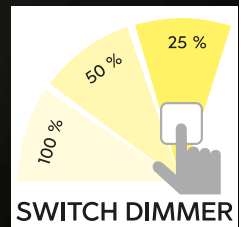

FRANCIS

Metall, Aluminium gebürstet, Weiß matt oder Anthrazit · metal, brushed aluminium, white mat or anthracite ·
 metale, aluminium balayé, blanc mat ou antracite · metaal, geborsteld aluminium, wit mat of antraciet ·
 metal, aluminio pulido, estera blanca o antracita · metallo, alluminio spazzolato, bianco opaco o antracite ·
 metal, aluminiu lucios, alb mat sau antracit · metalli, harjattu alumiini, mattavalkoinen tai antrasiitti ·
 metal, aluminium szczotkowane, biały mat lub antracyt



05 | Aluminium gebürstet · brushed aluminium

31 | Weiß matt · white mat

42 | Anthrazit · anthracite



Deckenleuchte · Ceiling lamp

↔ 54 x 52 cm, ↑ 19,5 cm
 incl. SMD-LED, 40 W
 6.000 lm, 3.000 K



671310105
 671310131
 671310142



Pendelleuchte · Pendant

↔ 72 x 68 cm, ↑ 150 cm
 incl. SMD-LED, 52 W
 6.500 lm, 3.000 K



371310105
 371310131
 371310142



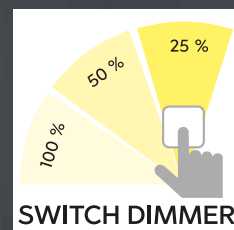
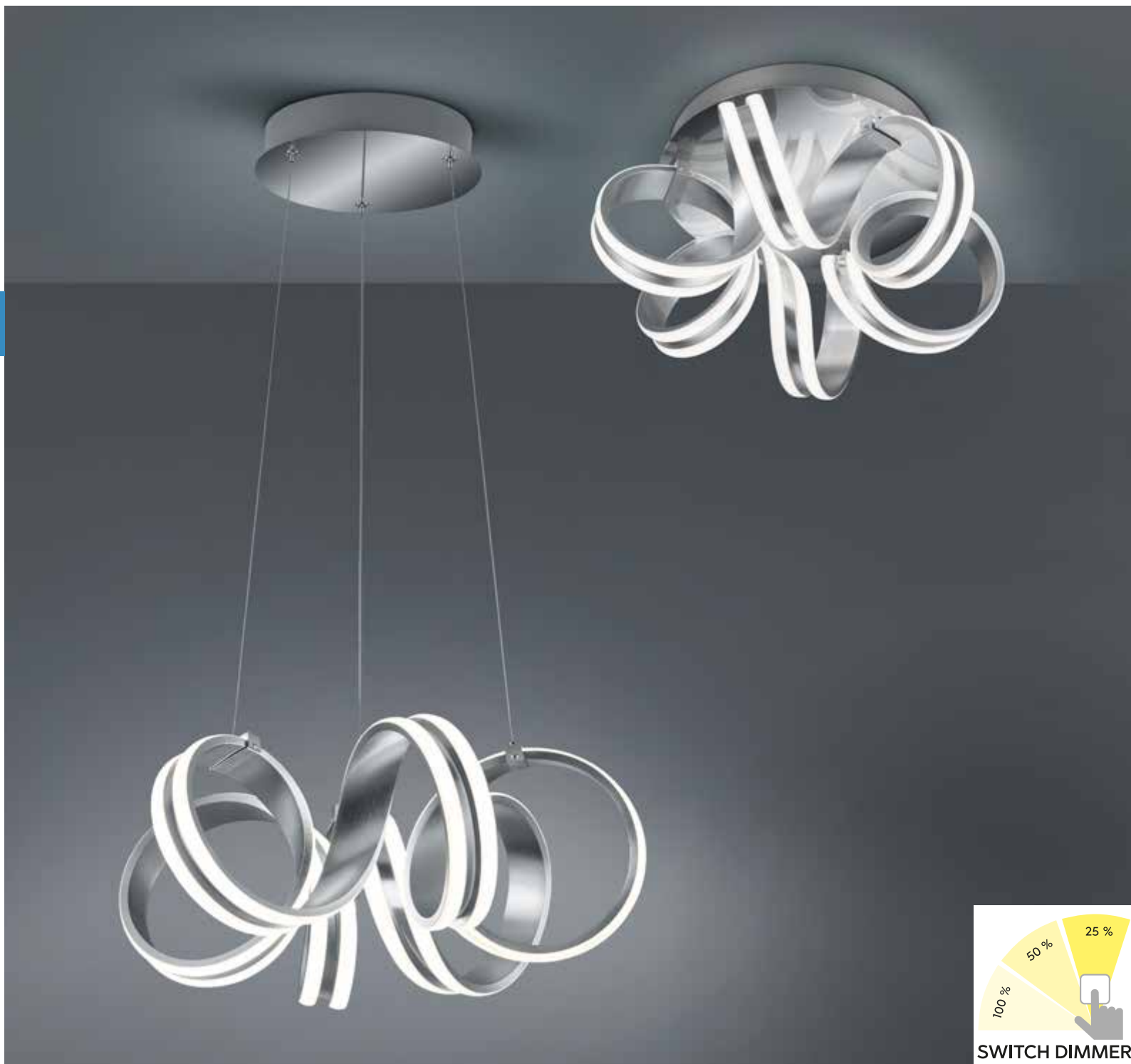

CARRERA

Metall, Acryl · metal, acryl ·
metale, acryl · metaal, acryl · metal, acrílico ·
metallo, acrilico · metal, acrylic · metalli, akryyli · metal, akryl



05 | Aluminium gebürstet · brushed aluminium



32 | Schwarz matt · black mat



Deckenleuchte · Ceiling lamp
Ø 45 cm, ↓ 22 cm
incl. SMD-LED, 38 W
4.400 lm, 3.000 K



625010105
625010132



Pendelleuchte · Pendant
↓ 150 cm, Ø 55 cm
incl. SMD-LED, 38 W
4.400 lm, 3.000 K



325010105
325010132





Getrennt schaltbar · Separately switchable

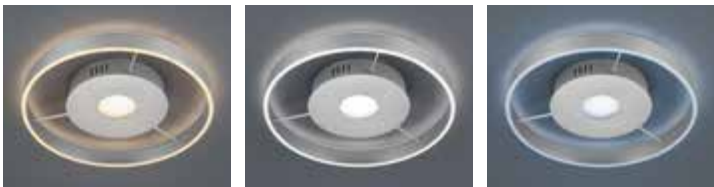

2.700 K

6.000 K

Deckenleuchte · Ceiling lamp

Ø 50 cm, ↑ 8 cm
incl. SMD-LED, 45 W
4.000 lm, 2.700 - 6.000 K



625710207
625710231
625710242



- 07** | Nickel matt · nickel mat
- 31** | Weiß matt · white mat
- 42** | Anthrazit · anthracite

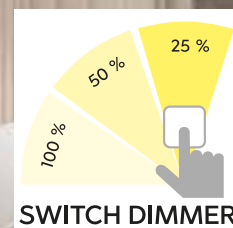

LOGAN

Metall, Nickel matt, Weiß matt oder Anthrazit · metal, nickel mat, white mat or anthracite ·
 metale, nickel mat, blanc mat ou antracite · metaal, nikkel mat, wit mat of antraciet ·
 metal, níquel mate, estera blanca o antracita · metallo, nichel opaco, bianco opaco o antracite ·
 metal, nichel mat, alb mat sau antracit · metalli, harjattu teräs, mattavalkoinen tai antrasiitti ·
 metal, nikiel mat, biały mat lub antracyt



LIFT ME

Innovative Höhenverstellung ohne Gegengewicht ·
 Innovative height adjustment without counterweight ·
 Nouveau! Réglage de la hauteur sans contrepoids ·
 Innovatieve hoogteverstelling zonder contragewicht ·
 Innovador sistema de ajuste de altura sin necesidad de contrapeso ·
 Regolazione innovativa dell'altezza senza contrappeso ·
 Ajustare inovativa a înalțimii fara contragreutate ·
 Innovatiivinen korkeuden säätö ilman vastapainoa ·
 Innowacyjna regulacja wysokości bez przeciwwagi



Deckenleuchte · Ceiling lamp
 Ø 54 cm, ↓ 150 cm
 incl. SMD-LED, 45 W
 4.000 lm, 3.000 K (31 = 4.000 K)





325710207
 325710231
 325710242



JIVE

Metall, Acryl · metal, acryl ·
 metale, acryl · metaal, acryl · metal, acrílico ·
 metallo, acrilico · metal, acrilic · metalli, akryyli ·
 metal, akrýl

-  **07** | Nickel matt · nickel mat
-  **31** | Weiß matt · white mat
-  **32** | Schwarz matt · black mat



Deckenleuchte · Ceiling lamp
 ↔ 50 x 45,5 cm, ↓ 7,6 cm cm
 incl. SMD-LED, 36 W
 4.300 lm, 2.700 - 6.000 K



623410207
623410231
623410232



Deckenleuchte · Ceiling lamp
 ↔ 80 x 73 cm, ↓ 7,6 cm
 incl. SMD-LED, 48 W
 5.600 lm, 2.700 - 6.000 K



623419207
623419231
623419232



Stehleuchte · Floor lamp
 ↓ 118 cm, ↔ 32 x 24 cm
 incl. SMD-LED, 23 W
 2.700 lm, 2.700 + 4.000 + 6.000 K



423410107
423410131
423410132



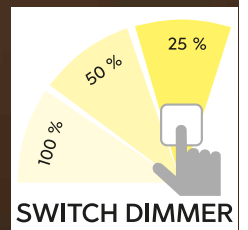

Pendelleuchte · Pendant
 Ø 62 cm, ↓ 150 cm
 incl. SMD-LED, 42 W
 5.100 lm, 3.000 K



321210107
321210108



Deckenleuchte · Ceiling lamp
 Ø 41 cm, ↓ 14 cm
 incl. SMD-LED, 20 W
 2.500 lm, 3.000 K



621210107
621210108



Deckenleuchte · Ceiling lamp
 Ø 62 cm, ↓ 18 cm
 incl. SMD-LED, 42 W
 5.100 lm, 3.000 K



621290107
621290108



CHARIVARI

Nickel matt oder Messing matt · nickel mat or brass mat ·
 nickel mat ou laiton mat · nikkel mat of messing mat ·
 níquel mate o bronze mate · nichel opaco o ottone satinato ·
 nichel mat sau bronz mat · harjattu teräs tai mattamessinki ·
 nikiel mat lub mosiądz mat



07 | Nickel matt · nickel mat

08 | Messing matt · brass mat



Tischleuchte · Table lamp
 ↓ 50 cm, Ø 41 cm
 incl. SMD-LED, 20 W
 2.500 lm, 3.000 K



521210107
 521210108



Stehleuchte · Floor lamp
 ↓ 175 cm, Ø 52 cm
 incl. SMD-LED, 31 W
 3.700 lm, 3.000 K



421210107
 421210108

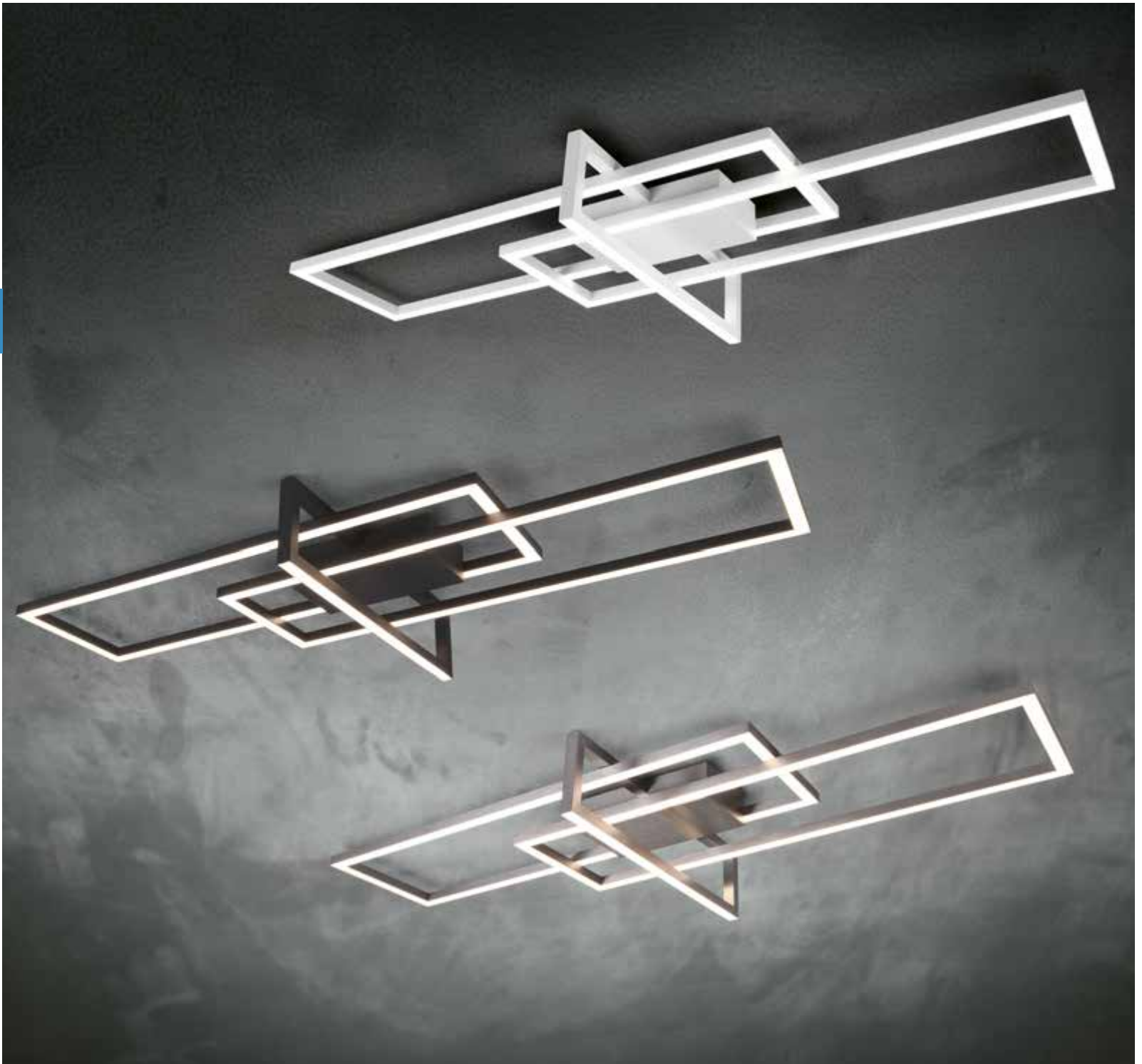

Deckenleuchte · Ceiling lamp

↔ 100 x 40 cm, ↑ 11,5 cm
incl. SMD-LED, 34 W
3.900 lm, 3.000 K
(**31** = 4.100 lm, 4.000 K)



620310307
620310308
620310331
620310332

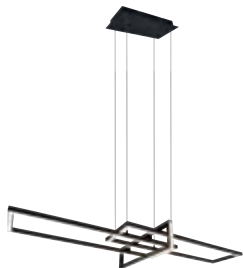

Pendelleuchte · Pendant

↓ max. 150 cm, ↔ 110 x 40 cm
incl. SMD-LED, 34 W
4.200 lm, 3.000 K
(**31** = 4.400 lm, 4.000 K)



320310307
320310308
320310331
320310332

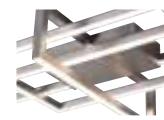

07 | Nickel matt · nickel mat

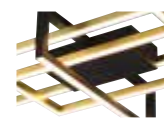

08 | Messing matt / Schwarz matt
brass matt / black mat

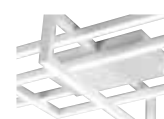

31 | Weiß matt · white mat

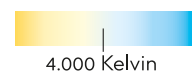

4.000 Kelvin



32 | Schwarz matt · black mat



SALINAS

Metall · metal ·
metale · metaal · metal ·
metallo · metal · metalli · metal

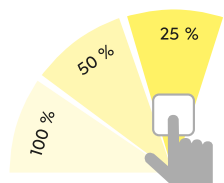

SWITCH DIMMER





Pendelleuchte · Pendant
 ↔ 118,5 x 19,3 cm, ↓ 150 cm
 incl. SMD-LED, 35 W
 4.100 lm, 2.300 + 3.000 + 4.000 K



326810131
326810132



Tischleuchte · Table lamp
 ↓ 44 cm, ↔ 21 x 17,5 cm
 incl. SMD-LED, 9 W
 950 lm, 2.300 + 3.000 + 4.000 K



526810131
526810132



Stehleuchte · Floor lamp
 ↓ 124 cm, ↔ 21 x 17,5 cm
 incl. SMD-LED, 26 W
 2.950 lm, 2.300 + 3.000 + 4.000 K



426810131
426810132

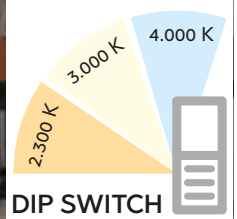

EDGE

Metall, Weiß matt oder Schwarz matt / Messing matt · metal, white mat or black mat / brass mat ·
 metale, blanc mat ou noir mat / laiton mat · metaal, wit mat of mat zwart / messing mat ·
 metal, estera blanca o estera negra / bronce mate · metallo, bianco opaco o nero opaco / ottone satinato ·
 metal, alb mat sau negru mat / bronz mat · metalli, mattavalkoinen tai mattamusta / mattamessinki ·
 metal, biały mat lub czarny mat / mosiądz mat



Lichtfarbe einstellbar ·
 Adjustable light color

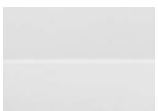

31 | Weiß matt · white mat



32 | Schwarz matt · black mat





TUCSON

Metall, Weiß matt · metal, white mat ·
 metale, blanc mat · metaal, wit mat · metal, estera blanca ·
 metallo, bianco opaco · metal, alb mat · metalli, valkoinen matto ·
 metal, biały mat

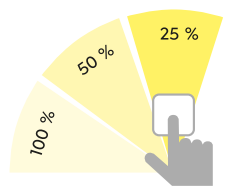

SWITCH DIMMER



Deckenleuchte · Ceiling lamp
 ↔ 104 x 42 cm, ↑ 8,5 cm
 incl. SMD-LED, 35 W
 3.300 lm, 3.000 K



672610331

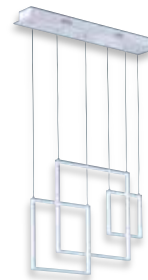

Pendelleuchte · Pendant
 ↔ 70 x 13 cm, ↑ 150 cm
 incl. SMD-LED, 26 W
 2.200 lm, 3.000 K



372610331



Stehleuchte · Floor lamp
 ↑ 161 x 18 cm, ↔ 44,5 cm
 incl. SMD-LED, 44 W
 3.750 lm, 3.000 K



472610531





Deckenleuchte · Ceiling lamp

↔ 52,5 x 52,5 cm, ↑ 16 cm
incl. SMD-LED, 24 W
2.400 lm, 3.000 K



627710405

627710432

54



Deckenleuchte · Ceiling lamp

↔ 120,5 x 48,5 cm, ↑ 6 cm
incl. SMD-LED, 34 W
3.400 lm, 3.000 K



627710505

627710532

SORRENTO

Metall · metal ·
metale · metaal · metal · metallo · metal · metalli · metal

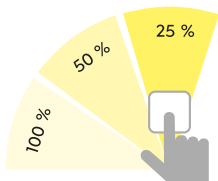

SWITCH DIMMER



05 | Aluminium gebürstet ·
brushed aluminium



32 | Schwarz matt ·
black mat



Stehleuchte · Floor lamp

↑ 125 x 12,5 cm, ↔ 48 cm
incl. SMD-LED, 34 W
3.400 lm, 3.000 K



427710505

427710532



Tischleuchte · Table lamp

↑ 50 x 13 cm, ↔ 24 cm
incl. SMD-LED, 15 W
1.500 lm, 3.000 K



527710305

527710332

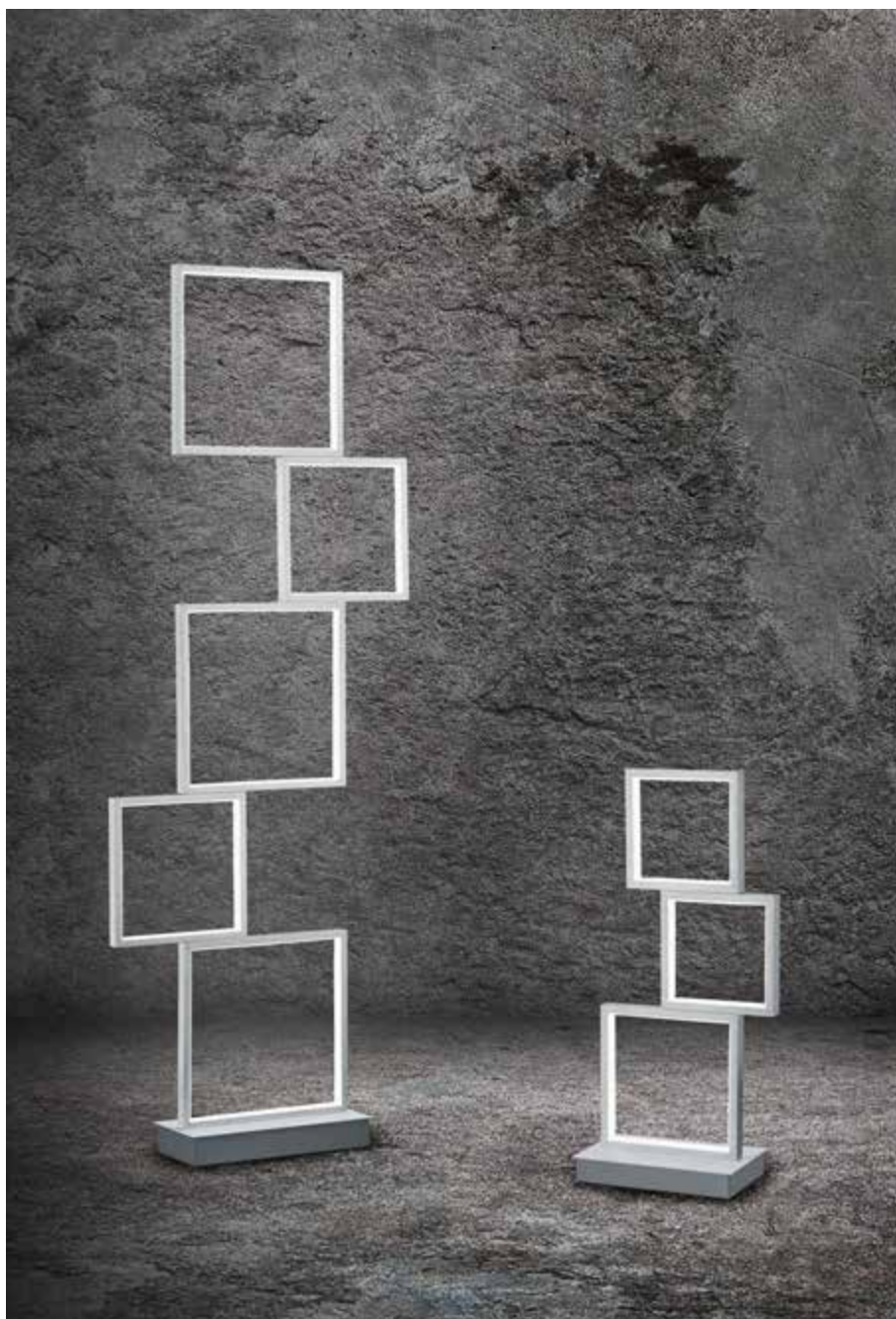

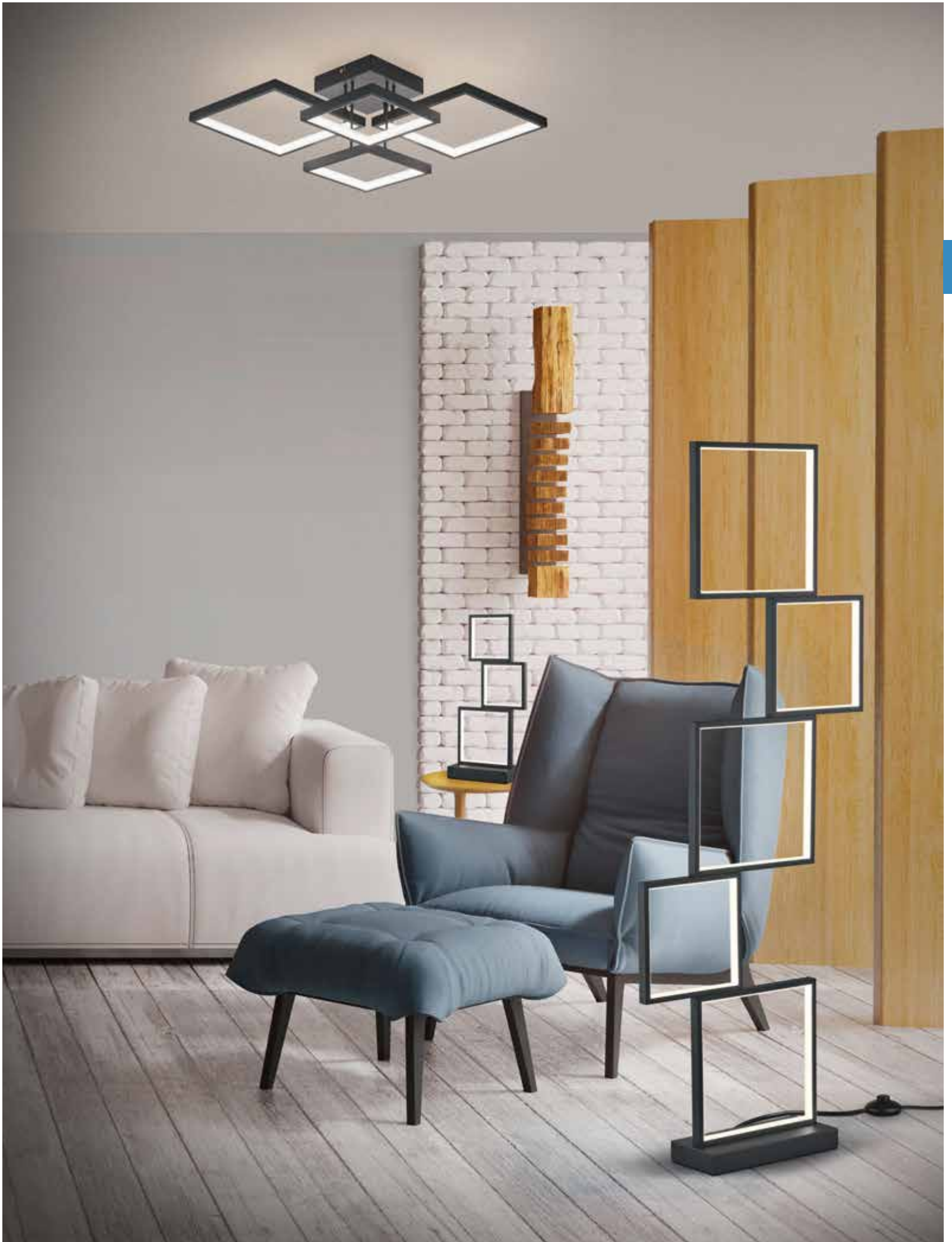

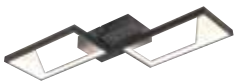

Deckenleuchte · Ceiling lamp
 ↔ 53,4 x 27,5 cm, ↓ 5,2 cm
 incl. SMD-LED, 14 W
 1.400 lm, 3.000 K



623210242

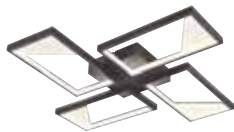

Deckenleuchte · Ceiling lamp
 ↔ 54,4 x 54,4 cm, ↓ 5,2 cm
 incl. SMD-LED, 28 W
 2.800 lm, 3.000 K



623210442



Tischleuchte · Table lamp
 ↓ 46,2 cm, ↔ 27,4 x 10 cm
 incl. SMD-LED, 14 W
 1.400 lm, 3.000 K



523210242





CAFU

Metall, Anthrazit / Weiß, Acryl · metal, anthracite / white, acryl ·
 metale, antracite / blanc, acryl · metaal, antraciet / wit, acryl ·
 metal, antracita / blanco, acrílico · metallo, antracite / bianco, acrilico ·
 metal, antracit / alb, acrilic · metalli, antrasiitti / valkoinen, akryyli ·
 metal, antracyt / biały, akryl

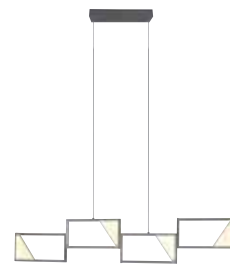
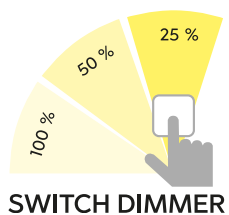

Pendelleuchte · Pendant
 ↔ 106,2 x 8,5 cm, ↓ 150 cm
 incl. SMD-LED, 28 W
 2.800 lm, 3.000 K



323210442

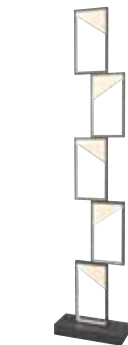

Stehleuchte · Floor lamp
 ↓ 130,5 cm, ↔ 28 x 12 cm
 incl. SMD-LED, 33 W
 3.300 lm, 3.000 K



423210542

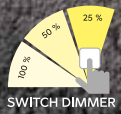

SWITCH DIMMER

BELFAST

Metall, Nickel matt oder Schwarz matt · metal, nickel mat or black mat ·
 metale, nikel mat ou noir mat · metaal, nikkel mat of mat zwart ·
 metal, níquel mate o estera negra · metallo, nichel opaco o nero opaco ·
 metal, nichel mat sau negru mat · metalli, harjattu teräs tai mattamusta ·
 metal, nikel mat lub czarny mat



07 | Nickel matt · nickel mat



32 | Schwarz matt · black mat



Wandleuchte · Wall lamp
 ↔ 60 x 30 cm, √ 7
 incl. 2 x SMD-LED, 10,5 W
 2 x 1.050 lm, 3.000 K



275510207
 275510232

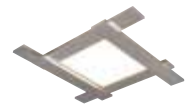

Deckenleuchte · Ceiling lamp
 ↔ 59 x 59 cm, ↓ 6,5 cm
 incl. SMD-LED, 18 W
 1.700 lm, 3.000 K
 incl. 4 x SMD-LED, 3,5 W
 4 x 350 lm, 3.000 K



675510507
 675510532

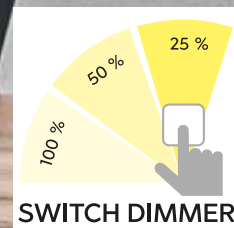

Pendelleuchte · Pendant
 ↔ 115,5 x 14,2 cm, ↓ 150 cm
 incl. SMD-LED, 44 W
 4.400 lm, 3.000 K



375510407
375510432

Gibt Licht nach oben und unten · up and down lighting ·
 point lumineux en haut et en bas · lichtpunt boven en onder · luz de arriba y abajo ·
 luce su e giù · sus și în jos lumina · ylös ja alas valoa · w górę iw dół światło

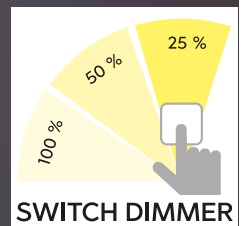

Pendelleuchte · Pendant
 ↔ 115,5 x 14,2 cm, ↓ 150 cm
 incl. SMD-LED, 44 W
 4.600 lm, 4.000 K

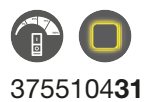

375510431

Gibt Licht nach oben und unten · up and down lighting ·
 point lumineux en haut et en bas · lichtpunt boven en onder · luz de arriba y abajo ·
 luce su e giù · sus și în jos lumina · ylös ja alas valoa · w górę iw dół światło



BELFAST

Metall, Weiß matt · metal, white mat ·
 metale, blanc mat · metaal, wit mat · metal, estera blanca ·
 metallo, bianco opaco · metal, alb mat · metalli, mattavalkoinen · metal, biały mat



Wandleuchte · Wall lamp

↔ 60 x 30 cm, ∠ 7
 incl. 2 x SMD-LED, 10,5 W
 2 x 1.100 lm, 4.000 K



275510231

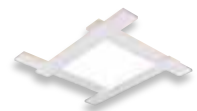

Deckenleuchte · Ceiling lamp

↔ 59 x 59 cm, ↓ 6,5 cm
 incl. SMD-LED, 18 W
 1.800 lm, 4.000 K
 incl. 4 x SMD-LED, 3,5 W
 4 x 380 lm, 4.000 K



675510531

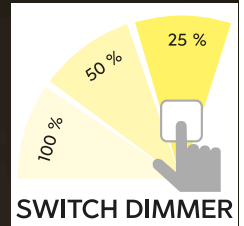



TIRIAC

Metall · metal ·
metale · metaal · metal · metallo · metal · metalli · metal





Deckenleuchte · Ceiling lamp
↔ 100 cm, ↑ 12 cm
incl. 3 x SMD, 8,5 W
3 x 950 lm, 3.000 K

 
671610307
671610331





Pendelleuchte · Pendant
↔ 60 cm, ↑ 150 cm
incl. 3 x SMD, 7,5 W
3 x 830 lm, 3.000 K

 
371690307
371690331



Pendelleuchte · Pendant
↔ 100 cm, ↑ 150 cm
incl. 3 x SMD, 8,5 W
3 x 950 lm, 3.000 K

 
371610307
371610331

 **07 | Nickel matt · nickel mat**

 **31 | Weiß matt · white mat**



100 % 50 % 25 %

SWITCH DIMMER

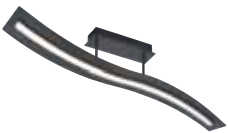

Deckenleuchte · Ceiling lamp
 ↔ 90 x 12 cm, ↓ 27,5 cm
 incl. SMD-LED, 24 W
 2.400 lm, 3.000 K
 (31 = 2.900 lm, 4.000 K)



624610131
 624610132
 624610179



Pendelleuchte · Pendant
 ↔ 115 x 12 cm, ↓ 150 cm
 incl. SMD-LED, 35 W
 3.500 lm, 3.000 K
 (31 = 4.100 lm, 4.000 K)



324610131
 324610132
 324610179



Stehleuchte · Floor lamp
 ↓ 140 cm, ↔ 22 x 22 cm
 incl. SMD-LED, 31 W
 2.900 lm, 3.000 K
 (31 = 3.700 lm, 4.000 K)



424610131
 424610132
 424610179



31 | Weiß matt · white mat

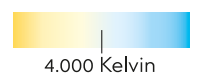

32 | Schwarz matt · black mat



79 | goldfarbig/rost · gold/rusty



SALERNO

Metall, weiß matt, schwarz matt oder goldfarbig/rost · metal, white mat, black mat or gold/rusty ·
 metale, blanc mat, noir mat ou or/rouill · metaal, wit mat, mat zwart of goud/roestkleur ·
 metal, estera blanca, estera negra o oro/óxido · metallo, bianco opaco, nero opaco o oro/ruggine ·
 metal, alb mat, negru mat sau aur/ruginiu · metalli, mattavalkoinen, mattamusta tai kultaa/rustiikki ·
 metal, biały mat, czarny mat lub złota/miedź

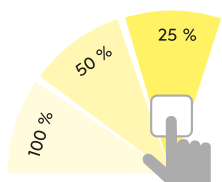

SWITCH DIMMER



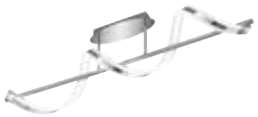

Deckenleuchte · Ceiling lamp
 ↔ 103 x 18 cm, ↑ 27 cm
 incl. SMD-LED, 20 W
 1.800 lm, 3.000 K



672910106



Tischleuchte · Table lamp
 ↑ 63 cm, Ø 20 cm
 incl. SMD-LED, 14,5 W
 1.300 lm, 3.000 K



572910106



Stehleuchte · Floor lamp
 ↑ 162 cm, Ø 25 cm
 incl. SMD-LED, 20 W
 1.800 lm, 3.000 K



472910106





SYDNEY

Chrom, Acryl · chrome, acryl ·
 chrome, acryl · chroom, acryl · cromo, acrílico · cromo, acrilico ·
 crom, acrylic · kromi, akryyli · chrom, akryl



Höhenverstellbar · Adjustable height
 Hauteur réglable · In hoogte verstelbaar ·
 Altura regulable · Altezza regolabile ·
 Inaltime reglabila · Säädettävä korkeus ·
 Regulowana wysokość



Pendelleuchte · Pendant
 ↔ 103 x 18 cm, ↑ 80 - 130 cm
 incl. SMD-LED, 20 W
 1.800 lm, 3.000 K



372910106

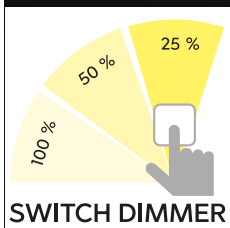
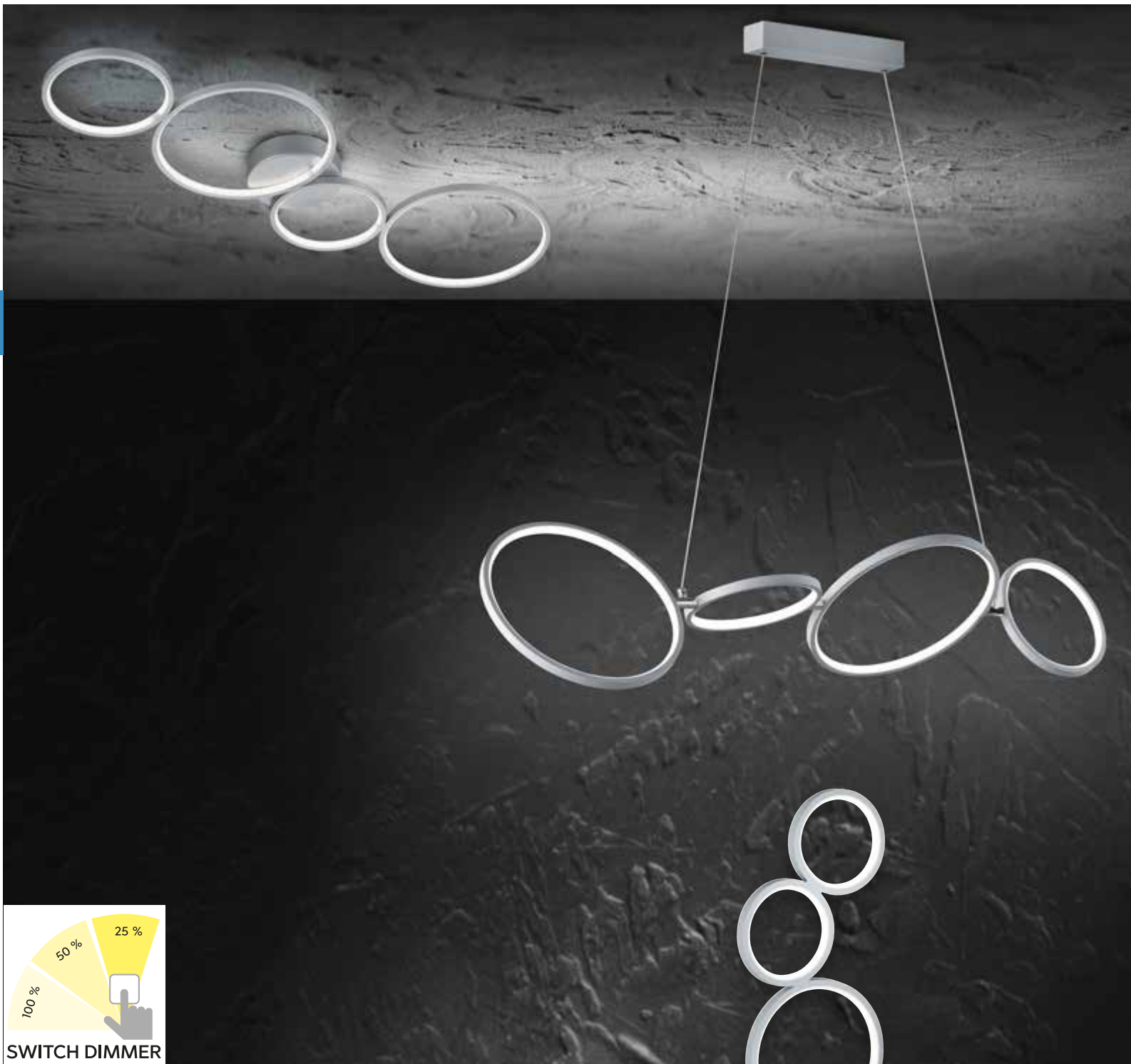

RONDO

Metall, silberfarbig · metal, silver ·
metale, argent · metaal, zilver · metal, plata · metallo, argento ·
metal, argint · metalli, hopea · metal, srebrny



Deckenleuchte · Ceiling lamp
↔ 59 x 53 cm, ↓ 5,5 cm
incl. SMD-LED, 49 W
5.800 lm, 3.000 K



622610589



Deckenleuchte · Ceiling lamp
↔ 97 x 34,3 cm, ↓ 5,5 cm
incl. SMD-LED, 37 W
4.800 lm, 3.000 K



622610489

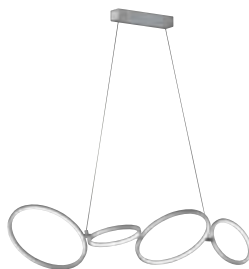

Pendelleuchte · Pendant
↔ 110 x 30 cm, ↓ 150 cm
incl. SMD-LED, 37 W
4.600 lm, 3.000 K



322610489



Tischleuchte · Table lamp
↓ 45 cm, ↔ 20,7 cm
incl. SMD-LED, 17 W
1.900 lm, 3.000 K



522610389



Stehleuchte · Floor lamp
↓ 115 cm, ↔ 47 cm
incl. SMD-LED, 36 W
4.700 lm, 3.000 K



422610589

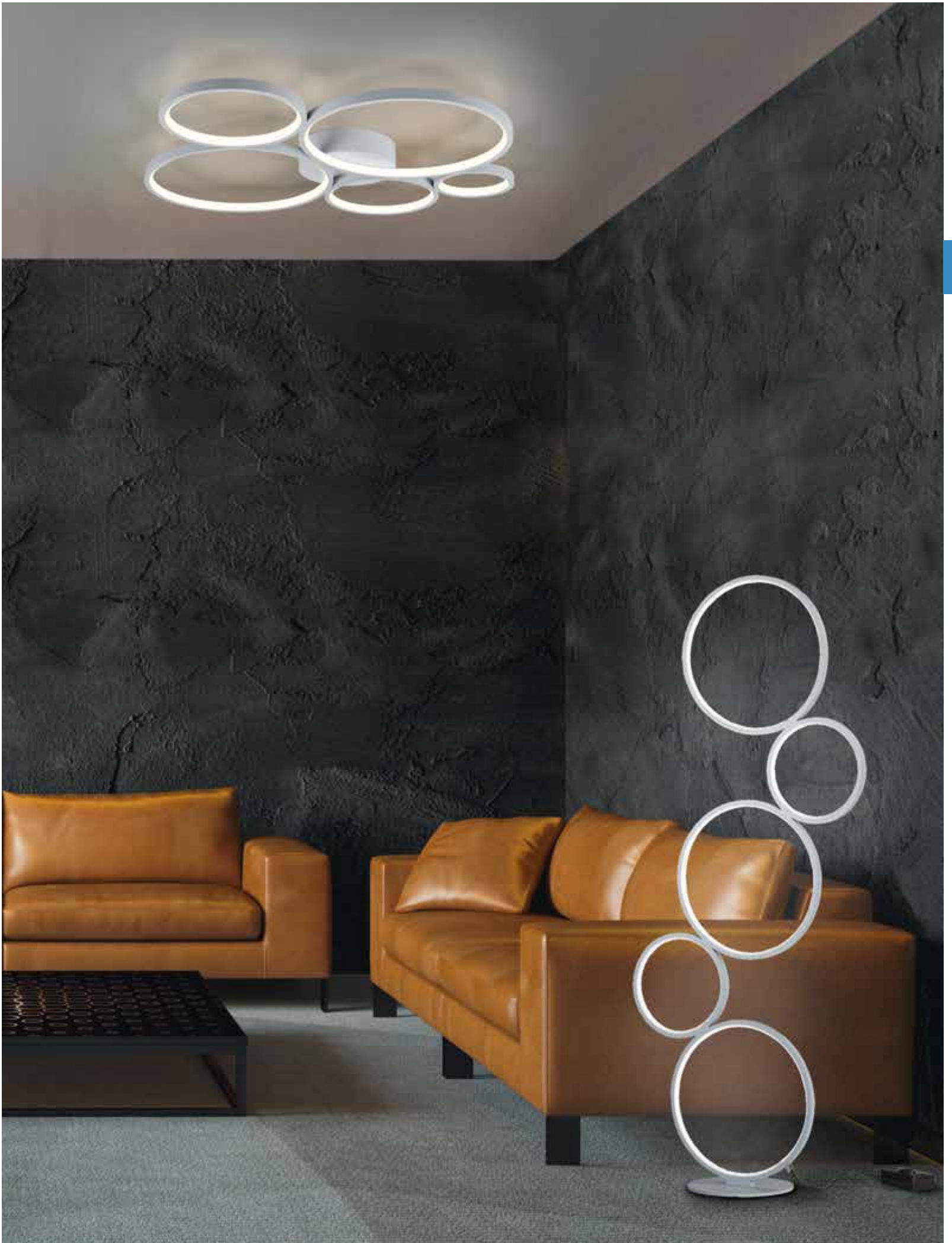

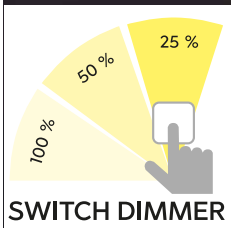

Deckenleuchte · Ceiling lamp
 ↔ 53 x 59 cm, ↑ 5,5 cm
 incl. SMD-LED, 49 W
 5.800 lm, 3.000 K



622610531
622610532



Deckenleuchte · Ceiling lamp
 ↔ 97 x 34,3 cm, ↑ 5,5 cm
 incl. SMD-LED, 37 W
 4.800 lm, 3.000 K



622610431
622610432

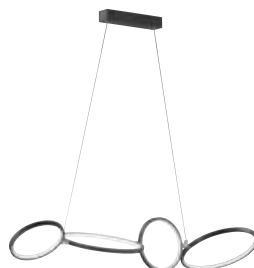

Pendelleuchte · Pendant
 ↔ 110 x 30 cm, ↑ 150 cm
 incl. SMD-LED, 37 W
 4.600 lm, 3.000 K



322610431
322610432



Tischleuchte · Table lamp
 ↑ 45 cm, ↔ 20,7 cm
 incl. SMD-LED, 17 W
 1.900 lm, 3.000 K



522610331
522610332



RONDO

Metall, Weiß matt oder Schwarz matt · metal, white mat or black mat ·
 metale, blanc mat ou noir mat · metaal, wit mat of mat zwart ·
 metal, estera blanca o estera negra · metallo, bianco opaco o nero opaco ·
 metal, alb mat sau negru mat · metalli, mattavalkoinen tai mattamusta ·
 metal, biały mat lub czarny mat



31 | Weiß matt · white mat



32 | Schwarz matt · black mat



Stehleuchte · Floor lamp
 ↑ 115 cm, ↔ 47 cm
 incl. SMD-LED, 36 W
 4.700 lm, 3.000 K



422610531
 422610532



Pendelleuchte · Pendant
 ↑ 150 cm, ↔ 30 cm
 incl. SMD-LED, 22 W
 1.950 lm, 3.000 K



322610231
 322610232



Deckenleuchte · Ceiling lamp

↔ 90 x 25 cm, ↑ 9 cm
incl. SMD-LED, 35 W
3.700 lm, 3.000 K



629010107
629010132



Stehleuchte · Floor lamp

↑ 112 cm, ↔ 29 x 25 cm
incl. SMD-LED, 35 W
3.700 lm, 3.000 K



429010107
429010132





AVUS

Metall, Nickel matt oder Schwarz matt · metal, nickel mat or black mat ·
 metale, nickel mat ou noir mat · metaal, nikkell mat of mat zwart · metal, níquel mate o estera negra ·
 metallo, nichel opaco o nero opaco · metal, nichel mat sau negru mat · metalli, harjattu teräs tai mattamusta ·
 metal, nikiel mat lub czarny mat

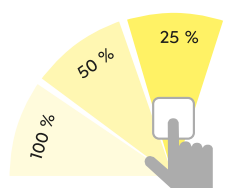

SWITCH DIMMER



07 | Nickel matt · nickel mat



32 | Schwarz matt · black mat



Pendelleuchte · Pendant
 ↑ 150 cm, ↔ 110 x 10 cm
 incl. SMD-LED, 35 W
 3.700 lm, 3.000 K



329010107
 329010132

LOOP

Nickel matt · nickel mat ·
nickel mat · nikkellat · níquel mate · nichel opaco ·
nichel mat · harjattu teräs · nikiel mat



Lichtfarbe einstellbar ·
Adjustable light color



4 fach TOUCH ·
4 level Touch function



Pendelleuchte · Pendant
↔ 117 x 15 cm, ↓ 150 cm
incl. 3 x SMD-LED, 9 W
3 x 850 lm, 3.000 + 5.000 K



379890307



Tischleuchte · Table lamp
↑ 57 cm, Ø 16 cm
incl. 3 x SMD-LED, 4,5 W
3 x 300 lm, 3.000 + 5.000 K



579890307



Stehleuchte · Floor lamp
↑ 138 cm, Ø 23 cm
incl. 3 x SMD-LED, 9 W
3 x 850 lm, 3.000 + 5.000 K



479890307



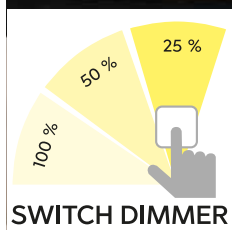

OLYMPUS

Chrom, Aluminium · chrome, aluminium ·
 chrome, aluminium · chroom, aluminium ·
 cromo, aluminio · cromo, alluminio · crom, aluminu ·
 kromi, alumiini · chrom, aluminium



Pendelleuchte · Pendant
 ↔ 115 x 17,5 cm, ↓ 150 cm
 incl. 6 x SMD-LED, 4,2 W
 6 x 450 lm, 3.000 K



370910606



Stehleuchte · Floor lamp
 ↓ 165 cm, ↔ 21 cm
 incl. 4 x SMD-LED, 4,2 W
 4 x 450 lm, 3.000 K



470910406



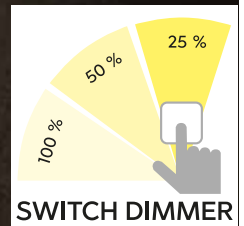

DEACON

Metall, Nickel matt oder Schwarz matt, Holz · metal, nickel mat or black mat, wood ·
 metale, nickel mat ou noir mat, bois · metaal, nikkell mat of mat zwart, hout · metal, níquel mate o estera negra, madera ·
 metallo, nichel opaco o nero opaco, di legno · metal, nichel mat sau negru mat, lemn · metalli, harjattu teräs tai mattamusta, puu ·
 metal, nikiel mat lub czarny mat, drewno

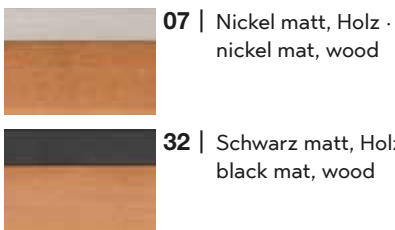

07 | Nickel matt, Holz ·
 nickel mat, wood

32 | Schwarz matt, Holz ·
 black mat, wood

Deckenleuchte · Ceiling lamp
 Ø 50 cm, ↓ 7 cm
 incl. SMD-LED, 37 W
 4.400 lm, 3.000 K



626610207
 626610232



Lichtfarbe einstellbar ·
Adjustable light color



Sensordimmer ·
Sensor dimmer

Pendelleuchte · Pendant
↔ 110 x 6,5 cm, ↑ 150 cm
incl. SMD-LED, 40 W
3.200 lm, 2.700 + 4.000 + 6.500 K



326610207
326610232

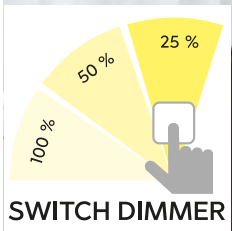
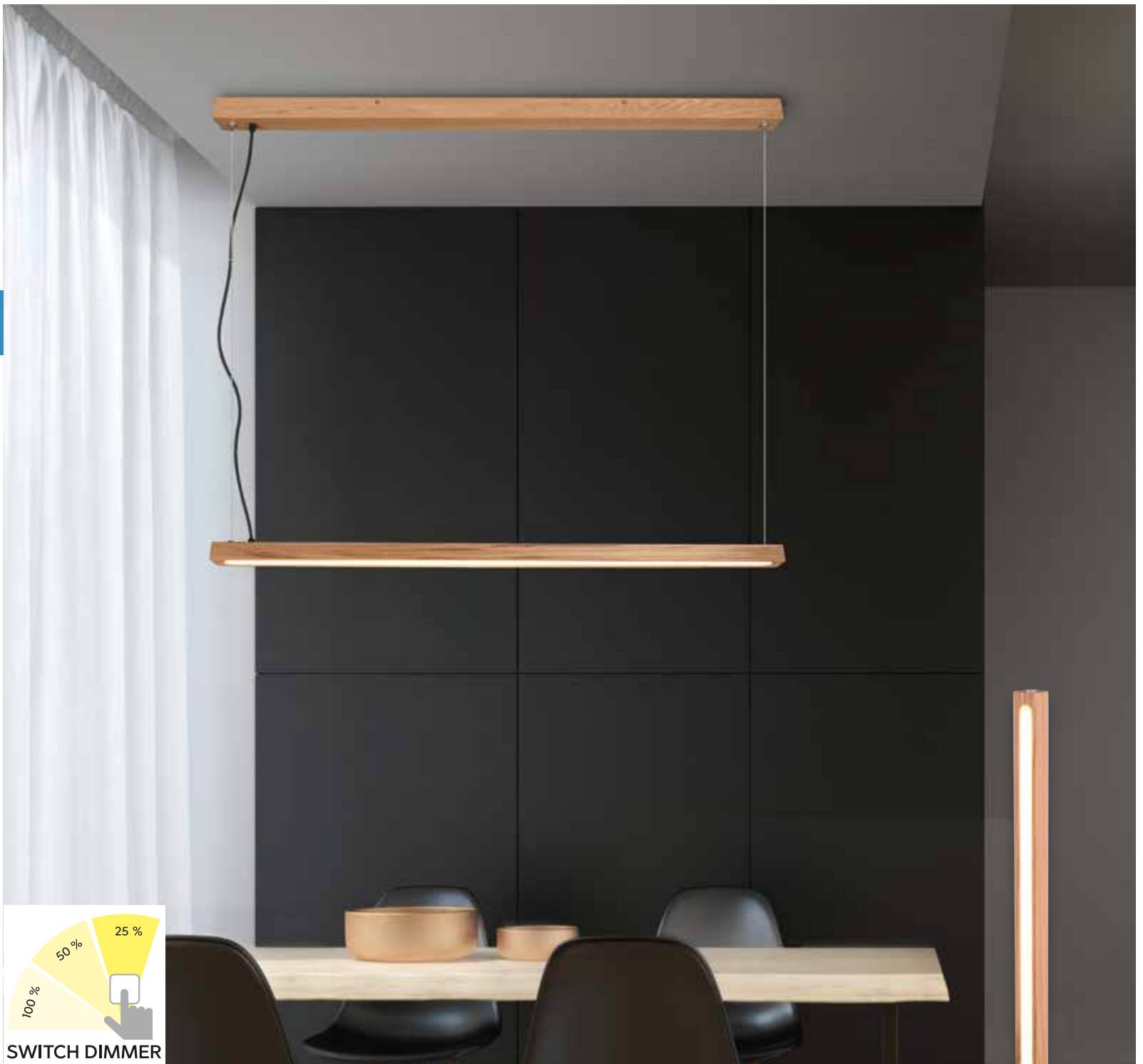

Pendelleuchte · Pendant
 ↔ 115 x 6,5 cm, ↓ 150 cm
 incl. SMD-LED, 27,5 W
 3.150 lm, 3.000 K



326410130



Stehleuchte · Floor lamp
 ↓ 115 cm, ↔ 22 x 22 cm
 incl. SMD-LED, 20 W
 2.300 lm, 3.000 K



426410130



4 fach TOUCH ·
 4 level Touch function





BELLARI

Holz, Metall Schwarz matt · wood, metal black mat ·
 bois, metale noir mat · hout, metaal mat zwart · madera, metal estera negra ·
 di legno, metallo nero opaco · lemn, metal negru mat · puu, metalli mattamusta ·
 drewno, metal czarny mat



Lichtfarbe stufenlos einstellbar ·
 Light color infinitely variable



Integrierter Dimmer ·
 Integrated dimmer



2.700 K

6.000 K

Deckenleuchte · Ceiling lamp

↔ 180 x 10 cm, ↑ 13,5 cm
 incl. SMD-LED, 36 W
 4.200 lm, 2.700 - 6.000 K



626410530



Deckenleuchte · Ceiling lamp

Ø 50 cm, ↑ 35 cm
excl. 3 x E27, max. 40 W



608300308

80

CAMDEN

Messing matt, Stoffschirm · brass mat, fabric shade ·
laiton mat, abat-jour tissu · messing mat, Stoffen kap ·
bronze mate, Pantalla de tela · ottone satinato, paralume in tessuto ·
bronz mat, abajur textil · mattamessinki, kangas varjostin ·
mosiądz mat, Klosz z materiału



Pendelleuchte · Pendant

Ø 50 cm, ↑ 150 cm
excl. 3 x E27, max. 40 W



308300308



Stehleuchte · Floor lamp

↑ 145 - 180 cm, Ø 50 cm
excl. 3 x E27, max. 40 W



408300308



Höhenverstellbar ·
Adjustable height



Getrennt schaltbar ·
Separately switchable



↑ ↓



Deckenleuchte · Ceiling lamp
 Ø 50 cm, ↑ 35 cm
 excl. 3 x E27, max. 40 W



608300307

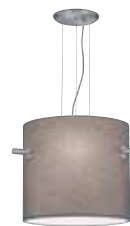

Pendelleuchte · Pendant
 Ø 50 cm, ↑ 150 cm
 excl. 3 x E27, max. 40 W



308300307



Stehleuchte · Floor lamp
 ↑ 145 - 180 cm, Ø 50 cm
 excl. 3 x E27, max. 40 W



408300307



CAMDEN

Nickel matt, Stoffschirm · nickel mat, fabric shade ·
 nickel mat, abat-jour tissu · nikkel mat, Stoffen kap · níquel mate, Pantalla de tela ·
 nichel opaco, paralume in tessuto · nichel mat, abajur textil · harjattu teräs, kangas varjostin ·
 nikiel mat, Klosz z materiału



Höhenverstellbar ·
Adjustable height



Getrennt schaltbar ·
Separately switchable



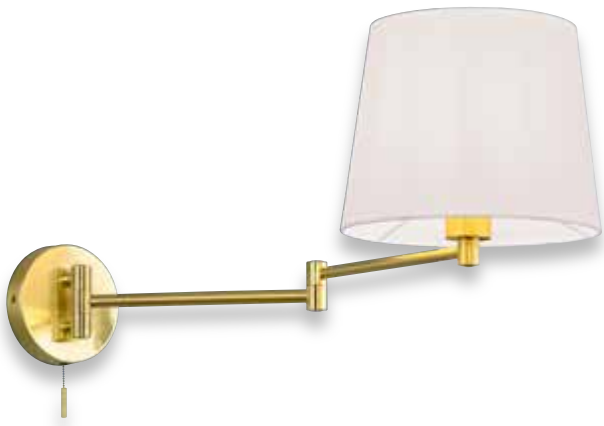

Wandleuchte · Wall lamp

↓ 32,5 x 25,5 cm, ↗ 69 cm
excl. 1 x E27, max. 60 W



209100107
209100108

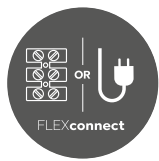

Seite/page 648



07 | Nickel matt · nickel mat



08 | Messing matt · brass mat



Tischleuchte · Table lamp

↓ 45 - 56 cm, Ø 25,5 cm
excl. 1 x E27, max. 60 W



509100107
509100108





LYON

Nickel matt oder Messing matt, Stoffschirm · nickel mat or brass mat, fabric shade ·
 nickel mat ou laiton mat, abat-jour tissu · nikkel mat of messing mat, Stoffen kap ·
 níquel mate o bronce mate, Pantalla de tela · nichel opaco o ottone satinato, paralume in tessuto ·
 nichel mat sau bronz mat, abajur textil · harjattu teräs tai mattamessinki, kangas varjostin ·
 nikiel mat lub mosiądz mat, Klosz z materiału



Getrennt schaltbar · Separately switchable ·
 Interrupteurs séparés · Gescheiden schakelbaar ·
 Interruptores separados · Interruttori separati ·
 Intrerupatoare separate · Erikseen kytkettävissä ·
 Oddzileny przełącznik



Stehleuchte · Floor lamp
 ↑ 138 - 180 cm, Ø 46,3 cm
 excl. 3 x E27, max. 60 W



409100307
 409100308



Pendelleuchte · Pendant
 ↔ 90 x 20 cm, ↑ 95 - 160 cm
 incl. 3 x SMD-LED, 7,5 W
 3 x 750 lm, 3.000 K



378010307
 378010308



Pendelleuchte · Pendant
 ↔ 115 x 20 cm, ↑ 95 - 160 cm
 incl. 4 x SMD-LED, 7,5 W
 4 x 750 lm, 3.000 K



378010407
 378010408



Tischleuchte · Table lamp
 ↓ 32 cm, Ø 20 cm
 incl. 1 x SMD-LED, 7,5 W
 750 lm, 3.000 K



578090107
 578090108



LIFT ME
 Innovative Höhenverstellung ohne Gegengewicht ·
 Innovative height adjustment without counterweight ·
 Nouveau! Réglage de la hauteur sans contrepoids ·
 Innovatieve hoogterverstelling zonder contragewicht ·
 Innovador sistema de ajuste de altura sin necesidad de contrapeso ·
 Regolazione innovativa dell'altezza senza contrappeso ·
 Ajustare inovativa a inaltimei fara contragreutate ·
 Innovatiivinen korkeuden säätö ilman vastapainoa ·
 Innowacyjna regulacja wysokości bez przeciwwagi



AGENTO

Nickel matt oder Messing matt, Stoff · nickel mat or brass mat, fabric ·
 nickel mat ou laiton mat, tissu · nikkel mat of messing mat, textiel ·
 níquel mate o bronce mate, tela · nichel opaco o ottone satinato, tessuto ·
 nichel mat sau bronz mat, textil · harjattu teräs tai mattamessinki, tekstiili ·
 nikiel mat lub mosiądz mat, tkanina



Sensordimmer ·
 Sensor dimmer



07 | Nickel matt · nickel mat



08 | Messing matt · brass mat

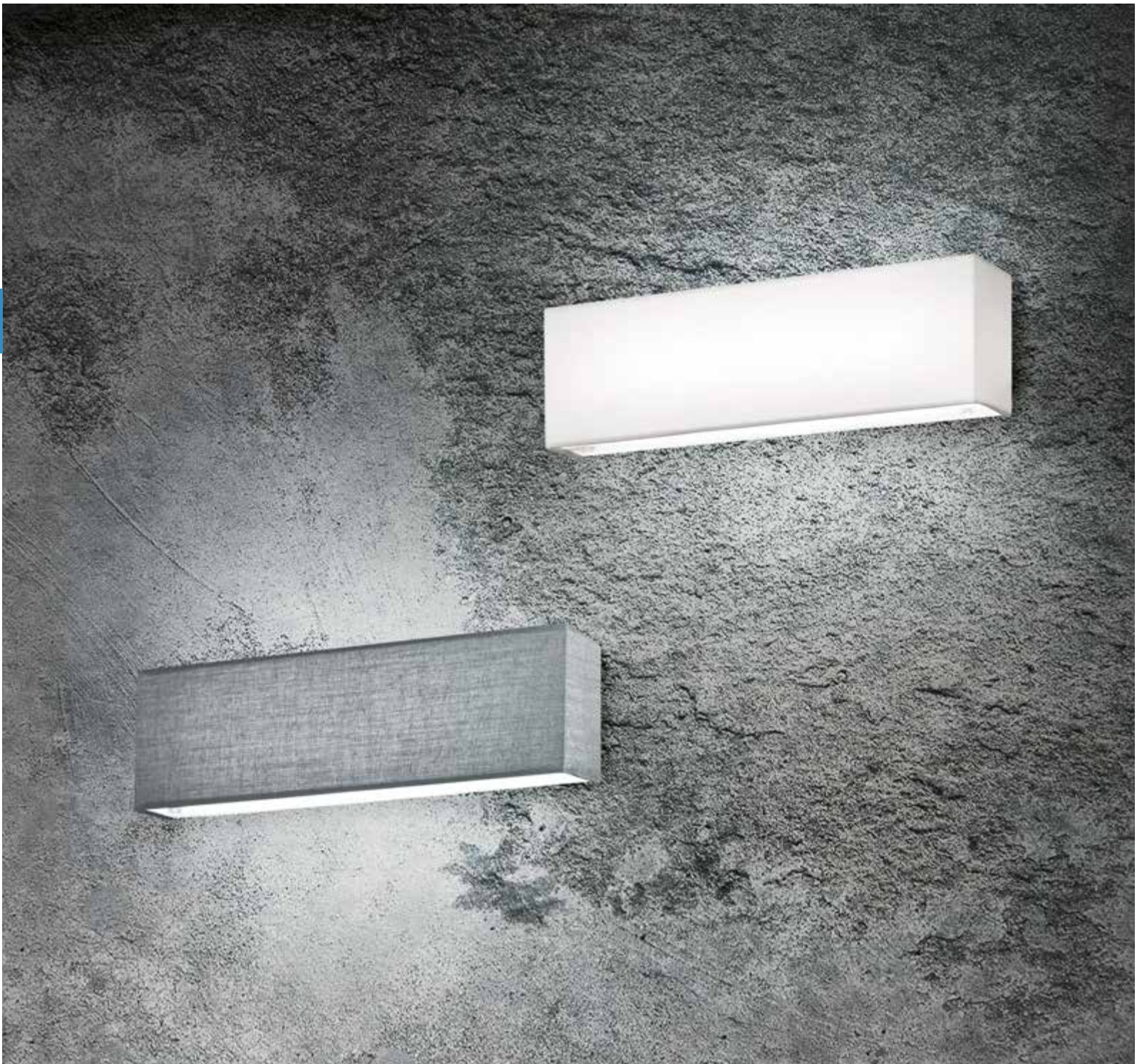

Wandleuchte · Wall lamp
 ↔ 25 x 8 cm, ↗ 7,5 cm
 incl. SMD-LED, 6 W
 580 lm, 3.000 K



271970601
271970611



Pendelleuchte · Pendant
 ↔ 100 x 8,5 cm, ↓ 150 cm
 incl. SMD-LED, 18 W
 1.500 lm, 3.000 K



320910101
320910111



01 | Weiß · white



11 | Grau · grey

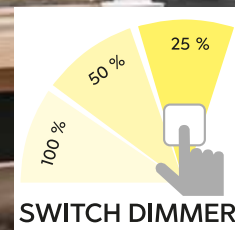

LUGANO

Nickel matt, Stoffschirm · nickel mat, fabric shade ·
 nickel mat, abat-jour tissu · nikkel mat, Stoffen kap · níquel mate, Pantalla de tela ·
 nichel opaco, paralume in tessuto · nichel mat, abajur textil ·
 harjattu teräs, kangas varjostin · nikiel mat, Klosz z materiału



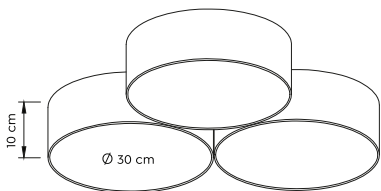
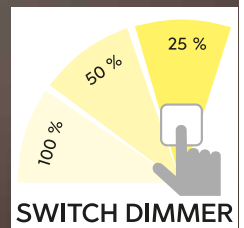

Deckenleuchte · Ceiling lamp

↔ 64,5 x 64,5 cm, ↑ 14 cm
incl. SMD-LED, 38 W
4.200 lm, 3.000 K



621910301 | Weiß · white
621910302 | Schwarz · black
621910317 | mehrfarbig · multicolor



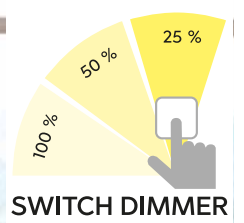

LUGANO

Stoffschirm, Acryl · fabric shade, acryl ·
abat-jour tissu, acryl · Stoffen kap, acryl ·
Pantalla de tela, acrílico · paralume in tessuto, acrilico ·
abajur textil, acrilic · kangas varjostin, akryyli ·
Klosz z materiału, akryl

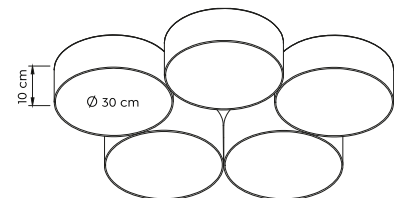
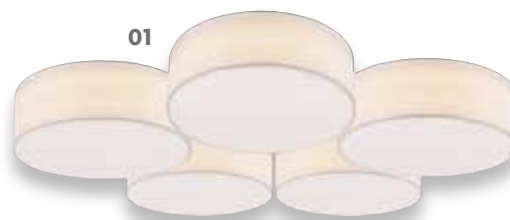

Deckenleuchte · Ceiling lamp

↔ 86,5 x 69 cm, ↓ 14 cm
incl. SMD-LED, 58 W
6.300 lm, 3.000 K



621910501 | Weiß · white
621910502 | Schwarz · black
621910517 | mehrfarbig · multicolor



 Lichtfarbe stufenlos einstellbar ·
Light color infinitely variable

 Integrierter Dimmer ·
Integrated dimmer

 Memory Funktion ·
Memory function



01 | Weiß · white



11 | Grau · grey



Deckenleuchte · Ceiling lamp
Ø 60 cm, ↑ 10 cm
incl. SMD-LED, 40 W
3.300 lm, 3.000 - 5.000 K



621914001
621914011



Deckenleuchte · Ceiling lamp
Ø 75 cm, ↑ 10 cm
incl. SMD-LED, 60 W
5.000 lm, 3.000 - 5.000 K



621915501
621915511

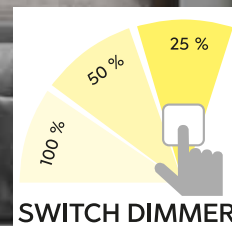

SWITCH DIMMER

LUGANO

Stoffschild, Acryl · fabric shade, acryl ·
abat-jour tissu, acryl · Stoffen kap, acryl · Pantalla de tela, acrílico ·
paralume in tessuto, acrilico · abajur textil, acrilic · kangas varjostin, akryyli ·
Klosz z materiału, akryl



01 | Weiß · white



11 | Grau · grey



Deckenleuchte · Ceiling lamp
Ø 30 cm, ↑ 9 cm
incl. SMD-LED, 11 W
1.100 lm, 3.000 K

621911201
621911211



Deckenleuchte · Ceiling lamp
Ø 40 cm, ↑ 10,5 cm
incl. SMD-LED, 22 W
2.200 lm, 3.000 K



621912401
621912411



HOTEL

Stoffschirm, mehrfarbig · fabric shade, multicolor ·
abat-jour tissu, multicolore · Stoffen kap, multicolor · Pantalla de tela, multicolor ·
paralume in tessuto, multicolore · abajur textil, multicolor · kangas varjostin, monivärinen · Klosz z materiału, multi-kolor

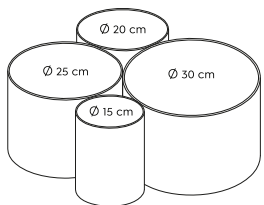

Deckenleuchte · Ceiling lamp
↔ 50,5 x 47 cm, ↓ 21,5 cm
excl. 4 x E27, max. 42 W



693900417

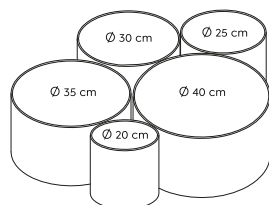

Deckenleuchte · Ceiling lamp
↔ 90 x 70 cm, ↓ 21,5 cm
excl. 5 x E27, max. 42 W



693900517

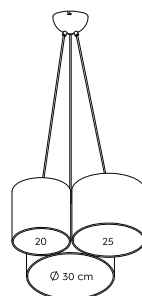

Pendelleuchte · Pendant
 ↔ 45,4 x 52,5 cm, ↓ 150 cm
 excl. 3 x E27, max. 42 W



393900317

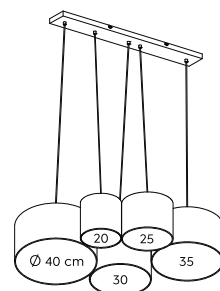

Pendelleuchte · Pendant
 ↔ 96,5 x 68,5 cm, ↓ 150 cm
 excl. 5 x E27, max. 42 W



393900517



01 | Weiß · white

02 | Schwarz · black

11 | Grau · grey

14 | Braun · brown



Deckenleuchte · Ceiling lamp
 Ø 30 cm, ↑ 16 cm
 excl. 2 x E14, max. 40 W



603900201
 603900202
 603900211
 603900214



Deckenleuchte · Ceiling lamp
 Ø 50 cm, ↑ 17 cm
 excl. 3 x E27, max. 60 W



603900301
 603900302
 603900311
 603900314



Deckenleuchte · Ceiling lamp
 Ø 65 cm, ↑ 17 cm
 excl. 5 x E27, max. 60 W



603900501
 603900502
 603900511
 603900514



HOTEL

Nickel matt, Stoff · nickel mat, fabric ·
 nickel mat, tissu · nikkell mat, textiel · níquel mate, tela ·
 nichel opaco, tessuto · nichel mat, textil · harjattu teräs, tekstiili · nikiel mat, tkanina

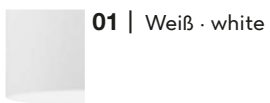

01 | Weiß · white



02 | Schwarz · black



11 | Grau · grey



Pendelleuchte · Pendant
 Ø 40 cm, ↓ 150 cm
 excl. 1 x E27, max. 60 W



303300101
303300102
303300111



Stehleuchte · Floor lamp

↑ 160 cm, Ø 35 cm
excl. 1 x E27, max. 60 W



401100101
401100102
401100111

HOTEL

Metall, Stoffschirm · metal, fabric shade ·
metale, abat-jour tissu · metaal, Stoffen kap ·
metal, Pantalla de tela · metallo, paralume in tessuto ·
metal, abajur textil · metalli, kangas varjostin ·
metal, Klosz z materiału



01 | Weiß · white



02 | Schwarz · black



11 | Grau · grey

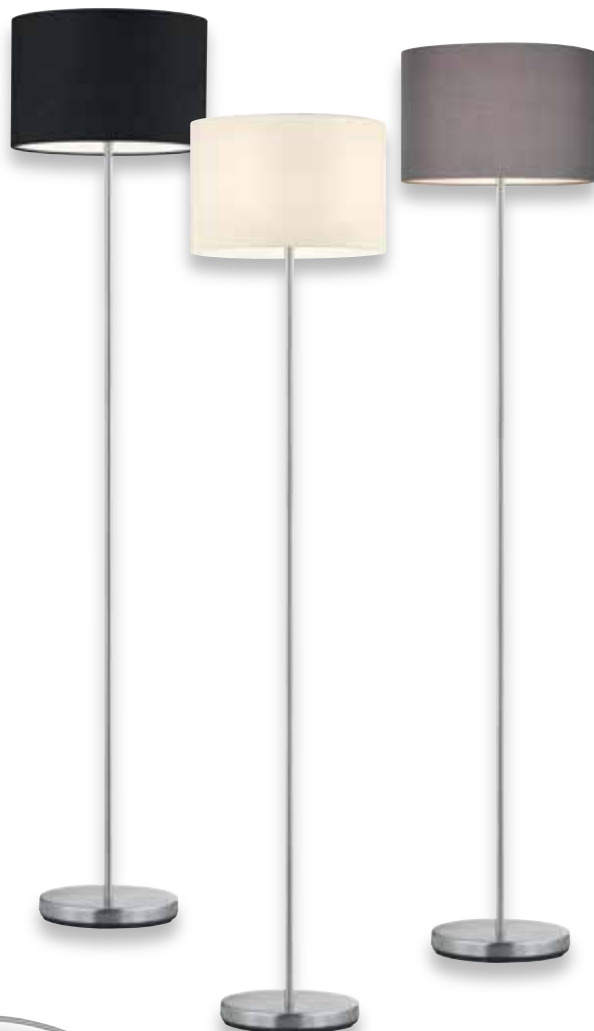

Stehleuchte · Floor lamp

↑ 150 - 215 cm, Ø 30 cm, √ 107 cm
excl. 1 x E27, max. 60 W



461100101
461100102
461100111



01 | Nickel matt, Schirm Weiß · nickel mat, shade white



08 | Messing matt, Schirm Creme-Weiß · brass mat, shade cream white



11 | Nickel matt, Schirm Grau · nickel mat, shade grey



Stehleuchte · Floor lamp
 ↑ 170 cm, Ø 40 cm, ↗ 35 cm
 excl. 1 x E27, max. 60 W
 excl. 1 x E14, max. 18 W



403900201
 403900208
 403900211



Wandleuchte · Wall lamp
 ↓ 23,5 x 20 cm, ↗ max. 34,5 cm
 incl. 1 x COB-LED, 3,1 W
 310 lm, 3.000 K
 excl. 1 x E14, max. 40 W

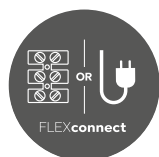

Seite/page 648



01 | Weiß · white



02 | Schwarz · black



11 | Grau · grey



14 | Braun · brown



Wandleuchte · Wall lamp
 ↓ 27,7 x 20 cm, ↗ max. 40 cm
 incl. 1 x SMD-LED, 3,1 W
 310 lm, 3.000 K
 excl. 1 x E14, max. 40 W

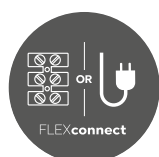

Seite/page 648



271170201
 271170202
 271170211
 271170214

271370201
 271370211
 271370214



HOTEL

Nickel matt, Stoff · nickel mat, fabric ·
 nickel mat, tissu · nikkel mat, textiel · níquel mate, tela ·
 nichel opaco, tessuto · nichel mat, textil · harjattu teräs, tekstiili ·
 nikiel mat, tkanina

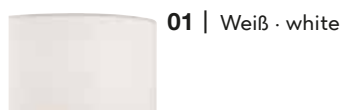

01 | Weiß · white

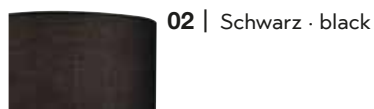

02 | Schwarz · black



11 | Grau · grey



Tischleuchte · Table lamp
 ↓ 32 cm, Ø 20 cm
 excl. 1 x E14, max. 40 W



501100101
 501100102
 501100111



Tischleuchte · Table lamp
 ↓ 55 cm, Ø 30 cm
 excl. 1 x E27, max. 60 W



511100101
 511100102
 511100111



IBIS

Stoffschild, Nickel matt · fabric shade, nickel mat ·
 abat-jour tissu, nickel mat · Stoffen kap, nikkell mat ·
 Pantalla de tela, níquel mate · paralume in tessuto, nichel opaco ·
 abajur textil, nichel mat · kangas varjostin, harjattu teräs ·
 Klosz z materiału, nikiel mat



Deckenleuchte · Ceiling lamp
 Ø 45 cm, ↓ 39,6 cm
 excl. 3 x E27, max. 40 W



609400317



Pendelleuchte · Pendant
 ↓ 150 cm, Ø 45 cm
 excl. 3 x E27, max. 40 W



309400317





Deckenleuchte · Ceiling lamp

↔ 75 x 44,2 cm, ↓ 22 cm
excl. 5 x E14, max. 25 W



605400501
605400511
605400541
605400579
605400589

Tischleuchte · Table lamp

↑ 18 cm, Ø 9,5 cm
excl. 1 x E14, max. 25 W



595400101
595400111
595400141
595400179
595400189





GARDA

Nickel matt, Stoffschirm · nickel mat, fabric shade ·
 nickel mat, abat-jour tissu · nikkel mat, Stoffen kap · níquel mate, Pantalla de tela ·
 nichel opaco, paralume in tessuto · nichel mat, abajur textil · harjattu teräs, kangas varjostin ·
 nikiel mat, Klosz z materiału

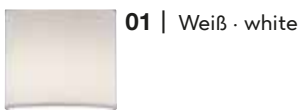

01 | Weiß · white



11 | Grau · grey



41 | Taupe · taupe



79 | goldfarbig · gold



89 | silberfarbig · silver

Pendelleuchte · Pendant
 ↔ 77 x 13,5 cm, ↓ 95 - 150 cm
 excl. 4 x E14, max. 28 W



305400401
 305400411
 305400441
 305400479
 305400489



Stehleuchte · Floor lamp
 ↓ 180 cm, ↔ 35 cm, ↗ 80 cm
 excl. 1 x E27, max. 60 W



407500179



Tischleuchte · Table lamp
 ↓ 50 cm, ↔ 16 cm, ↗ 32 cm
 excl. 1 x E14, max. 40 W



507500179



Pendelleuchte · Pendant
 Ø 35 cm, ↓ 150 cm
 excl. 1 x E27, max. 60 W



307500179



ANDREUS

Metall, Schwarz matt, Stoffschirm · metal, black mat, fabric shade ·
 metale, noir mat, abat-jour tissu · metaal, mat zwart, Stoffen kap ·
 metal, estera negra, Pantalla de tela · metallo, nero opaco,
 paralume in tessuto · metal, negru mat, abajur textil ·
 metalli, mattamusta, kangas varjostin ·
 metal, czarny mat, Klosz z materiału



Wandleuchte · Wall lamp
 Ø 15 cm, ↑ 26,5 cm, ↗ 19,5 cm
 excl. 1 x E14, max. 40 W



207500179 | goldfarbig, Schwarz matt · gold, black mat
 207500189 | silberfarbig, Weiß mat · silver, white mat

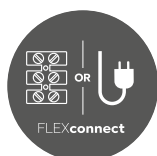



Deckenleuchte · Ceiling lamp

Ø 30 cm, ↑ 22 cm
excl. 2 x E14, max. 40 W



608200279

108



Stehleuchte · Floor lamp

↑ 160,5 cm, Ø 35 cm
excl. 1 x E27, max. 60 W



408200179



Tischleuchte · Table lamp

↑ 33 cm, Ø 20 cm
excl. 1 x E27, max. 40 W



508200179





HOSTEL

Metall, Stoffschild innen goldfarbig · metal, fabric shade gold colored inside ·
 metale, abat-jour tissu Or · metaal, Stoffen kap Binnenkant goudkleur ·
 metal, Pantalla de tela Interior en color dorado · metallo, paralume in tessuto
 interno colore oro · metal, abajur textil interior culoare aurie · metalli, kangas
 varjostin sisäosa kullanvärinen · metal, Klosz z materiału wewnątrz złoty



Pendelleuchte · Pendant
 Ø 40 cm, ↓ 150 cm
 excl. 1 x E27, max. 60 W



308200179



Stehleuchte · Floor lamp
 ↓ max. 156 cm, Ø 35 cm, ↗ max. 63 cm
 excl. 1 x E27, max. 60 W



408290179



Wandleuchte · Wall lamp

↓ 12 x 16 cm, ↗ 21 cm
excl. 1 x GU10, max. 5 W



803670107
803670132



Deckenleuchte · Ceiling lamp

↔ 44 x 16 cm, ↓ 21 cm
excl. 2 x GU10, max. 5 W



803600207
803600232



Deckenleuchte · Ceiling lamp

↔ 66 x 16 cm, ↓ 21 cm
excl. 3 x GU10, max. 5 W



803600307
803600332



07 | Nickel matt · nickel mat



32 | Schwarz matt · black mat



WAILER

Metall, Nickel matt oder Schwarz matt, Stoffschirm ·
 metal, nickel mat or black mat, fabric shade ·
 metale, nickel mat ou noir mat, abat-jour tissu ·
 metaal, nikkell mat of mat zwart, Stoffen kap ·
 metal, níquel mate o estera negra, Pantalla de tela ·
 metallo, nichel opaco o nero opaco, paralume in tessuto ·
 metal, nichel mat sau negru mat, abajur textil ·
 metalli, harjattu teräs tai mattamusta, kangas varjostin ·
 metal, nikiel mat lub czarny mat, Klosz z materiału



Pendelleuchte · Pendant
 Ø 12 cm, ↓ 150 cm
 excl. 1 x GU10, max. 5 W



303600107
 303600132



Pendelleuchte · Pendant
 ↔ 80 x 12 cm, ↓ 150 cm
 excl. 4 x GU10, max. 5 W



303600407
 303600432



Pendelleuchte · Pendant
 Ø 35 cm, ↓ 150 cm
 excl. 3 x GU10, max. 5 W



303690307
 303690332

Empfohlen:
 recommended: LED GU10, 5 W
 400 lm, 3.000 K



956-55



Pendelleuchte · Pendant
 ↓ 150 cm, Ø 10 cm
 excl. 1 x E27, max. 28 W



310600101
 310600132
 310600154



Pendelleuchte · Pendant
 ↓ 150 cm, Ø 37 cm
 excl. 3 x E27, max. 28 W



310630301
 310630332
 310630354



Pendelleuchte · Pendant
 ↓ 150 cm, ↔ 80,5 cm
 excl. 4 x E27, max. 28 W



310600401
 310600432
 310600454



Tischleuchte · Table lamp
 ↓ 25,5 cm, Ø 11 cm
 excl. 1 x E27, max. 28 W



510600101
 510600132
 510600154



ROBIN

Metall, Glas · metal, glass ·
 metale, verre · metaal, glas · metal, vidrio ·
 metallo, vetro · metal, sticla · metalli, lasi · metal, szkło

01 | Schwarz matt, Glas weiß · black mat, glass white

32 | Schwarz matt, Glas rauchfarbig · black mat, glass smoke

54 | Messing matt, Glas rauchfarbig · brass mat, glass smoke





Wandleuchte · Wall lamp
 † 20,6 cm, † 21,3 cm
 excl. 1 x E14, max. 28 W



202000108
 202000132
 202000142

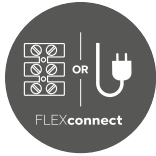

Seite/page 648



Tischleuchte · Table lamp
 † 52 cm, † 18 cm, † 24,2 cm
 excl. 1 x E14, max. 28 W



502000108
 502000132
 502000142



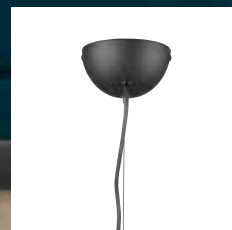

PURE

Metall, Glas · metal, glass ·
metale, verre · metaal, glas · metal, vidrio ·
metallo, vetro · metal, sticla · metalli, lasi · metal, szkło



08 | Messing matt, Glas Weiß ·
brass mat, glass white



32 | Schwarz matt, Glas Weiß ·
black mat, glass white



42 | Anthazit, Rauchglas ·
anthracite, smoked glass



Pendelleuchte · Pendant
↓ 150 cm, Ø 40 cm
excl. 3 x E14, max. 28 W



302000308
302000332
302000342



Stehleuchte · Floor lamp
↓ 150 cm, ↔ 25 cm, ↗ 31,7 cm
excl. 1 x E14, max. 28 W



402000108
402000132
402000142



Pendelleuchte · Pendant
 ↔ 100 x 16 cm, ↓ 150 cm
 excl. 5 x E14, max. 28 W



308500531
 308500542

Empfohlen:
 recommended: Filament LED E14, 4 W
 470 lm, 3.000 K



983-400



BALINI

Metall, Glas klar oder Rauchglas · metal, clear glass or smoked glass ·
 metale, verre claire ou verre fumé · metaal, helder glas of rookglas ·
 metal, vidrio claro o vidrio ahumado · metallo, vetro chiaro o vetro fume' ·
 metal, sticlă transparentă sau sticlă fumurie · metalli, kirkas lasi tai savulasi ·
 metal, przezroczyste szkło lub szkło przydymione



31 | Weiß matt, Glas klar ·
white mat, clear glass



42 | Anthrazit, Rauchglas ·
anthracite, smoked glass



Pendelleuchte · Pendant
 Ø 30 cm, ↓ 150 cm
 excl. 3 x E14, max. 28 W



308590331
308590342



Stehleuchte · Floor lamp
 ↓ 180 cm, ↔ 30 cm, ↗ 85 cm
 excl. 5 x E14, max. 28 W



408500531
408500542



ALICIA

Chrom, Glas rauchfarbig · chrome, glass smoke ·
 chrome, verre fumé · chroom, glas rookkleur ·
 cromo, vidrio humo · cromo, vetro fume' ·
 crom, sticla fumuriu · kromi, lasi savu ·
 chrom, szkło przydymiony



Stehleuchte · Floor lamp
 ↓ 155 cm, Ø 25 cm
 excl. 9 x G9, max. 5 W



407690906



Tischleuchte · Table lamp
 ↓ 52 cm, Ø 23 cm
 excl. 6 x G9, max. 5 W



507690606



Pendelleuchte · Pendant
 ↓ 150 cm, Ø 45 cm
 excl. 12 x G9, max. 10 W



307601206

Empfohlen:
 recommended: LED G9, 3 W
 300 lm, 3.000 K



929-2300





ALICIA

Chrom, Glas rauchfarbig · chrome, glass smoke ·
 chrome, verre fumé · chroom, glas rookkleur ·
 cromo, vidrio humo · cromo, vetro fume' ·
 crom, sticla fumuriu · kromi, lasi savu ·
 chrom, szkło przydymiony



Deckenleuchte · Ceiling lamp
 ↔ 100 x 24,5 cm, ↓ 22,5 cm
 excl. 10 x G9, max. 10 W



607601006

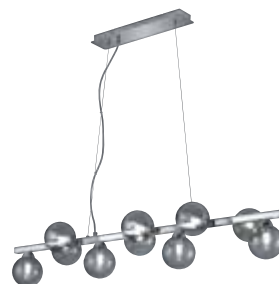

Pendelleuchte · Pendant
 ↓ 150 cm, ↔ 100 x 24,5 cm
 excl. 10 x G9, max. 10 W



307601006



Deckenleuchte · Ceiling lamp
 Ø 45 cm, ↓ 46,5 cm
 excl. 12 x G9, max. 10 W



607601206

Empfohlen:

recommended: LED G9, 3 W
 300 lm, 3.000 K



929-2300

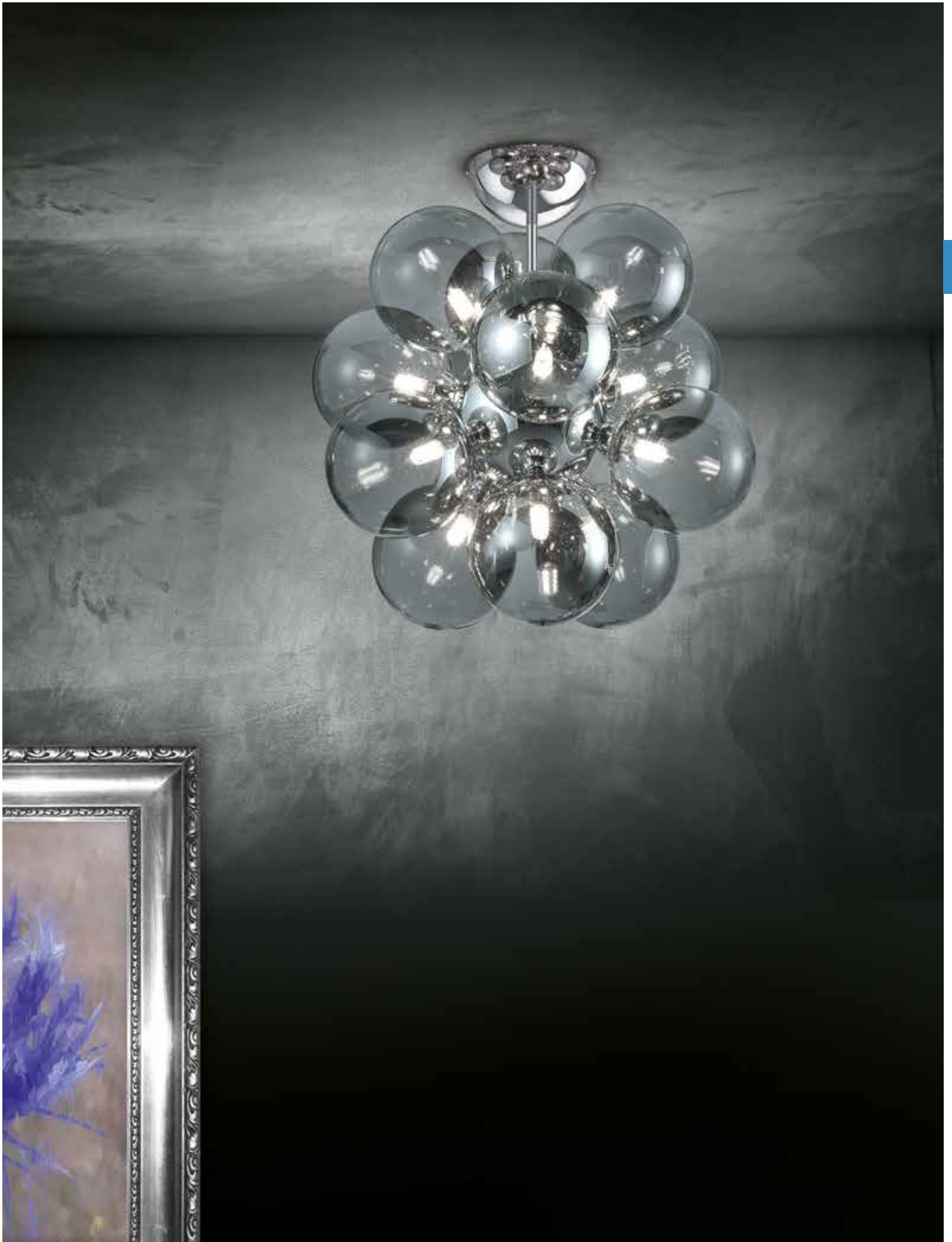



Deckenleuchte · Ceiling lamp
 Ø 40 cm, ↓ 22 cm
 excl. 5 x G9, max. 42 W



611210506



Pendelleuchte · Pendant
 Ø 50 cm, ↓ 150 cm
 excl. 6 x G9, max. 42 W



311210606



Tischleuchte · Table lamp
 Ø 28 cm, ↓ 43 cm
 excl. 3 x G9, max. 42 W



511210306





VAPORE

Chrom, Glas chrom bedampft · chrome, chroom plated glass ·
 chrome, verre plaqué chrome · chroom, chroom opgedampt glas ·
 cromo, vidrio cromado · cromo, vetro verniciato cromo ·
 crom, sticla cromata · kromi, kromipäällystetty lasi ·
 chrom, szkło chromowane

Empfohlen:
 recommended: LED G9, 3 W
 300 lm, 3.000 K



929-2300



Pendelleuchte · Pendant
 Ø 40 cm, †150 cm
 excl. 5 x G9, max. 42 W



311210506



Stehleuchte · Floor lamp
 Ø 40 cm, †158 cm
 excl. 4 x G9, max. 42 W



411210406



Deckenleuchte · Ceiling lamp

Ø 40 cm, ↑ 17,5 cm
excl. 2 x E27, max. 40 W



606100232



Deckenleuchte · Ceiling lamp

Ø 50 cm, ↑ 21 cm
excl. 3 x E27, max. 40 W



606100332



Tischleuchte · Table lamp

Ø 30 cm
excl. 1 x E14, max. 40 W



506100132



Tischleuchte · Table lamp

Ø 50 cm
excl. 1 x E27, max. 60 W



506190132

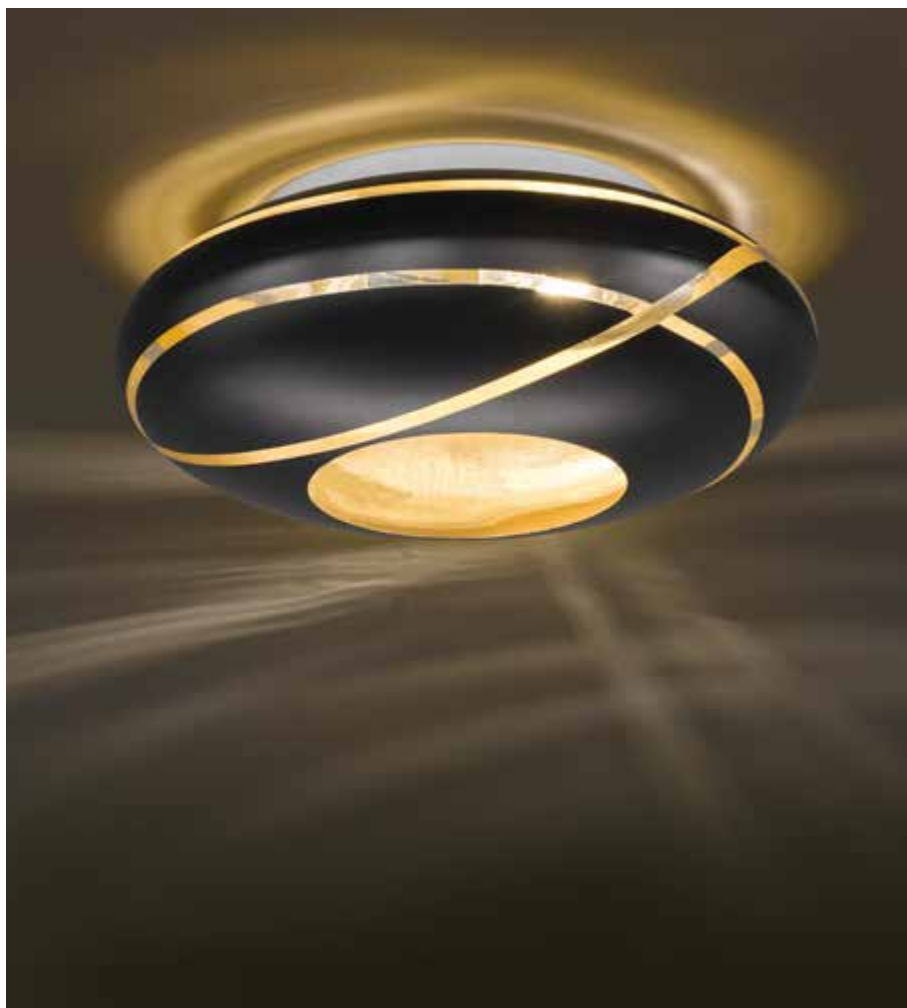



FARO

Chrom, Glas Schwarz matt, innen goldfarbig · chrome, glass black mat, gold colored inside ·
 chrome, verre noir mat, Or · chroom, glas mat zwart, Binnenkant goudkleur ·
 cromo, vidrio estera negra, Interior en color dorado · cromo, vetro nero opaco,
 interno colore oro · crom, sticla negru mat, interior culoare aurie · kromi, lasi
 musta matto, sisäosa kullanvärinen · chrom, szkło czarny mat, wewnątrz złoty ·
 krom, cam siyah mat, altın iç kaplama



Pendelleuchte · Pendant
 Ø 30 cm, ↓ 150 cm
 excl. 1 x E27, max. 40 W



306100132



Pendelleuchte · Pendant
 Ø 50 cm, ↓ 150 cm
 excl. 1 x E27, max. 60 W



306190132



Pendelleuchte · Pendant

↓ 155 cm, Ø 33 cm
excl. 1 x E27, max. 60 W



305200179 | Glas goldfarbig · glass gold

126



Pendelleuchte · Pendant

↓ 150 cm, Ø 18 cm
excl. 1 x E14, max. 40 W



305290179 | Glas goldfarbig · glass gold



Pendelleuchte · Pendant

↔ 80 x 18 cm, ↓ 150 cm
excl. 3 x E14, max. 40 W



305200379 | Glas goldfarbig · glass gold





ONTARIO

Glas goldfarbig, silberfarbig oder kupferfarbig · glass gold, silver or copper ·
 verre or, argent ou cuivré · glas goud, zilver of koperkleurig · vidrio oro, plata o color cobre ·
 vetro oro, argento o colore rame · sticla aur, argint sau cupru · lasi kultaa, hopea tai kuperinvärinen ·
 szkło złota, srebrny lub kolorze miedzi



09 | kupferfarbig · copper



79 | goldfarbig · gold



89 | silberfarbig · silver

Pendelleuchte · Pendant
 ↓ 155 cm, Ø 51 cm
 excl. 1 x E27, max. 60 W



315200109
 315200179
 315200189



VALENTE

Metall, Glas · metal, glass ·
 metale, verre · metaal, glas · metal, vidrio ·
 metallo, vetro · metal, sticla · metalli, lasi · metal, szkło



31 | Weiß matt, Glas klar · white mat, clear glass



42 | Anthrazit, Rauchglas · anthracite smoked glass



Deckenleuchte · Ceiling lamp
 Ø 40 cm, ↓ 25 cm
 excl. 3 x E27, max. 60 W



600600331
 600600342



Pendelleuchte · Pendant
 Ø 40 cm, ↓ 150 cm
 excl. 3 x E27, max. 60 W



300600331
 300600342

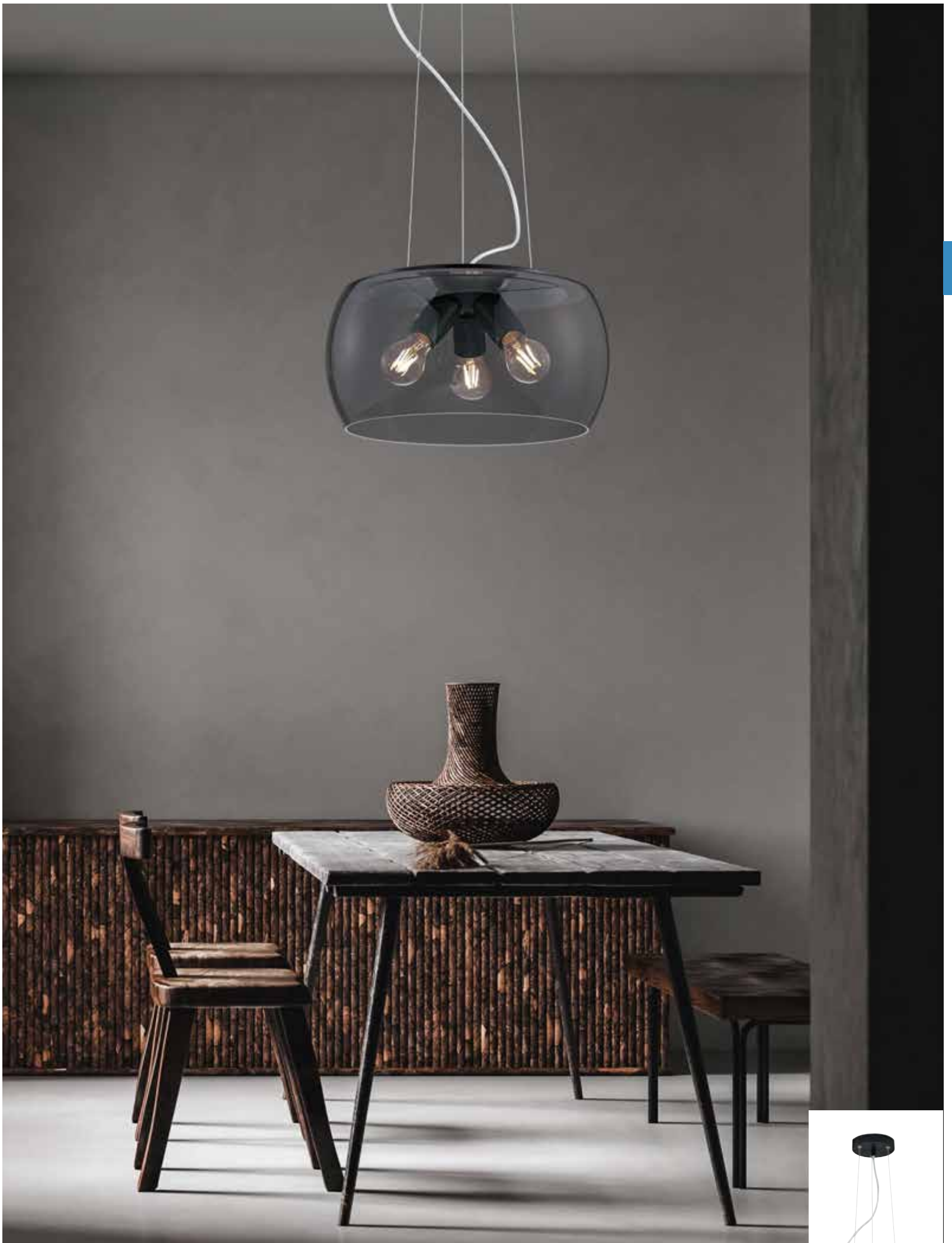

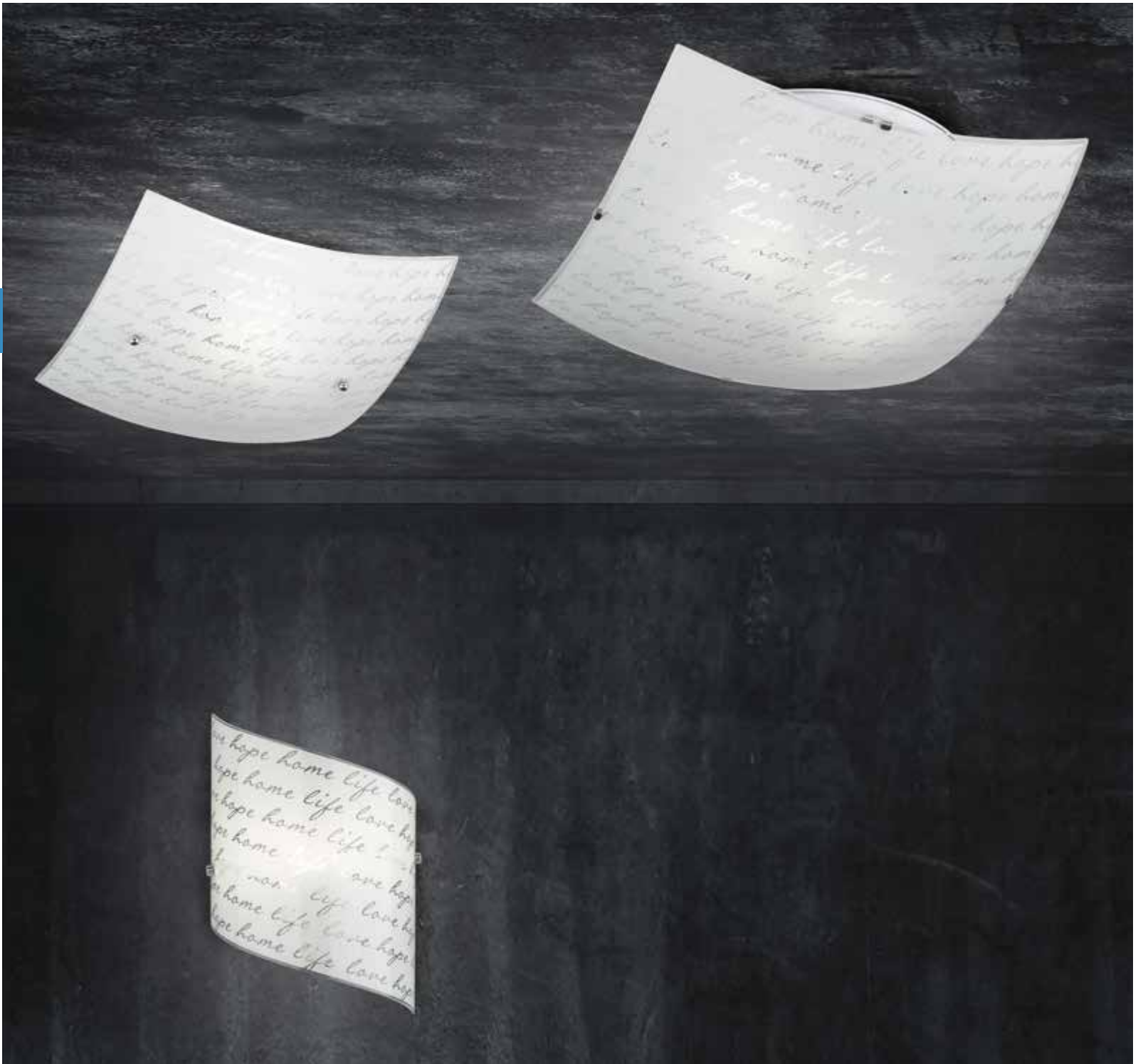

Wandleuchte · Wall lamp
 ↔ 20 x 30 cm, ↗ 9 cm
 excl. 1 x E27, max. 40 W



202500101



Deckenleuchte · Ceiling lamp
 ↔ 30 x 30 cm, ↓ 9 cm
 excl. 1 x E27, max. 40 W



602500101



Deckenleuchte · Ceiling lamp
 ↔ 40 x 40 cm, ↓ 9,5 cm
 excl. 2 x E27, max. 40 W



602500201



SIGNA

Chrom, Dekorglas Weiß · chrome, glas decorated white ·
 chrome, verre décoré blanc · chroom, decoratief glas wit ·
 cromo, vidrio decorado blanco · cromo, vetro decorato bianco ·
 crom, sticla decorativa alb · kromi, ornamenttilasi valkoinen ·
 chrom, szkło dekoracyjne biały

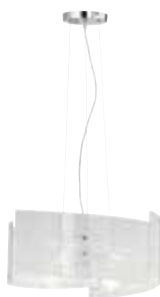

Pendelleuchte · Pendant
 Ø 50 cm, ↓ 150 cm
 excl. 3 x E27, max. 40 W



302500301





SANDRINA

Dekorglas · glas decorated ·
verre décoré · decoratief glas · vidrio decorado ·
vetro decorato · sticla decorativa · ornamenttilasi · szkło dekoracyjne



Wandleuchte · Wall lamp
↔ 30 x 15 cm, ↗ 8 cm
excl. 1 x E27, max. 40 W



201200100



Deckenleuchte · Ceiling lamp
Ø 30 cm, ↓ 9 cm
excl. 1 x E27, max. 40 W



601200100



Deckenleuchte · Ceiling lamp
Ø 40 cm, ↓ 10 cm
excl. 2 x E27, max. 40 W



601200200



Pendelleuchte · Pendant
Ø 50 cm, ↓ 150 cm
excl. 3 x E27, max. 40 W



301200300





Deckenleuchte · Ceiling lamp
↔ 30 x 30 cm, ↓ 9 cm
excl. 1 x E27, max. 40 W



604400101



Deckenleuchte · Ceiling lamp
↔ 40 x 40 cm, ↓ 9,5 cm
excl. 2 x E27, max. 40 W



604400201



Deckenleuchte · Ceiling lamp
↔ 50 x 50 cm, ↓ 11 cm
excl. 3 x E27, max. 40 W



604400301

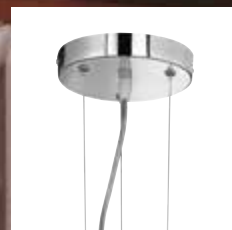

SPIRELLI

Chrom, Dekorglas Weiß · chrome, glas decorated white ·
 chrome, verre décoré blanc · chrom, decoratief glas wit · cromo, vidrio decorado blanco ·
 cromo, vetro decorato bianco · crom, sticla decorativa alb · kromi, ornamentilasi valkoinen ·
 chrom, szkło dekoracyjne biały



Wandleuchte · Wall lamp
 ↔ 30 x 22 cm, ∅ 7,5 cm
 excl. 1 x E27, max. 40 W



204400101



Pendelleuchte · Pendant
 ↔ 40 x 20 cm, ↓ 150 cm
 excl. 2 x E27, max. 40 W



304400201



Wandleuchte · Wall lamp

↔ 30 x 22 cm, ↕ 7,5 cm
excl. 1 x E27, max. 40 W



208700179

208700189

79 | goldfarbig · gold



89 | silberfarbig · silver



Deckenleuchte · Ceiling lamp

↔ 30 x 30 cm, ↕ 9 cm
excl. 1 x E27, max. 40 W



608700179

608700189



Deckenleuchte · Ceiling lamp

↔ 40 x 40 cm, ↕ 9,5 cm
excl. 2 x E27, max. 40 W



608700279

608700289

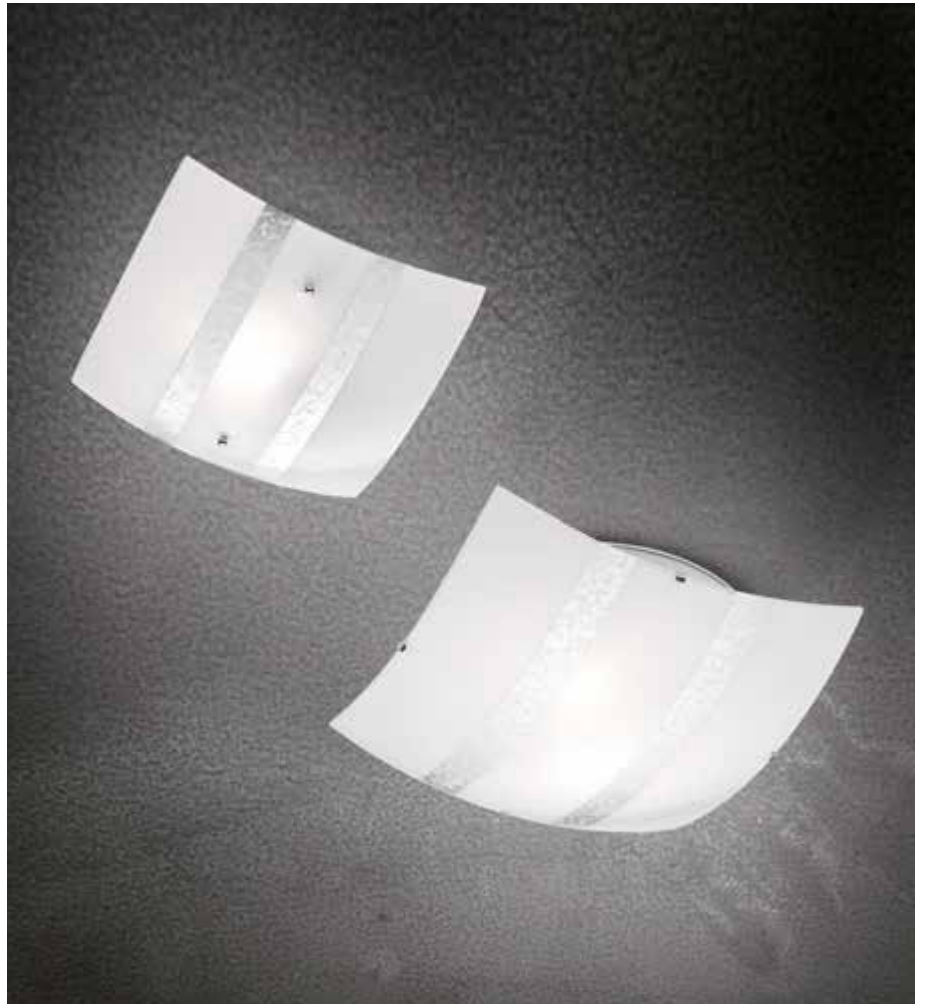



NIKOSIA

Dekorglas · glas decorated ·
verre décoré · decoratief glas ·
vidrio decorado · vetro decorato ·
sticla decorativa · ornamenttilasi ·
szkło dekoracyjne



Pendelleuchte · Pendant
Ø 14 cm, ↓ 150 cm
excl. 1 x E27, max. 40 W



308700179
308700189



Pendelleuchte · Pendant
↔ 50 x 20 cm, ↓ 150 cm
excl. 2 x E27, max. 40 W



308700279
308700289



SWEETY

Acryl · acryl ·
acryl · acryl · acrílico · acrílico ·
acrilic · akryyli · akryl



Wandleuchte · Wall lamp
↔ 20 x 20 cm, ↗ 9 cm
excl. 1 x E14, max. 40 W



207800100



Deckenleuchte · Ceiling lamp
Ø 30 cm, ↑ 10,5 cm
excl. 1 x E27, max. 60 W



607800100



Pendelleuchte · Pendant
Ø 30 cm, ↑ 150 cm
excl. 1 x E27, max. 60 W



307800100



Pendelleuchte · Pendant
Ø 40 cm, ↑ 150 cm
excl. 1 x E27, max. 60 W



307804100





FILO

Metall Schwarz matt, Glas Weiß · metal black mat, glass white ·
 metale noir mat, verre blanc · metaal mat zwart, glas wit · metal estera negra, vidrio blanco ·
 metallo nero opaco, vetro bianco · metal negru mat, sticla alb · metalli mattamusta, lasi valkoinen ·
 metal czarny mat, szkło biały



Pendelleuchte · Pendant
 ↓ 150 cm, Ø 40 cm
 excl. 1 x E27, max. 60 W



313900132



Pendelleuchte · Pendant
 ↔ 100 x 40 cm, ↓ 150 cm
 excl. 2 x E27, max. 60 W



313900232



Stehleuchte · Floor lamp
 ↓ 150 cm, ↔ 57,5 cm, Ø 40 cm
 excl. 1 x E27, max. 60 W



413900132







Deckenleuchte · Ceiling lamp
 Ø 40 cm, ↑ 15 cm
 excl. 3 x E27, max. 25 W



603500331
 603500332



31 | Weiß matt · white mat



32 | Schwarz matt · black mat



Wandleuchte · Wall lamp
 ↔ 40 x 13 cm, ∇ 6,5
 incl. 1 x SMD-LED, 13 W
 1.000 lm, 3.000 K

223510231
 223510232



Wandleuchte · Wall lamp
 ↔ 18 x 13 cm, ∇ 6 cm
 incl. 1 x SMD-LED, 6,5 W
 500 lm, 3.000 K

223510131
 223510132

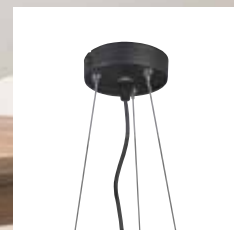

ZANDOR

Metall, Weiß matt oder Schwarz matt, Acryl · metal, white mat or black mat, acryl ·
 metale, blanc mat ou noir mat, acryl · metaal, wit mat of mat zwart, acryl ·
 metal, estera blanca o estera negra, acrílico · metallo, bianco opaco o nero opaco, acrilico ·
 metal, alb mat sau negru mat, acrilic · metalli, mattavalkoinen tai mattamusta, akryyli ·
 metal, biały mat lub czarny mat, akryl

Pendelleuchte · Pendant
 Ø 50 cm, ↑ 150 cm
 excl. 3 x E27, max. 25 W



303500331
 303500332





31 | Weiß matt · white mat



42 | Anthrazit · anthracite



Pendelleuchte · Pendant
 ↓ 150 cm, Ø 25 cm
 excl. 2 x E14, max. 15 W



308900231
 308900242



Pendelleuchte · Pendant
 ↓ 150 cm, Ø 45 cm
 excl. 3 x E27, max. 15 W



308900331
 308900342



Pendelleuchte · Pendant
 ↔ 105 cm, ↓ 150 cm, Ø 25 cm
 excl. 6 x E14, max. 15 W



308900631
 308900642



Deckenleuchte · Ceiling lamp
 Ø 45 cm, ↓ 23 cm
 excl. 3 x E27, max. 15 W



608900331
 608900342



BARONESS

Metall, Weiß matt oder Anthrazit, Acryl weiß · metal, white mat or anthracite, acryl white ·
 metale, blanc mat ou antracite, acryl blanc · metaal, wit mat of antraciet, acryl wit ·
 metal, estera blanca o antracita, acrílico blanco · metallo, bianco opaco o antracite,
 acrilico bianco · metal, alb mat sau antracit, acrilic alb · metalli, mattavalkoinen tai
 antrasiitti, akryyli valkoinen · metal, biały mat lub antracyt, akryl biały



Tischleuchte · Table lamp
 ↑ 45 cm, Ø 25 cm
 excl. 2 x E14, max. 15 W



508900231
 508900242



Stehleuchte · Floor lamp
 ↑ 150 cm, Ø 45 cm
 excl. 3 x E27, max. 15 W



408900331
 408900342



BARON

Metall, Weiß matt oder Schwarz matt, Acryl · metal, white mat or black mat, acryl ·
 metale, blanc mat ou noir mat, acryl · metaal, wit mat of mat zwart, acryl ·
 metal, estera blanca o estera negra, acrílico · metallo, bianco opaco o nero opaco, acrilico ·
 metal, alb mat sau negru mat, acrilic · metalli, mattavalkoinen tai mattamusta, akryyli ·
 metal, biały mat lub czarny mat, akryl



Deckenleuchte · Ceiling lamp
 Ø 52 cm, ↓ 24 cm
 excl. 4 x E27, max. 40 W



609800431
 609800432



Pendelleuchte · Pendant
 Ø 52 cm, ↓ 150 cm
 excl. 4 x E27, max. 40 W



309800431
 309800432



31 | Weiß matt · white mat



32 | Schwarz matt · black mat





CONNOR

Metall, Weiß matt oder Schwarz matt · metal, white mat or black mat ·
 metale, blanc mat ou noir mat · metaal, wit mat of mat zwart ·
 metal, estera blanca o estera negra · metallo, bianco opaco o nero opaco ·
 metal, alb mat sau negru mat · metalli, valkoinen matto tai musta matto ·
 metal, biały mat lub czarny mat

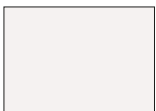

31 | Weiß matt · white mat



32 | Schwarz matt · black mat

Empfohlen:
 recommended: Filament LED E27, 6 W
 600 lm, 3.000 K



988-600



Stehleuchte · Floor lamp
 ↓ 138 cm, ↔ 43 cm
 excl. 5 x E27, max. 10 W



406200532



Pendelleuchte · Pendant
 ↔ 126 x 40 cm, ↓ 150 cm
 excl. 8 x E27, max. 10 W



306200831
 306200832

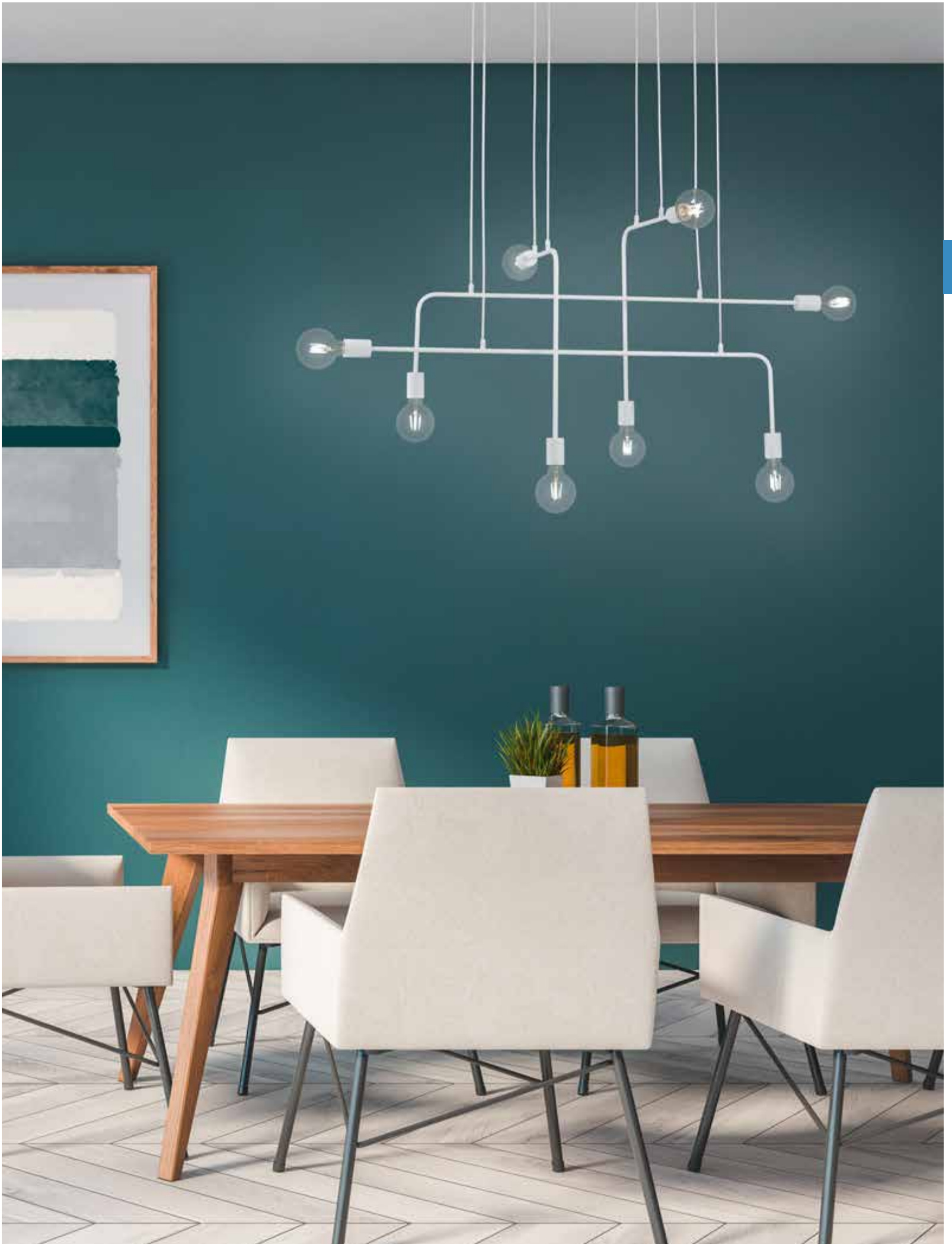

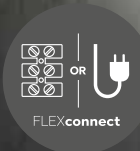

Seite/page 648



Wandleuchte · Wall lamp
 ↑ 15 x 10 cm, ↗ 20 cm
 excl. 1 x E27, max. 42 W



208070131
208070132



Deckenleuchte · Ceiling lamp
 Ø 47 cm, ↑ 16,5 cm
 excl. 3 x E27, max. 42 W



608000331
608000332

Empfohlen:
 recommended: Filament LED E27, 6 W
 250 lm, 3.000 K



988-654

Filament LED E27, 6 W
 420 lm, 2.700 K



988-679





DIALLO

Metall, Weiß matt oder Schwarz matt · metal, white mat or black mat ·
 metale, blanc mat ou noir mat · metaal, wit mat of mat zwart ·
 metal, estera blanca o estera negra · metallo, bianco opaco o nero opaco ·
 metal, alb mat sau negru mat · metalli, valkoinen matto tai musta matto ·
 metal, biały mat lub czarny mat

31 | Weiß matt · white mat

32 | Schwarz matt · black mat



Tischleuchte · Table lamp
 ↑ 51 cm, ↔ 15 cm, ↗ 23,5 cm
 excl. 1 x E27, max. 42 W



508000131
 508000132



Stehleuchte · Floor lamp
 ↑ 149 cm, ↔ 23 cm, ↗ 39,3 cm
 excl. 1 x E27, max. 42 W



408000131
 408000132



Pendelleuchte · Pendant
 Ø 25 cm, ↓ 150 cm
 excl. 3 x E27, max. 40 W



309230332



Pendelleuchte · Pendant
 ↔ 80 x 15 cm, ↓ 150 cm
 excl. 4 x E27, max. 40 W



309200432



Pendelleuchte · Pendant
 Ø 15 cm, ↓ 150 cm
 excl. 1 x E27, max. 40 W



309200132





JAMIRO

Metall, Schwarz matt, Beton · metal, black mat, concrete ·
 metale, noir mat, béton · metaal, mat zwart, beton ·
 metal, estera negra, hormigón · metallo, nero opaco, cemento ·
 metal, negru mat, beton · metalli, mattamusta, betoni ·
 metal, czarny mat, beton

Empfohlen:
 recommended: Filament LED E27, 4,5 W
 470 lm, 2.700 K



987-400



Tischleuchte · Table lamp
 ↓ 24 cm, Ø 15 cm
 excl. 1 x E27, max. 40 W



509200132



BELA

Metall, Schwarz matt / goldfarbig · metal, black mat / gold ·
 metale, noir mat / or · metaal, mat zwart / goud ·
 metal, estera negra / oro · metallo, nero opaco / oro ·
 metal, negru mat / aur · metalli, musta matto / kultaa ·
 metal, czarny mat / złota

Empfohlen:
 recommended: Filament LED E27, 8 W
 700 lm, 2.700 K



987-6700



Stehleuchte · Floor lamp
 ↓ 140,5 cm, ↔ 23 x 16 cm
 excl. 3 x E27, max. 10 W



407900332

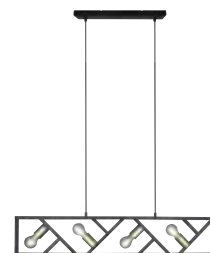

Pendelleuchte · Pendant
 ↔ 105 x 8,5 cm, ↓ 150 cm
 excl. 4 x E27, max. 10 W



307900432



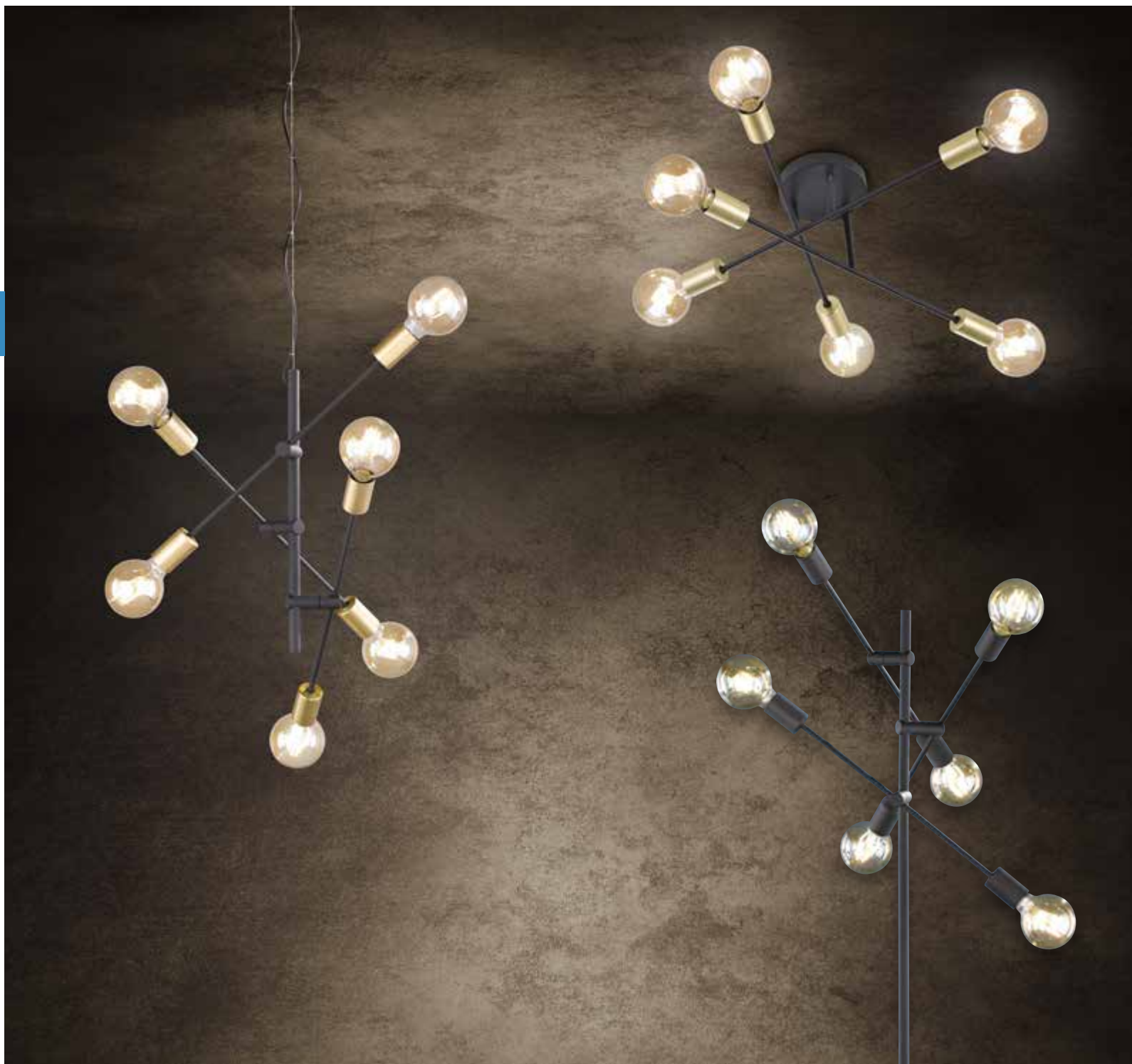

Pendelleuchte · Pendant
 Ø 54,5 cm, ↑ 150 cm
 excl. 6 x E27, max. 28 W



306700632
306700602 | Schwarz · black

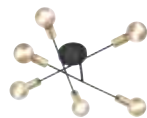

Deckenleuchte · Ceiling lamp
 Ø 56,6 cm, ↑ 19,1 cm
 excl. 6 x E27, max. 40 W



606700632



Stehleuchte · Floor lamp
 ↑ 165 cm, Ø 54,5 cm
 excl. 6 x E27, max. 28 W



406700632
406700602 | Schwarz · black





CROSS

Metall, Schwarz matt / goldfarbig · metal, black mat / gold ·
 metale, noir mat / or · metaal, mat zwart / goud ·
 metal, estera negra / oro · metallo, nero opaco / oro ·
 metal, negru mat / aur · metalli, musta matto / kultaa ·
 metal, czarny mat / złota

Empfohlen:
 recommended: Filament LED E27, 6 W
 420 lm, 2.700 K



988-679



Pendelleuchte · Pendant
 ↔ 91 x 45 cm, ↓ 150 cm
 excl. 7 x E27, max. 28 W



306700732

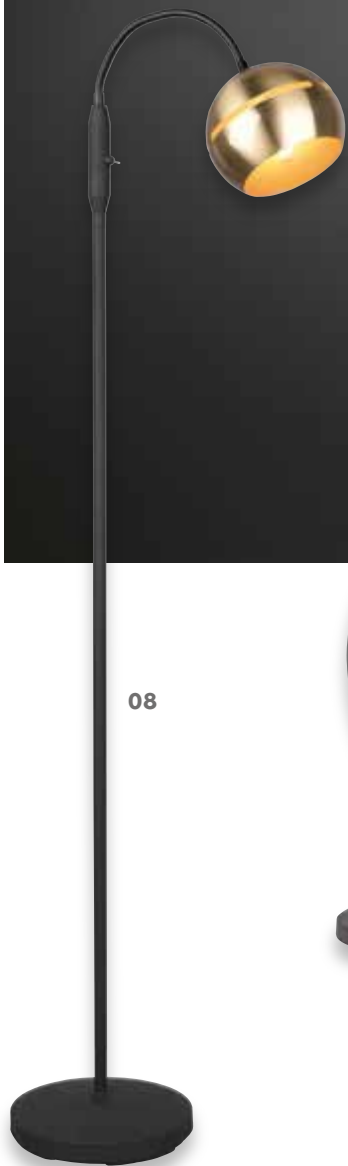

08



07



32



4 fach TOUCH ·
4 level Touch function

- 07 | Nickel matt · nickel mat
- 08 | Messing matt / Schwarz matt · brass mat / black mat
- 32 | Schwarz matt · black mat



FLETCHER

Metall · metal ·
metale · metaal · metal ·
metallo · metal · metalli · metal



Tischleuchte · Table lamp
↑ 42,5 cm, ↔ 15 cm, ↗ 31 cm
excl. 1 x E14, max. 10 W



593300107
593300108
593300132



Stehleuchte · Floor lamp
↑ 143 cm, ↔ 23 cm, ↗ 42 cm
excl. 1 x E14, max. 10 W



413300107
413300108
413300132



Pendelleuchte · Pendant
↔ 75 x 15 cm, ↓ 150 cm
excl. 3 x E14, max. 40 W



313300307
313300308
313300332



Pendelleuchte · Pendant
↔ 105 x 15 cm, ↓ 150 cm
excl. 4 x E14, max. 40 W



313300407
313300408
313300432



Tischleuchte · Table lamp
 ↓ 45 cm, ↔ 15 cm, ↗ 23 cm
 excl. 1 x E14, max. 18 W



- 500500104
- 500500107
- 500500109



Stehleuchte · Floor lamp
 ↓ 140 cm, ↔ 23 cm, ↗ 52 cm
 excl. 1 x E14, max. 18 W



- 400500104
- 400500107
- 400500109





JASPER

Metall · metal ·
metale · metaal · metal · metallo ·
metal · metalli · metal · metal



04 | Altmessing · old brass



07 | Nickel matt · matt nickel



09 | kupferfarbig · copper



Pendelleuchte · Pendant
Ø 31 cm, ↓ 150 cm
excl. 1 x E27, max. 60 W



300500104
300500107
300500109



DISCALGO

Metall, Kunststoff · metal, plastic ·
 metale, plastique · metaal, kunststof · metal, plástico ·
 metallo, plastica · metal, plastic · metalli, muovi · metal, plastik



31 | Weiß matt · white mat



32 | Schwarz matt · black mat



Deckenleuchte · Ceiling lamp
 Ø 54 cm, ↓ 30 cm
 excl. 3 x E14, max. 40 W



609900331
 609900332



Pendelleuchte · Pendant
 Ø 54 cm, ↓ 150 cm
 excl. 6 x E14, max. 40 W



309900631
 309900632



ORCHESTRA

Metall, Schwarz matt / goldfarbig · metal, black mat / gold ·
 metale, noir mat / or · metaal, mat zwart / goud · metal, estera negra / oro ·
 metallo, nero opaco / oro · metal, negru mat / aur · metalli, mattamusta / kultaa ·
 metal, czarny mat / złota

Empfohlen:
 recommended: Filament LED E14, 4 W
 470 lm, 3.000 K



983-400



Deckenleuchte · Ceiling lamp
 Ø 50 cm, ↓ 26 cm
 excl. 10 x E14, max. 28 W



603201032



Pendelleuchte · Pendant
 Ø 48 cm, ↓ 150 cm
 excl. 15 x E14, max. 28 W



303201532



NAPOLI

Metall, rostfarbig antik mit Acrylapplikationen ·
 metal, antique rust with acrylic decoration ·
 métal, rouille antique avec décoration acrylique ·
 Metaal, roestkleur antiek met acryl decoraties ·
 Metal, oxido con decoración en acrílico ·
 metallo, ruggine anticato con decorazione in acrilico ·
 metal, ruginiu antic cu decoratie acrilica ·
 metaalia, rustiikki jossa akryyli koristeet ·
 Metal, antyczny rdzawy z aplikacjami akrylowym

Empfohlen:
 recommended: Filament LED E14, 4,5 W
 470 lm, 2.700 K



989-400



Deckenleuchte · Ceiling lamp
 Ø 50 cm, ↓ 50 cm
 excl. 4 x E14, max. 28 W



610300428



Pendelleuchte · Pendant
 Ø 52 cm, ↓ 150 cm
 excl. 4 x E14, max. 28 W



110300428

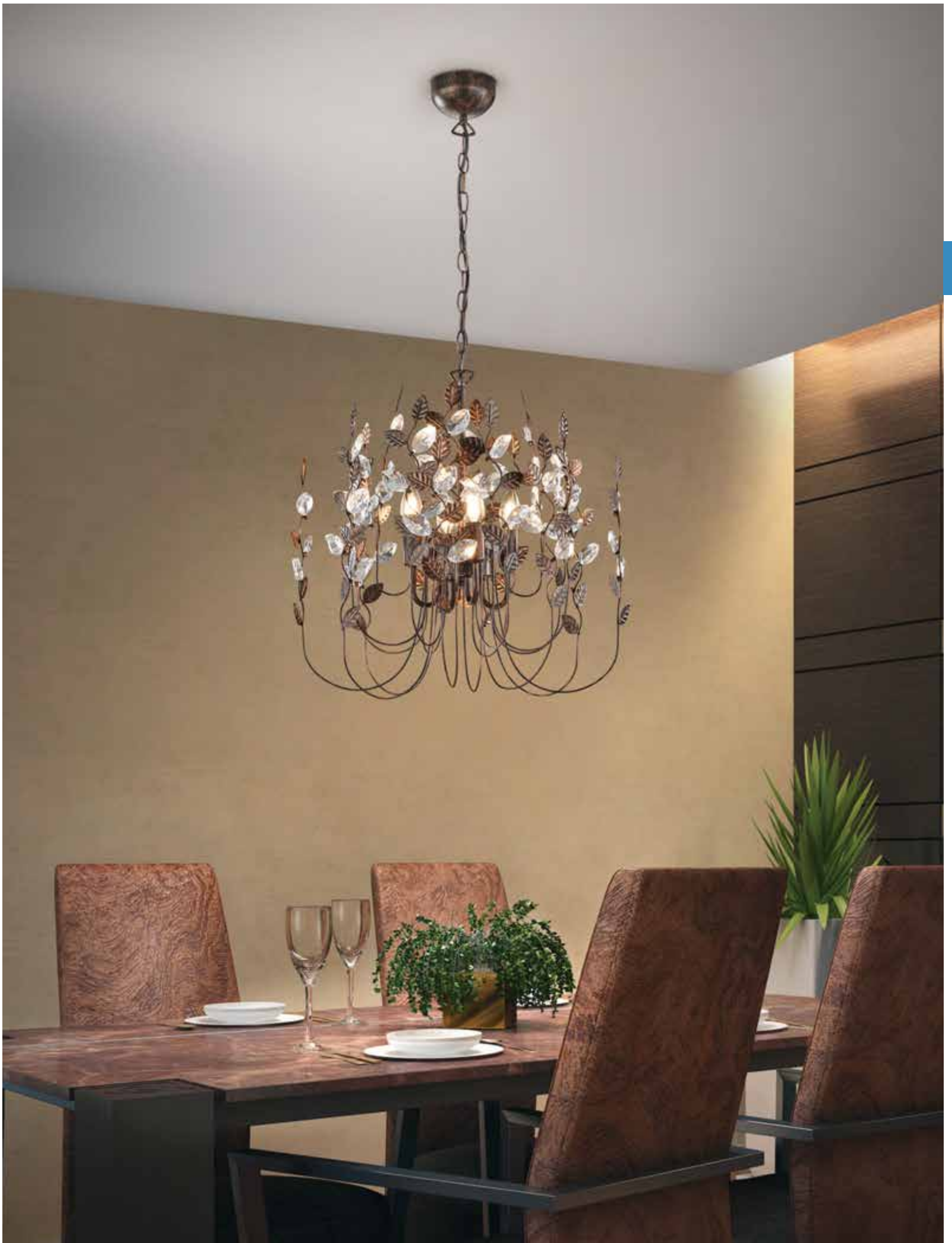



RUSTICA

Metall, rostfarbig, Glas matt · metal, rusty, mat glass ·
 metale, rouille, verre mat · metaal, roestkleur, mat glas ·
 metal, óxido, vidrio mate · metallo, ruggine, vetro sabbaiato ·
 metal, ruginiu, sticla mata · metalli, rustiikki, mattalasi ·
 metal, miedź, szkło matowane



Deckenleuchte · Ceiling lamp
 Ø 55 cm, ↓ 42,5 cm
 excl. 3 x E27, max. 40 W



601000324



Pendelleuchte · Pendant
 ↓ 150 cm, Ø 55 cm
 excl. 3 x E27, max. 40 W



101000324



Pendelleuchte · Pendant
 ↓ 150 cm, Ø 60 cm
 excl. 5 x E27, max. 40 W



101000524





RUSTICA

Metall, rostfarbig, Glas matt · metal, rusty, mat glass ·
 metale, rouille, verre mat · metaal, roestkleur, mat glas ·
 metal, óxido, vidrio mate · metallo, ruggine, vetro sabbaiato ·
 metal, ruginiu, sticla mata · metalli, rustiikki, mattalasi ·
 metal, miedź, szkło matowane



Deckenleuchte · Ceiling lamp
 Ø 38 cm, ↑ 16,5 cm
 excl. 2 x E27, max. 60 W



6102021-24



Tischleuchte · Table lamp
 ↑ 50 cm, Ø 31 cm
 excl. 2 x E14, max. 40 W



501000224



Stehleuchte · Floor lamp
 ↑ 180 cm, Ø 33,5 cm
 excl. 2 x E27, max. 60 W



401000224



Stehleuchte · Floor lamp
 ↑ 180 cm, Ø 32,5 cm
 excl. 1 x E27, max. 100 W
 excl. 1 x E14, max. 40 W



4602021-24





Pendelleuchte · Pendant
 Ø 70 cm, † 150 cm
 excl. 3 x E14, max. 40 W



110700328



Pendelleuchte · Pendant
 Ø 70 cm, † 150 cm
 excl. 5 x E14, max. 40 W



110700528



Deckenleuchte · Ceiling lamp
 Ø 61 cm, † 26 cm
 excl. 3 x E14, max. 40 W



600700328





TRADITIO

Metall, Glas alabasterfarbig · metal, alabaster-coloured glass ·
 metale, verre couleur albâtre · metaal, albastkleurig glas ·
 metal, vidrio de color alabastro · metallo, vetro colore alabastro ·
 metal, sticla culoare alabastru · metalli, lasi alabasteri väri ·
 metal, szkło alabaster kolor

Empfohlen:
 recommended: LED E14, 4 W
 320 lm, 3.000 K



983-40



Wandleuchte · Wall lamp
 ↔ 12 x 21,5 cm, ∅ 29 cm
 excl. 1 x E14, max. 40 W



200700128



Tischleuchte · Table lamp
 ↓ 32 x 16 cm, ∅ 27 cm
 excl. 1 x E14, max. 40 W



500700128

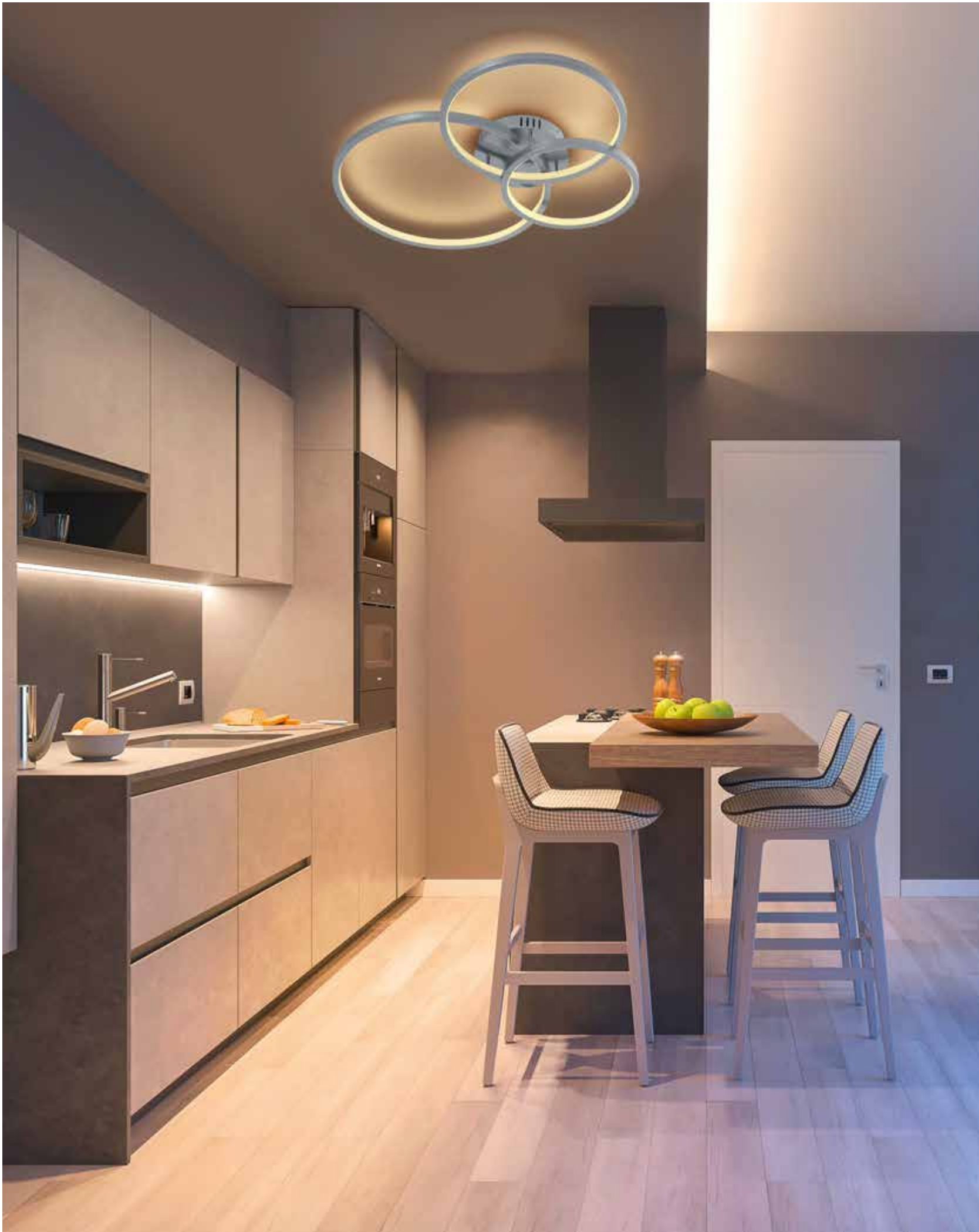

172 - 195

Intelligente Lichtsteuerung

Intelligent light control

Commande intelligente de l'éclairage

Intelligente lichtregeling

Control inteligente de la luz

Controllo della luce intelligente

Comandă inteligentă a luminii

Älykäs valaistuksen ohjaus

Intelligentna kontrola światła



Get your light connected.

TRIO Leuchten mit WiZ-Technologie ermöglichen ein faszinierendes und innovatives Lichtdesign, das sich vollkommen individuell steuern, programmieren und kontrollieren lässt.

Die smarte Lichtsteuerung liefert dabei unbegrenzte Möglichkeiten für jeden Anlass die gewünschte Atmosphäre zu kreieren - ob per App, Sprachsteuerung, Fernbedienung und den herkömmlichen Wandschalter.

TRIO luminaires with WiZ technology enable fascinating and innovative lighting settings that can be individually managed, programmed and controlled.

The smart lighting control provides unlimited possibilities to create the desired atmosphere for every occasion - whether via app, voice control, remote control and the conventional wall switch.

Les luminaires TRIO sont dotés de la technologie WIZ. Celle-ci permet une mise en scène fascinante et innovante. Chaque éclairage peut être géré, programmé et contrôlé individuellement.

Le contrôle d'éclairage intelligent offre d'immenses possibilités (ou d'inombrables possibilités). Il permet de créer des atmosphères différentes pour chaque occasion via l'application, le contrôle vocal, la télécommande ou l'interrupteur mural.

TRIO-armaturen met WiZ-technologie maken fascinerende en innovatieve instellingen van de verlichting mogelijk die afzonderlijk kunnen worden beheerd, geprogrammeerd en geregeld.

De slimme lichtregeling biedt onbeperkte mogelijkheden om de gewenste sfeer te creëren voor elke gelegenheid - of dit nu via de app, spraakbesturing, afstandsbediening en de conventionele wandschakelaar is.

Las luminarias TRIO con tecnología WiZ permiten configuraciones de iluminación fascinantes e innovadoras que se pueden gestionar, programar y controlar individualmente.

El control de iluminación inteligente ofrece ilimitadas posibilidades de crear la atmósfera deseada para cada ocasión- vía App, control de voz, control remoto e interruptor de pared convencional.

Gli apparecchi TRIO con tecnologia WiZ consentono impostazioni di illuminazione affascinanti e innovative che possono essere gestite, programmate e controllate individualmente.

Il controllo intelligente dell'illuminazione offre infinite possibilità di creare l'atmosfera desiderata per ogni occasione, tramite app, controllo vocale, telecomando e interruttore a muro convenzionale.

Corpurile de iluminat TRIO cu tehnologia WiZ permit setari inovative si fascinante care pot fi programate si controlate .

Controlul inteligent al iluminatului furnizeaza posibilitati nelimitate pentru a crea atmosfera dorita pentru fiecare ocazie - fie ca este prin aplicatie ,comanda vocala , telecomanda sau intrerupatorul conventional pe perete .

TRIO WiZ teknologialla varustetut valaisimet mahdollistavat lumaavan ja innovatiivisen valaistuksen jota voidaan yksilöllisesti hallinnoida, ohjelmoida ja käyttää.

Älyvalaistus mahdollistaa rajoittamattomat mahdollisuudet luoda erilaisia tunnelmatiloja jokaiseen tilanteeseen - joko appien, puhettunnistuksen, kaukosäätimen tai seinäkytkimen kautta.

Lampy TRIO w technologii WiZ umożliwiają fascynujące i innowacyjne projekty świetlne, które można doskonale sterować, programować i kontrolować w indywidualny sposób.

Inteligentne sterowanie światłem zapewnia przy tym nieograniczone możliwości kreowania pożądanej atmosfery na każdą okazję - czy to za pomocą aplikacji, sterowania głosem, pilota i konwencjonalnych przełączników ściennych.



Sensoren
Sensors



Sommer
Summer



Zeitpläne
Schedules



Warmweiß
Warm white



Tageslicht
Daylight



Momente
Moments



Party
Party



Sprachsteuerung
Voice control



Mojito
Mojito



trio-lighting.com/wiz

FLEXIBLE

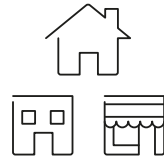

Mehrere Standorte

Kontrollieren und Steuern von mehreren Standorten gleichzeitig und von überall aus. Ob das eigene Zuhause oder die Ferienwohnung.

Multiple locations

Control and command multiple locations simultaneously and from anywhere. Whether your own home or your holiday home.

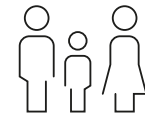

Mehrere Nutzer

Die Anzahl der Nutzer zur Steuerung der Leuchten kann individuell festgelegt werden.

Multiple user

The number of persons to control the lights can be set individually.



Cloud basiert

WiZ verbindet sich mit der Cloud, damit Vorlieben gespeichert, Wünsche geteilt und Updates automatisch generiert werden.

Cloud based

WiZ connects to the cloud to store preferences, share desires and generate updates automatically.



Mehrere Räume

Alle Leuchten können unterschiedlichen Räumen zugeordnet und präzise gesteuert werden – einzeln oder in Gruppen.

Several rooms

All lights can be assigned to different rooms and precisely controlled – individually or in groups.



Keine zusätzliche Bridge erforderlich

Es wird keine zusätzliche Bridge oder Hub für die Steuerung der Leuchten benötigt.

No additional hub needed

There is no need for an additional bridge or hub to control the lights.

SMART



Wlan Technologie

WiZ nutzt Wlan-Technologie als sichere, unabhängige, kostengünstige und einfach zu installierende Funklösung.

WiFi technology

WiZ uses Wi-Fi technology as a secure, independent, affordable and easy-to-install wireless solution.

INNOVATIVE

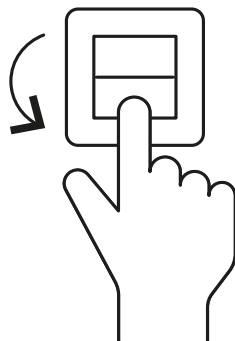

WiZ

CLICK

Einfach und effektiv.
Zwei bevorzugte Lichtmodi können über den vorhandenen Lichtschalter bedient werden.

Simple and effective. Two preferred light modes can be operated via the existing light switch.

177

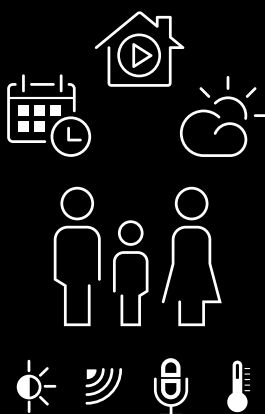

WiZ
MAGIC

Steuerung der Leuchten über Zeitpläne, Sensoren oder einfache Sprachbefehle. Kompatibel mit Amazon Alexa und Google Home.

Control of the lights by time schedules, with sensors or by simple verbal commands. Compatible with Amazon Alexa and Google Home.



WiZ

APP

Einfach und schnell installiert.
Volle Funktionalität und Flexibilität mit der WiZ App – erhältlich im App Store oder bei Google Play.

Easy and quick to install. Full functionality and flexibility with the WiZ App – available on the App Store or on Google Play.



WiZ

MOTE

Steuerung über die Fernbedienung und Abspeichern von vier favorisierten Lichtmodi möglich.

Control via the remote control and possibility to save four favorite light modes.

DIMMEN DIMMING



64.000 **WEISSTÖNE**
64,000 **WHITES**

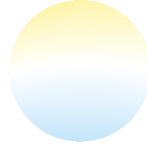

Einstellbare Lichtprogramme · Preset light modes



16 Millionen **FARBEN**
16 million **COLORS**



Dynamische Lichtprogramme · Dynamic light modes



30 Sekunden zur Installation · **30** seconds to install



Die Lampe installieren
Install a lamp



Wählen Sie den „Koppeln“ Modus
Start pairing



3 x EIN / AUS
3 x ON/OFF



Die Lampe beginnt „blau“ zu blinken und
schaltet danach auf weiß
Light turns blue then goes white



Die Einstellungen sind nun gespeichert,
jeder kann zu Hause WiZ nutzen.
The settings are now saved!
Now everyone can use WiZ at your home.



„Alexa, schalte das Licht im Wohnzimmer ein.“
‘Alexa, turn on the light in the living room!’



„OK Google, mach die Lichter grün.“
‘OK Google, turn the lights green!’



Google is a trademark of Google LLC. · Amazon, Alexa and all related logos are trademarks of Amazon.com, Inc. or its affiliates. · Siri is a registered trademark of Apple Inc.

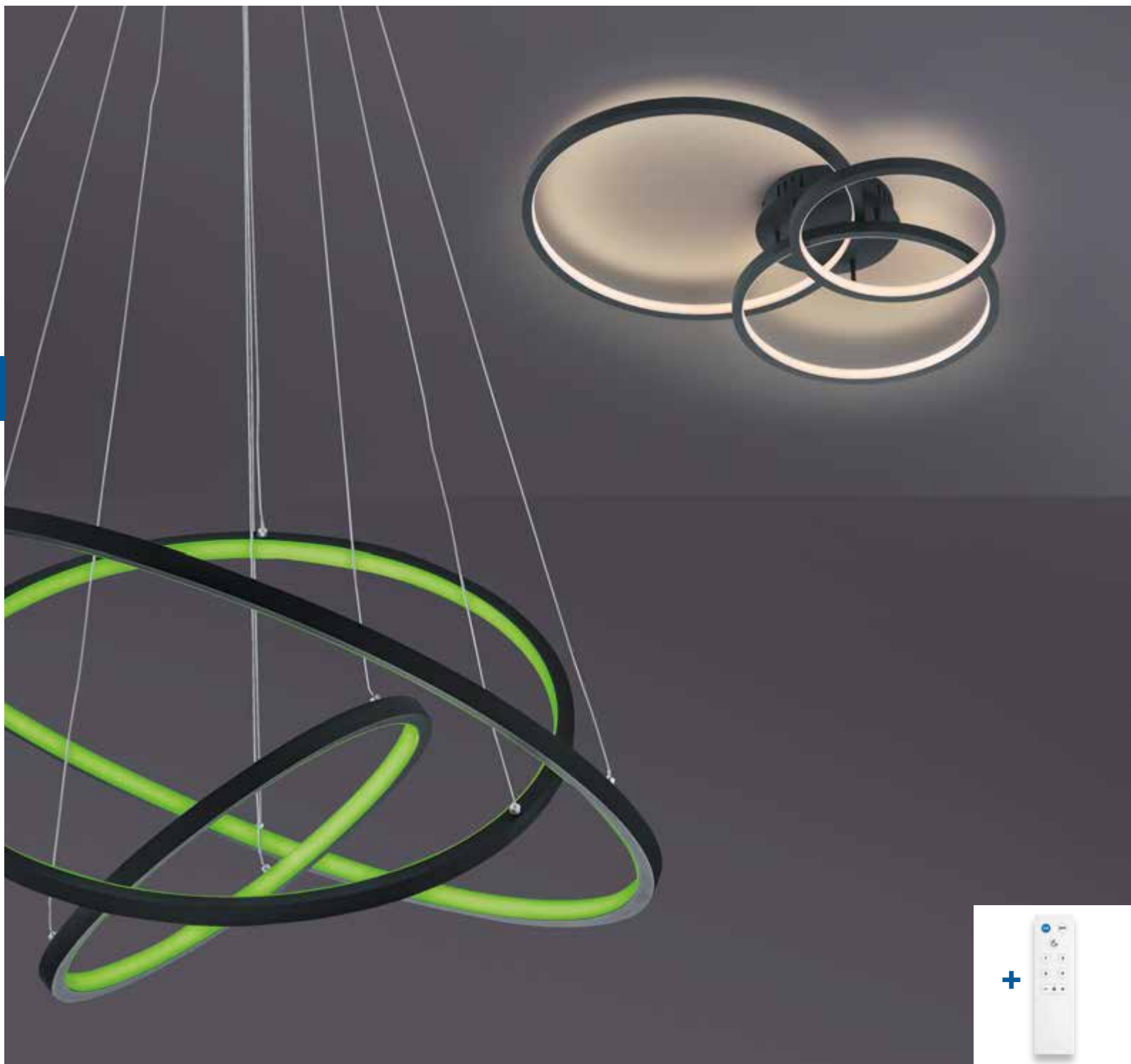

Deckenleuchte · Ceiling lamp

↔ 79 x 64 cm, ↑ 10,5 cm
incl. RGBW-LED, 36 W
3.000 lm, 3.000 - 6.000 K



652710307
652710342

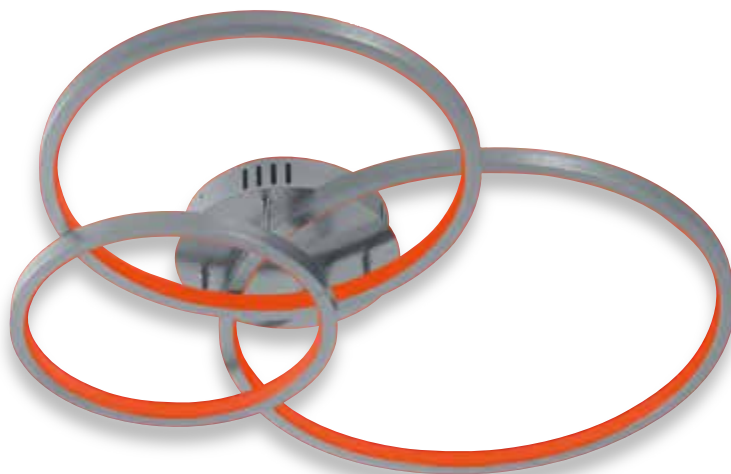

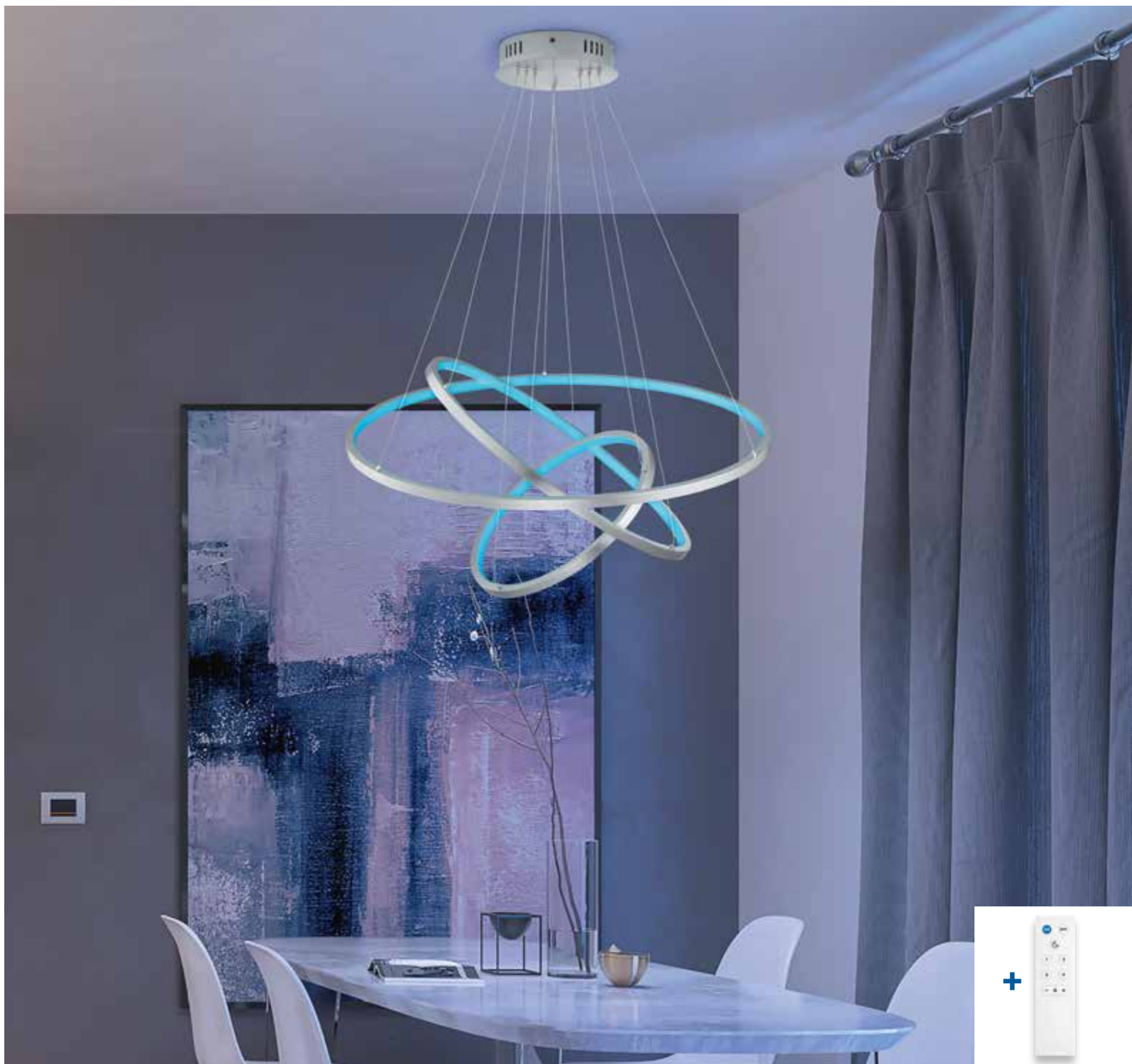

AARON

Metall, Nickel matt oder Anthrazit · metal, nickel mat or anthracite ·
 metale, nickel mat ou antracite · metaal, nikkell mat of antraciet ·
 metal, níquel mate o antracita · metallo, nichel opaco o antracite ·
 metal, nichel mat sau antracit · metalli, harjattu teräs tai antrasiitti ·
 metal, nikiel mat lub antracyt

SMART LIGHTING



07 | Nickel matt · nickel mat



42 | Anthrazit · anthracite



Pendelleuchte · Pendant
 Ø 80 cm, ↓ 150 cm
 incl. RGBW-LED, 80 W
 7.000 lm, 3.000 - 6.000 K



352710307
 352710342



CITIZEN

Metall, Nickel matt oder Schwarz matt · metal, nickel mat or black mat ·
 metale, nikel mat ou noir mat · metaal, nikkel mat of mat zwart ·
 metal, níquel mate o estera negra · metallo, nichel opaco o nero opaco ·
 metal, nichel mat sau negru mat · metalli, harjattu teräs tai mattamusta ·
 metal, nikiel mat lub czarny mat

SMART LIGHTING



07 | Nickel matt · nickel mat



32 | Schwarz matt · black mat

Deckenleuchte · Ceiling lamp
 ↔ 94,5 x 55 cm, ↓ 8 cm
 incl. 2 x RGBW-LED, 17 W
 max. 2 x 1.700 lm, 3.000 - 5.000 K



651110207
 651110232



THIAGO

Metall, Nickel matt oder Anthrazit · metal, nickel mat or anthracite ·
 metale, nickel mat ou antracite · metaal, nikkell mat of antraciet ·
 metal, níquel mate o antracita · metallo, nichel opaco o antracite ·
 metal, nichel mat sau antracit · metalli, harjattu teräs tai antrasiitti ·
 metal, nikiel mat lub antracyt



07 | Nickel matt · nickel mat



32 | Schwarz matt · black mat

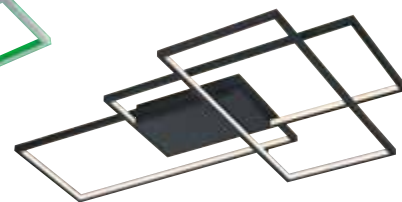
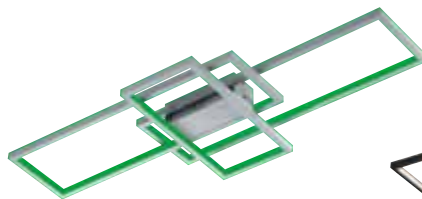

Deckenleuchte · Ceiling lamp

↔ 104 x 42 cm, ↑ 8,5 cm
 incl. RGBW-LED, 36 W
 3.000 lm, 3.000 - 6.000 K



652610307
 652610342

Deckenleuchte · Ceiling lamp

↔ 114 x 75 cm, ↑ 8,5 cm
 incl. RGBW-LED, 40 W
 3.400 lm, 3.000 - 6.000 K



652690307
 652690342

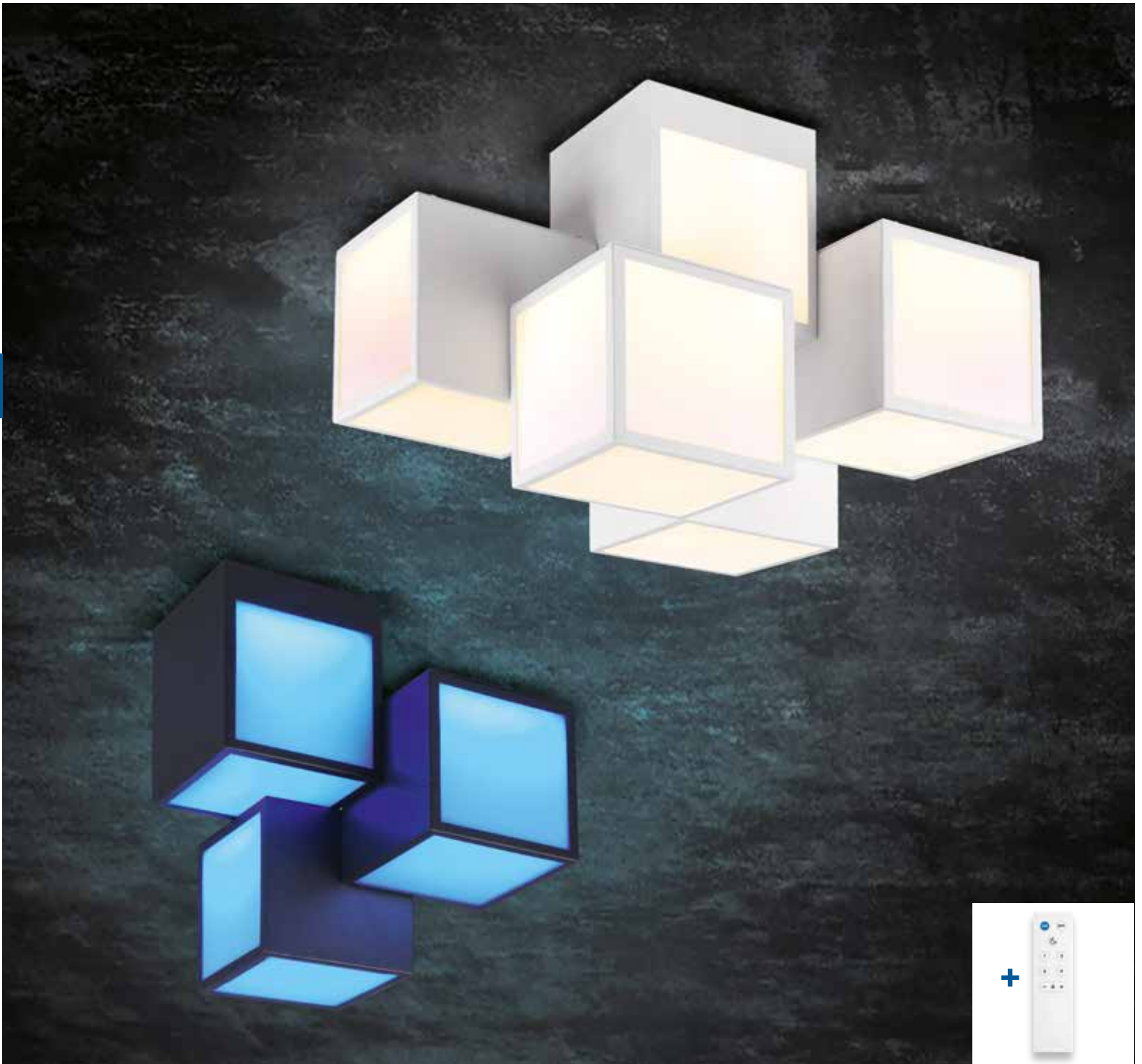

OSCAR

Metall, Weiß matt oder Schwarz matt, Acryl · metal, white mat or black mat, acryl ·
 metale, blanc mat ou noir mat, acryl · metaal, wit mat of mat zwart, acryl ·
 metal, estera blanca o estera negra, acrílico · metallo, bianco opaco o nero opaco, acrilico ·
 metal, alb mat sau negru mat, acrilic · metalli, mattavalkoinen tai mattamusta, akryyli ·
 metal, biały mat lub czarny mat, akryl

SMART LIGHTING



31 | Weiß matt · white mat



32 | Schwarz matt · black mat



Deckenleuchte · Ceiling lamp

↔ 30 x 30 cm, ↑ 32,5 cm
 incl. 3 x RGBW-LED, 8 W
 3 x 700 lm, 3.000 - 6.000 K



652810331
 652810332

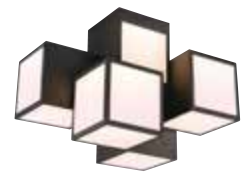

Deckenleuchte · Ceiling lamp

↔ 45 x 30 cm, ↑ 32,5 cm
 incl. 5 x RGBW-LED, 7 W
 5 x 600 lm, 3.000 - 6.000 K



652810531
 652810532

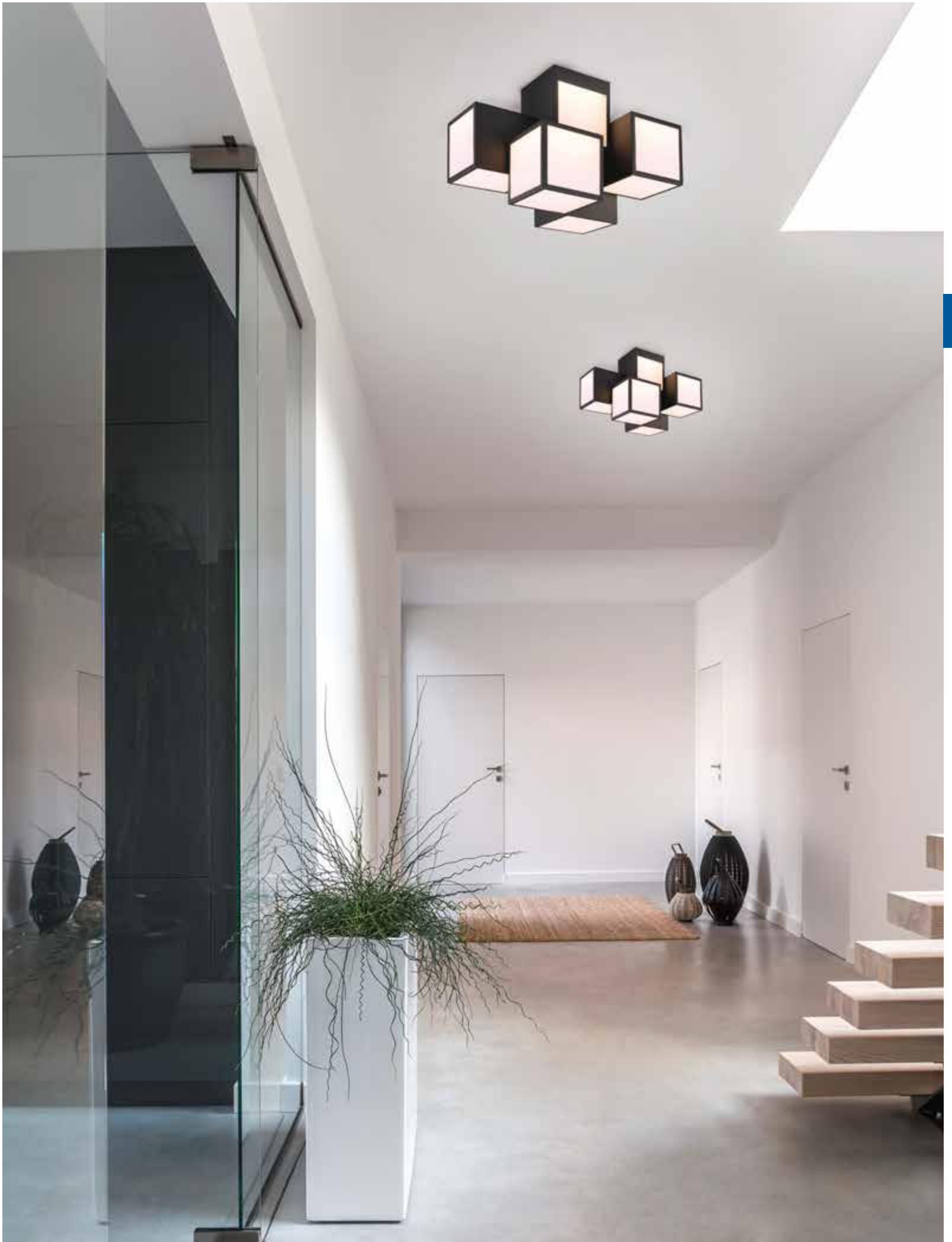

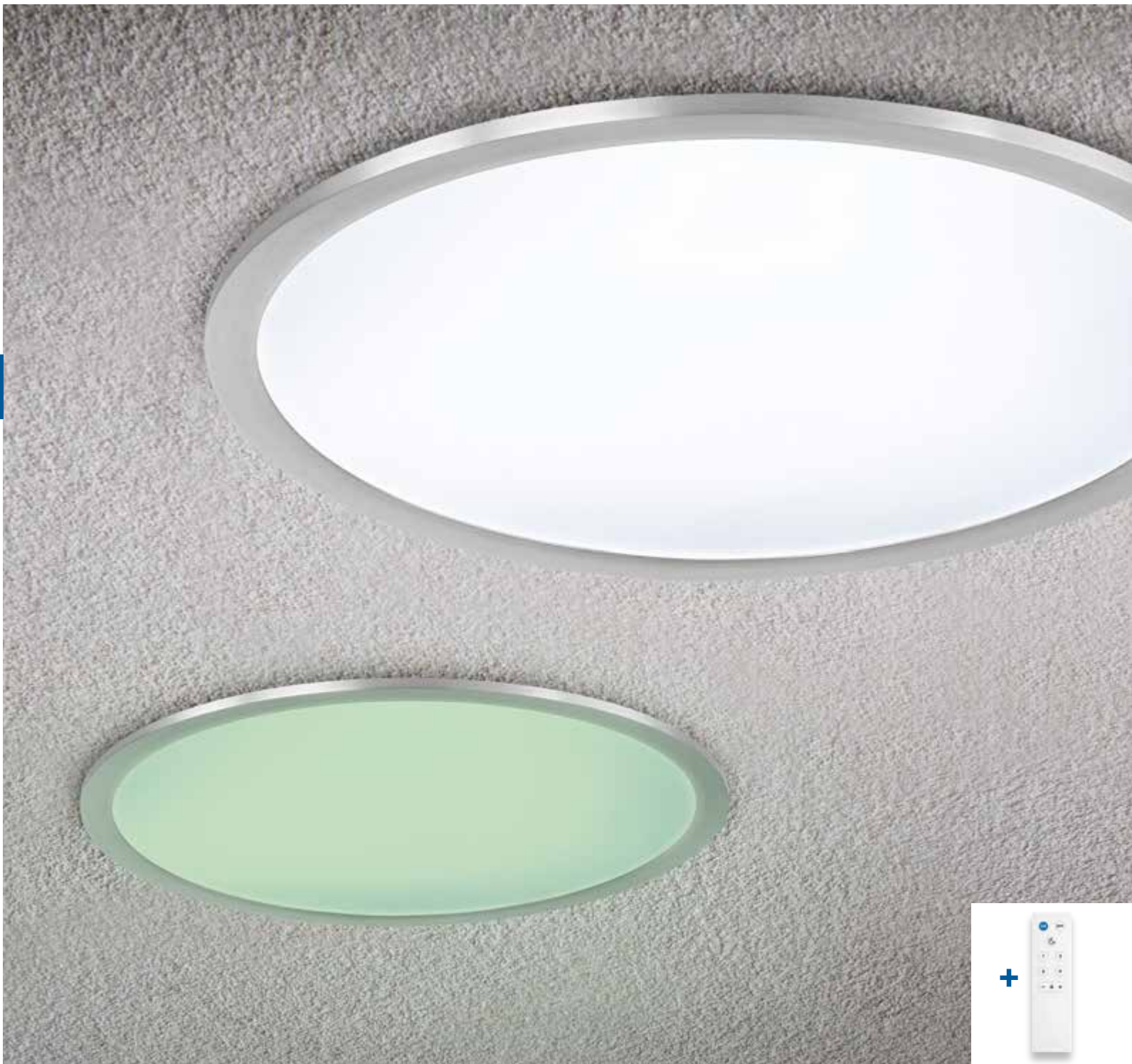

Deckenleuchte · Ceiling lamp
 Ø 30 cm, ↓ 5 cm
 incl. SMD-LED, 15 W
 1.500 lm, 3.000 - 5.500 K



657493007



Deckenleuchte · Ceiling lamp
 Ø 40 cm, ↓ 5 cm
 incl. SMD-LED, 20 W
 2.000 lm, 3.000 - 5.500 K



657494007



Deckenleuchte · Ceiling lamp
 Ø 60 cm, ↓ 5 cm
 incl. SMD-LED, 36 W
 3.600 lm, 3.000 - 5.500 K



657496007



Deckenleuchte · Ceiling lamp
 ↔ 29,5 x 29,5 cm, ↓ 5 cm
 incl. SMD-LED, 15 W
 1.500 lm, 3.000 - 5.500 K



657413007

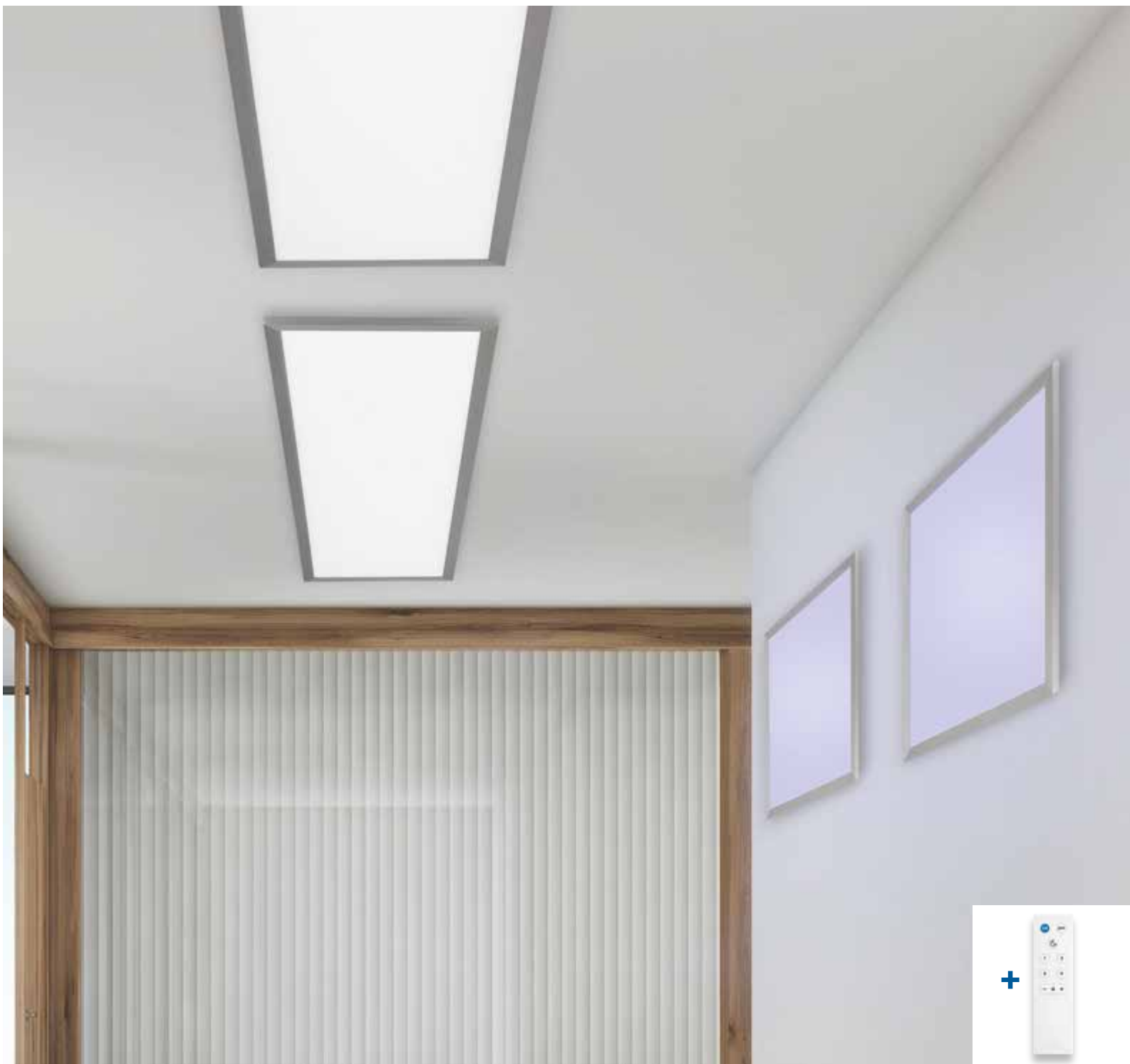

GRIFFIN

Nickel matt, Acryl · nickel mat, acryl ·
 nickel mat, acryl · nikkel mat, acryl · níquel mate, acrílico · nichel opaco, acrilico ·
 nichel mat, acrilic harjattu teräs, akryyli · nikiel mat, akryl

SMART LIGHTING



Deckenleuchte · Ceiling lamp
 ↔ 39,5 x 39,5 cm, ↓ 5 cm
 incl. SMD-LED, 20 W
 2.000 lm, 3.000 - 5.500 K



657414007



Deckenleuchte · Ceiling lamp
 ↔ 59,5 x 59,5 cm, ↓ 5 cm
 incl. SMD-LED, 36 W
 3.600 lm, 3.000 - 5.500 K



657416007



Deckenleuchte · Ceiling lamp
 ↔ 109,5 x 29,5 cm, ↓ 5 cm
 incl. SMD-LED, 36 W
 3.600 lm, 3.000 - 5.500 K



657411107

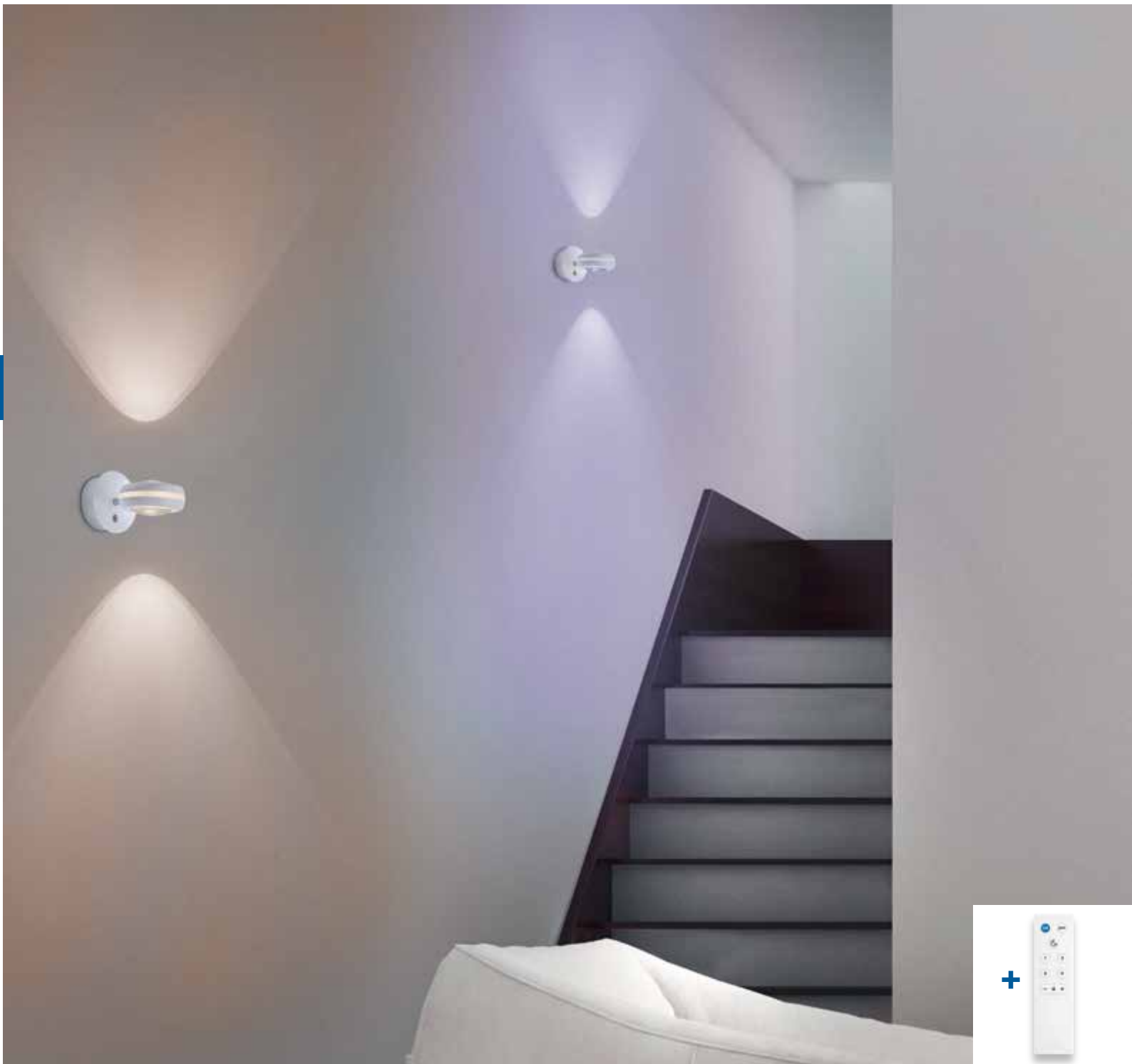

VISTA

Nickel matt oder Weiß matt · nickel mat or white mat ·
 nickel mat ou blanc mat · nikkell mat of wit mat ·
 níquel mate o estera blanca · nichel opaco o bianco opaco ·
 nichel mat sau alb mat · harjattu teräs tai valkoinen matto ·
 nikiel mat lub biały mat

Wandleuchte · Wall lamp

Ø 11 cm, ʘ 17,5 cm

incl. 2 x RGBW-LED, 3,8 W

2 x 380 lm, 3.000 - 5.000 K



255410207

255410231



07 | Nickel matt · nickel mat



31 | Weiß matt · white mat

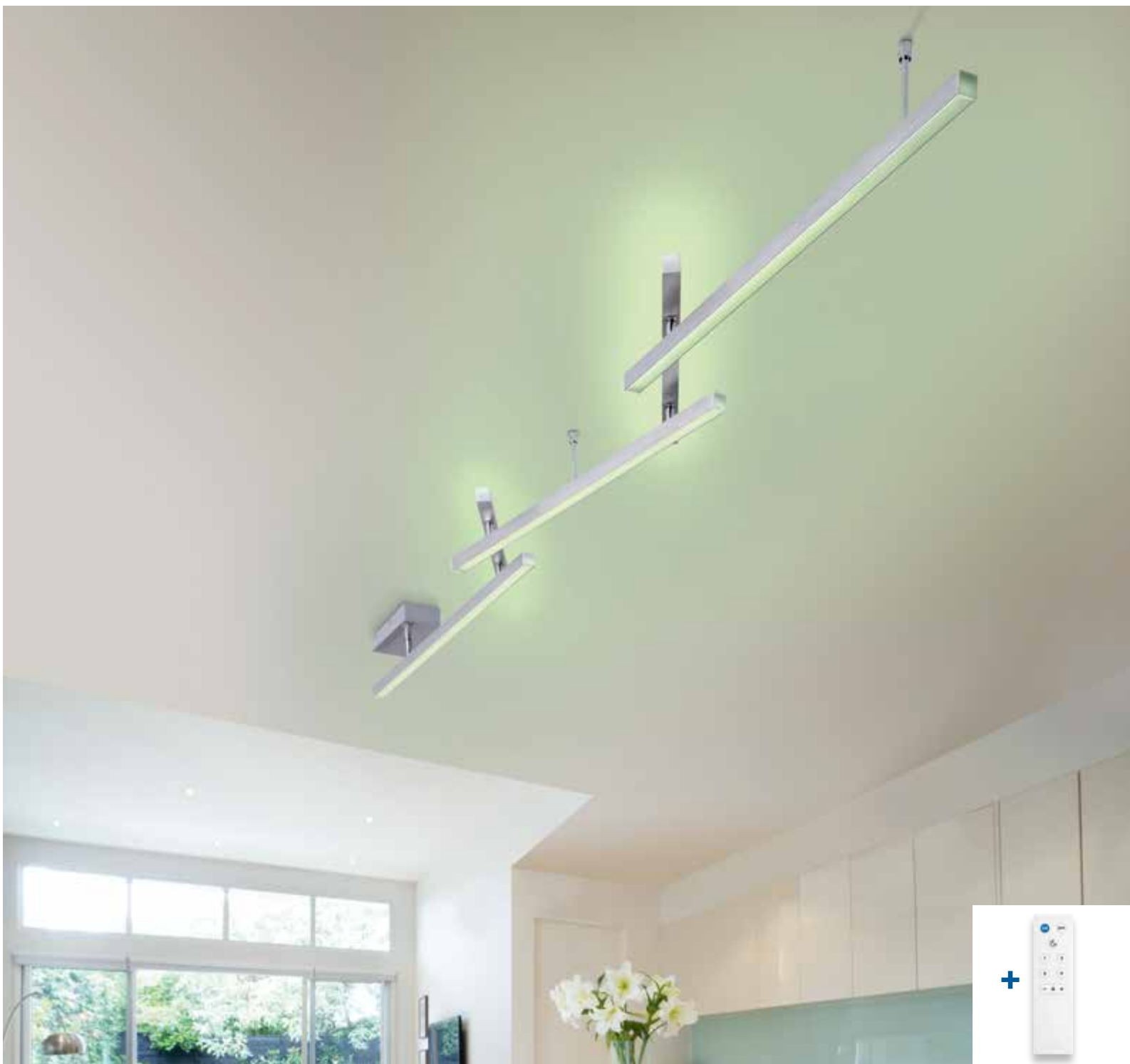

MELBY

Nickel matt, Acryl · nickel mat, acryl ·
 nickel mat, acryl · nikkel mat, acryl · níquel mate, acrílico ·
 nichel opaco, acrílico · nichel mat, acrílico · harjattu teräs, akryyli ·
 nikiel mat, akryl

Direkte und indirekte Beleuchtung · up and down lighting ·
 point lumineux en haut et en bas · lichtpunt boven en onder ·
 luz de arriba y abajo · luce su e giù · sus și în jos lumina ·
 ylös ja alas valoa · w górę iw dół światło

SMART LIGHTING

Deckenleuchte · Ceiling lamp

↔ max. 242 x 10 cm, ↑ 12 cm
 incl. RGBW-LED, 23 W
 max. 2.200 lm, 3.000 - 5.000 K



651210507

CHARLY

Acryl, weiß · acryl, white ·
acryl, blanc · acryl, wit · acrílico, blanco · acrílico, bianco ·
acrilic, alb · akryyli, valkoinen · akryl, biały



Deckenleuchte · Ceiling lamp

Ø 50 cm, ↑ 12 cm

incl. RGBW-LED, 27 W

max. 2.550 lm, 3.000 - 5.500 K



656010100



Deckenleuchte · Ceiling lamp

Ø 50 cm, ↑ 12 cm

incl. RGBW-LED, 27 W

max. 2.550 lm, 3.000 - 5.500 K



656010101



SMART LIGHTING

NALIDA

Acryl, weiß · acryl, white ·
acryl, blanc · acryl, wit · acrílico, blanco · acrílico, bianco ·
acrilic, alb · akryyli, valkoinen · akryl, biały

Deckenleuchte · Ceiling lamp

Ø 74 cm, ↑ 10 cm

incl. RGBW-LED, 40 W

max. 3.700 lm, 3.000 - 5.500 K



656090100





PANTILON

Acryl, weiß · acryl, white ·
 acryl, blanc · acryl, wit · acrílico, blanco ·
 acrilico, bianco · acrilic, alb · akryyli, valkoinen ·
 akryl, biały

**SMART
 LIGHTING**

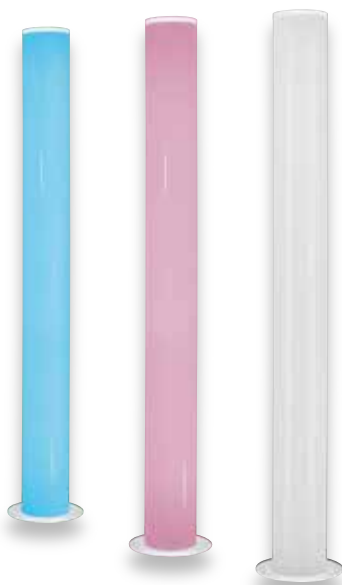

Stehleuchte · Floor lamp

↑ 150 cm, Ø 24 cm

incl. SMD-LED, 22 W

2.200 lm, 3.000 - 6.000 K



451850101

FIGO

Metall · metal ·
metale · metaal · metal · metallo · metal · metalli · metal

 **05** | Aluminium gebürstet · brushed aluminium

 **31** | Weiß matt · white mat

 **32** | Schwarz matt · black mat

Wandleuchte · Wall lamp

↔ 10 x 10 cm, √ 10 cm

incl. RGBW-LED, 5,5 W

450 lm, 3.000 - 6.500 K



253310105

253310131

253310132

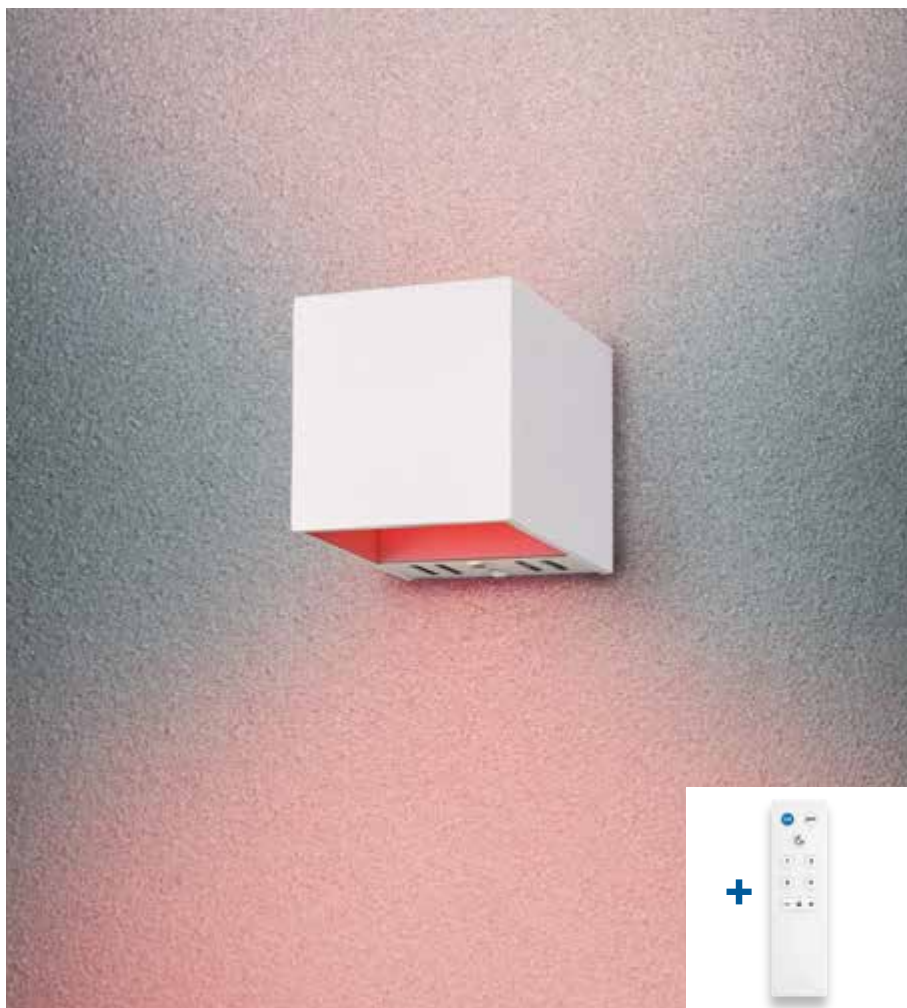

ADRIANA

Metall · metal ·
metale · metaal · metal · metallo · metal · metalli · metal

 **07** | Nickel matt · nickel mat

 **31** | Weiß matt · white mat

 **32** | Schwarz matt · black mat

Wandleuchte · Wall lamp

↔ 30 x 6 cm, √ 9 cm

incl. RGBW-LED, 5,5 W

450 lm, 3.000 - 6.500 K



250810207

250810231

250810232



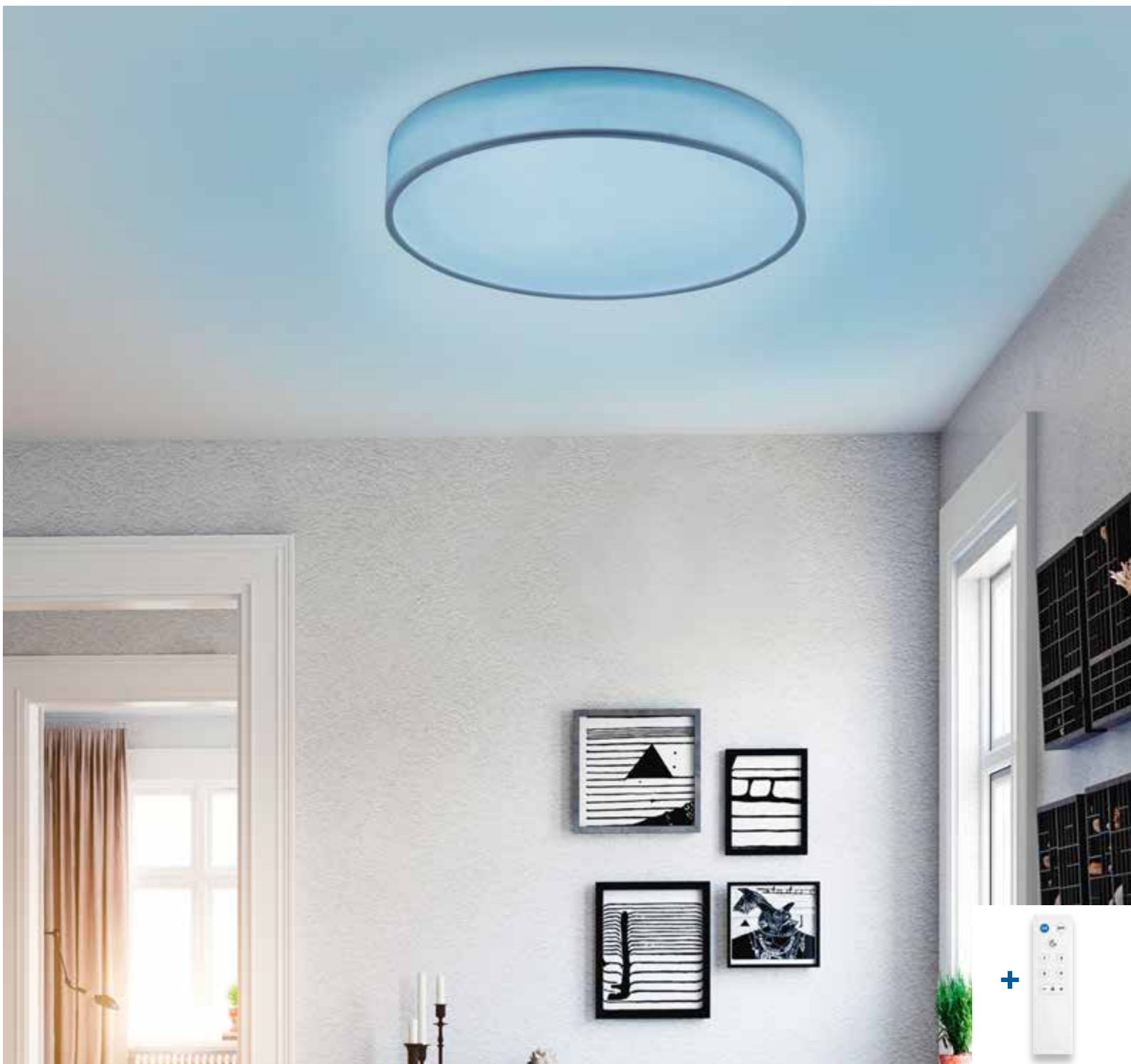

DIAMO

Stoff weiß · fabric white ·
tissu blanc · textiel wit · tela blanco · tessuto bianco ·
textil alb · tekstiili valkoinen · tkanina biały

SMART LIGHTING



Deckenleuchte · Ceiling lamp
Ø 60 cm, ↑ 10 cm
incl. RGBW-LED, 36 W
max. 3.400 lm, 3.000 - 5.000 K



651914001



Deckenleuchte · Ceiling lamp
Ø 75 cm, ↑ 10 cm
incl. 1 x RGBW-LED, 45 W
max. 4.200 lm, 3.000 - 5.000 K



651915501

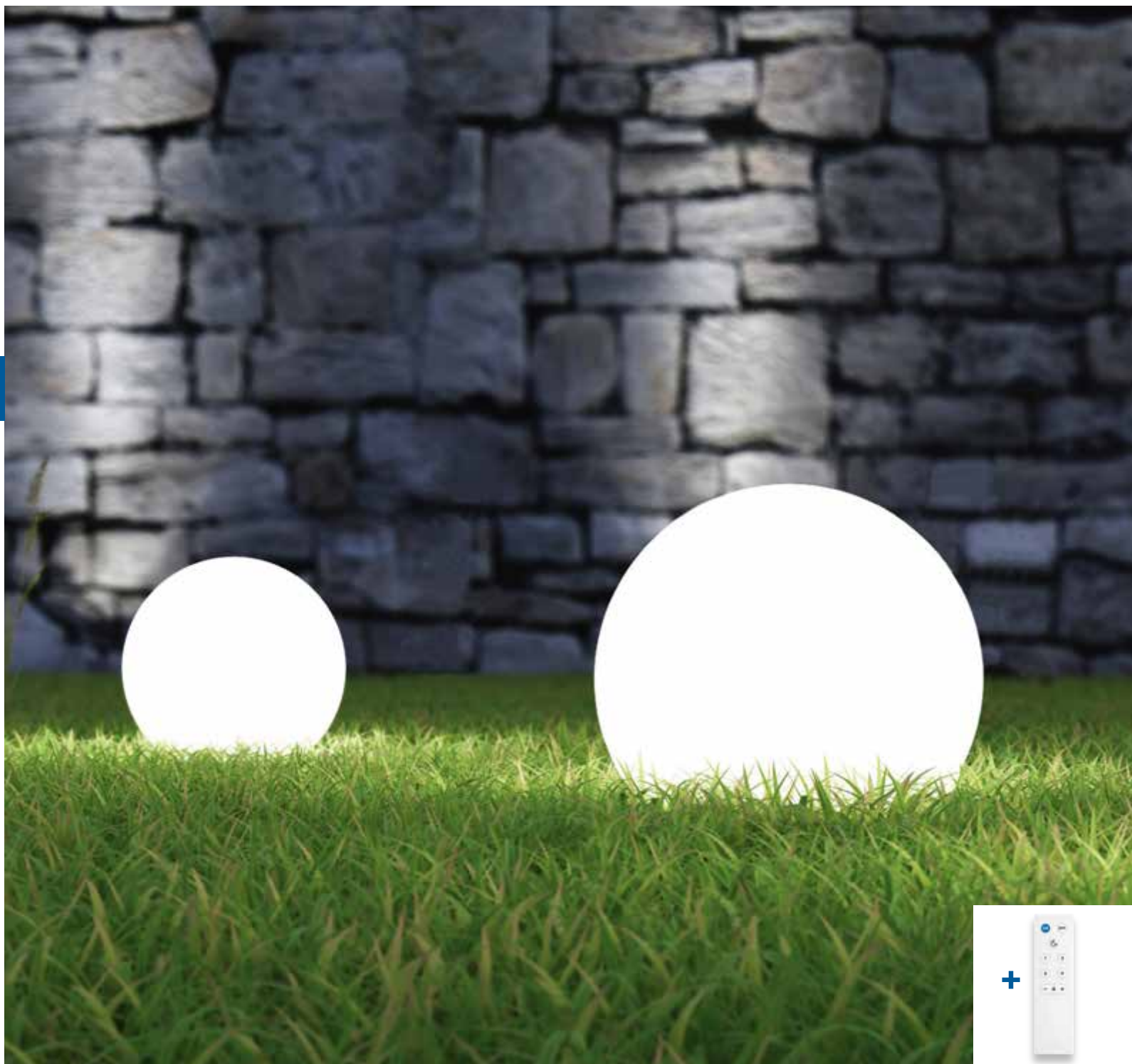

NECTOR

Kunststoff, weiß · plastic, white ·
 plastique, blanc · kunststof, wit · plástico, blanco ·
 plastica, bianco · plastic, alb · muovi, valkoinen · plastik, biały

SMART LIGHTING

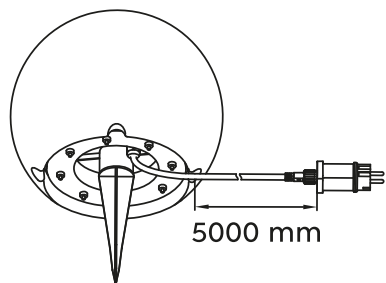

Gartenleuchte · Garden lamp
 Ø 30 cm, ↑ 25,5 cm
 incl. RGBW-LED, 8,5 W
 600 lm, 3.000 - 5.500 K



551753001



Gartenleuchte · Garden lamp
 Ø 40 cm, ↑ 37 cm
 incl. RGBW-LED, 8,5 W
 600 lm, 3.000 - 5.500 K



551754001

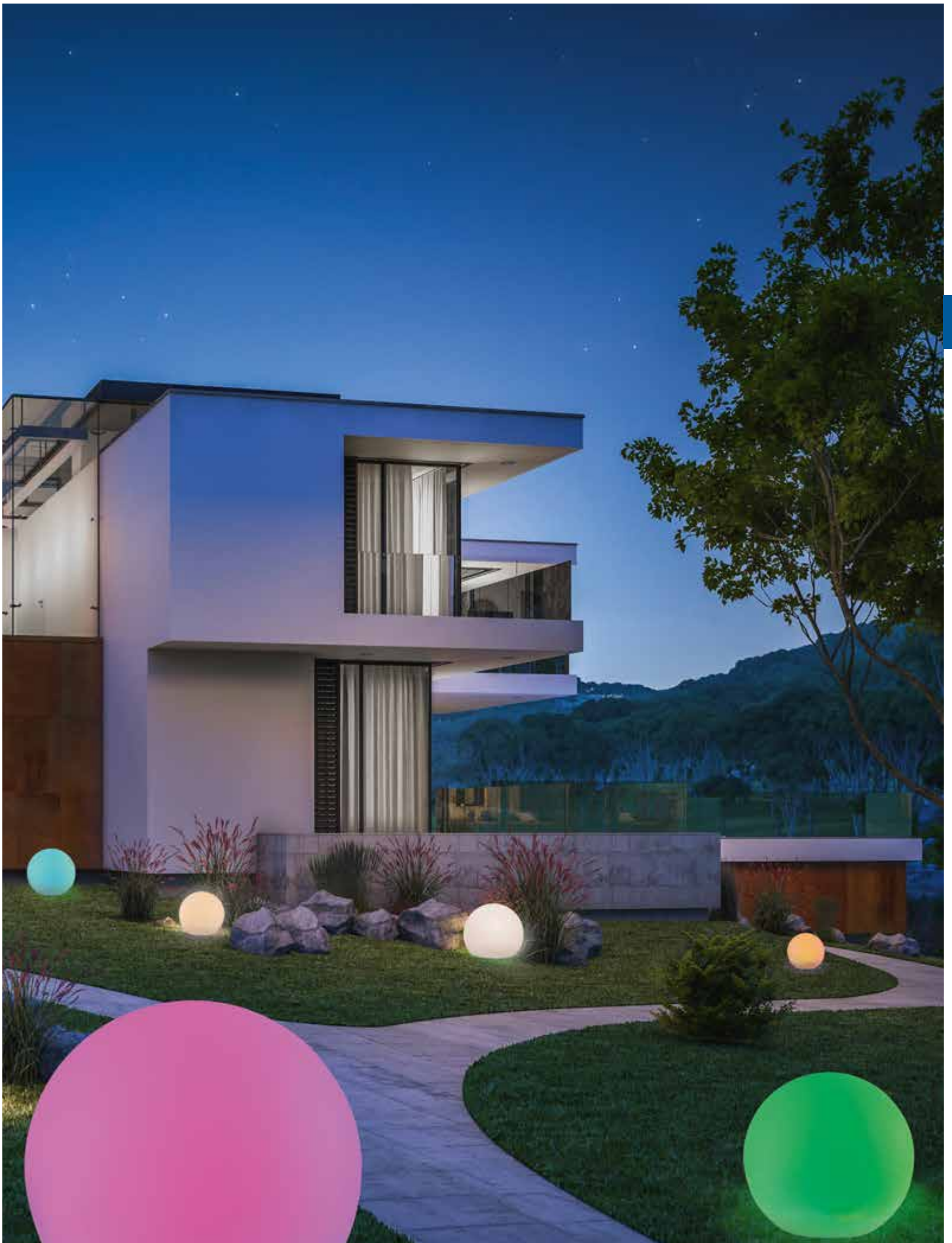





196 - 247

Pendelleuchten & Kronen

Pendants & chandeliers

Lustres & suspensions

Hanglampen & kroonluchters

Colgantes y Lámparas

Lampadari e sospensioni

Lustre si pendule

Riippu- & kruunu

Wiszące i żyrandole



Pendelleuchte · Pendant

↔ 95 - 150 cm, ↓ 95 - 150 cm
 incl. SMD-LED, 42 W, 4.000 lm
 incl. 2 x SMD-LED, 6 W, 2 x 500 lm
 2.700 - 5.000 K



375310502
 375310505
 375310507
 375310508
 375310532



-  **02** | Schwarz / Messing matt · black / brass mat
-  **05** | Aluminium gebürstet · brushed aluminium
-  **07** | Nickel matt · nickel mat
-  **08** | Messing matt · brass mat
-  **32** | Schwarz matt · black mat



TRAJAN

Metall · metal ·
metale · metaal · metal · metallo · metal · metalli · metal



Lichtfarbe stufenlos einstellbar ·
Light color infinitely variable



4 fach TOUCH ·
4 level Touch function

Ausziehbar · Extendible · extensible · Verlengbaar ·
Extensible · Estensibile · extensibil · Jatkettava · Rozsuwalny

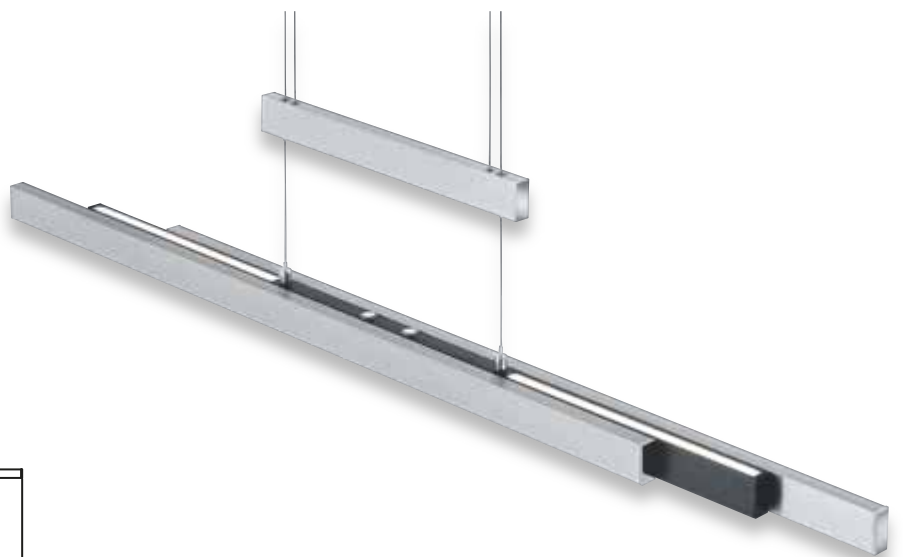
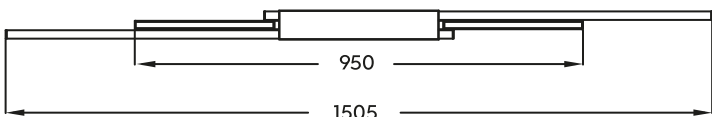

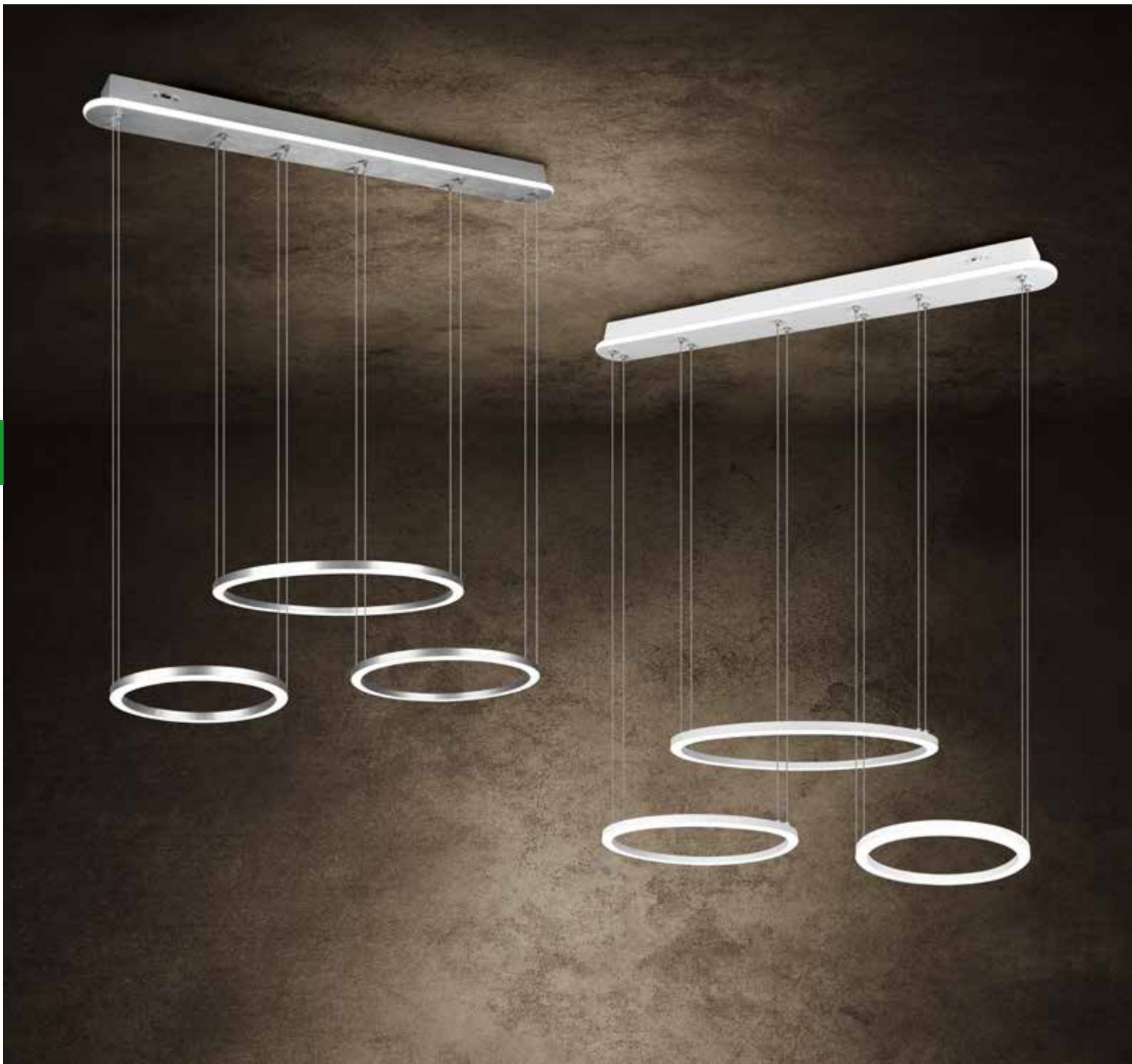

DIP SWITCH

Lichtfarben direkt an der Leuchte einstellbar · Colours directly adjustable at the lamp ·
 Les couleurs de la lumière peuvent être réglées directement sur le luminaire ·
 Lichtkleuren direct instelbaar op de lamp · Tonalidades de luz ajustables directamente en la lámpara ·
 Colori della luce regolabili direttamente sulla lampada · Culori ale luminii reglabile direct de la bec ·
 Valon väri asetettävissa suoraan valaisimesta · Barwy światła można ustawić bezpośrednio na oprawie



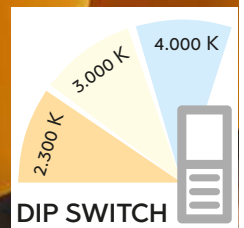

MORRISON

Metall, Acryl · metal, acryl ·
metale, acryl · metaal, acryl · metal, acrílico ·
metallo, acrilico · metal, acrylic · metalli, akryyli · metal, akryl



DIP SWITCH



SWITCH DIMMER



07 | Nickel matt · nickel mat



31 | Weiß matt · white mat



32 | Schwarz matt · black mat

Pendelleuchte · Pendant
↔ 90 x 50 cm, ↓ 150 cm
incl. SMD-LED, 56 W
6.800 lm, 2.300 + 3.000 + 4.000 K



323610307
323610331
323610332

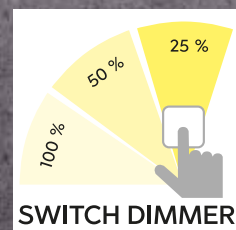

SWITCH DIMMER

DURBAN

Metall, Nickel matt oder Anthrazit · metal, nickel mat or anthracite ·
 metale, nickel mat ou antracite · metaal, nikkell mat of antraciet ·
 metal, níquel mate o antracita · metallo, nichel opaco o antracite ·
 metal, nichel mat sau antracit · metalli, harjattu teräs tai antrasiitti ·
 metal, nikiel mat lub antracyt



07 | Nickel matt · nickel mat



42 | Anthrazit · anthracite



Pendelleuchte · Pendant
 Ø 60,3 cm, ↑ 200 cm
 incl. SMD-LED, 40 W
 5.000 lm, 3.000 K



321910207
 321910242



Pendelleuchte · Pendant
 Ø 80,3 cm, ↑ 200 cm
 incl. SMD-LED, 75 W
 8.000 lm, 3.000 K



321910307
 321910342

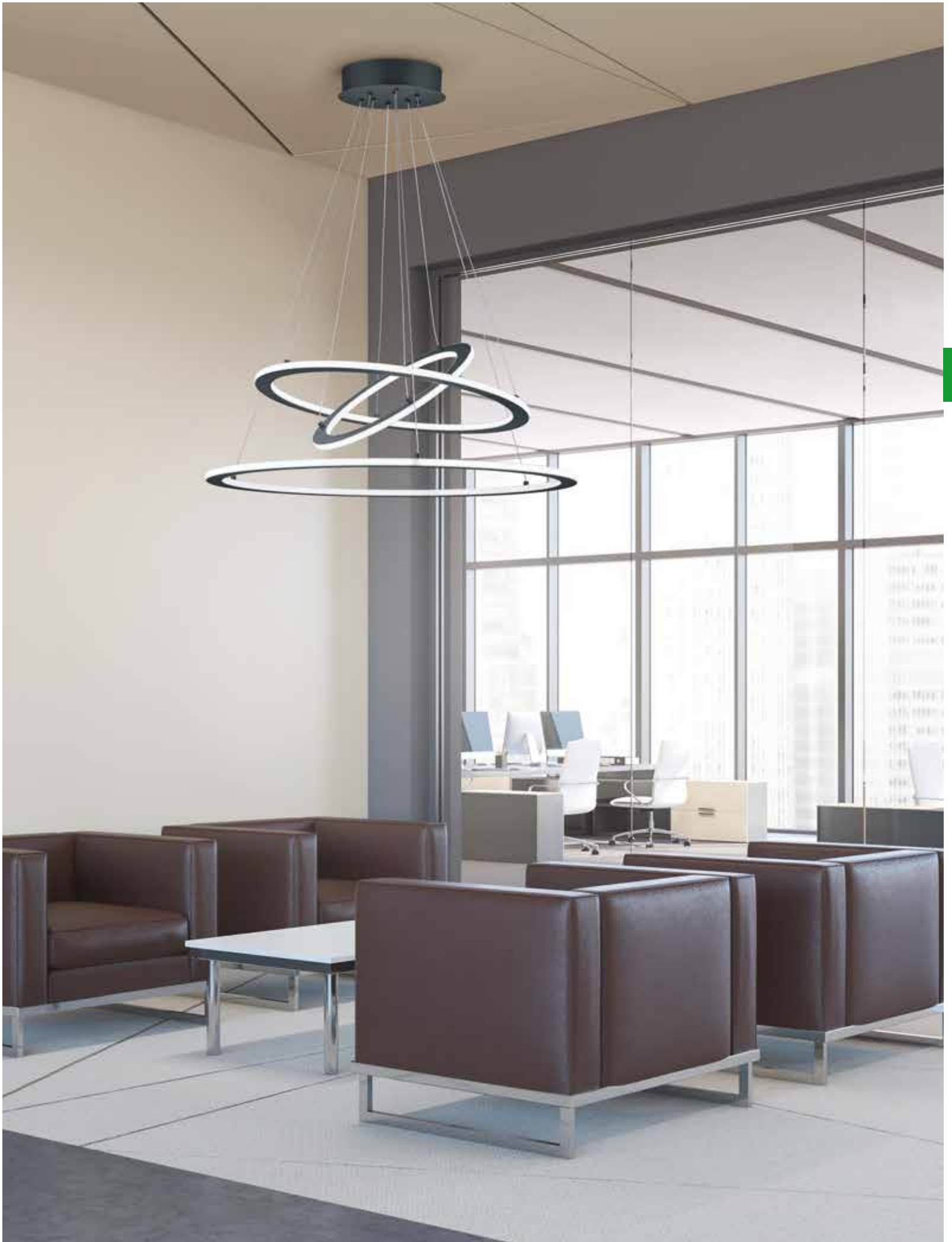



CURL

Metall, Weiß matt, Schwarz matt oder goldfarbig · metal, white mat, black mat or gold ·
 metale, blanc mat, noir mat ou or · metaal, wit mat, mat zwart of goud · metal, estera blanca, estera negra o oro · metallo, bianco opaco, nero opaco o oro ·
 metal, alb mat, negru mat sau aur · metalli, mattavalkoinen, mattamusta tai kultaa · metal, biały mat, czarny mat lub złota

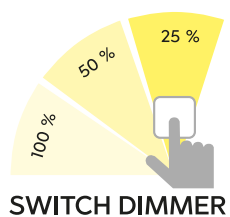

SWITCH DIMMER



31 | Weiß matt · white mat

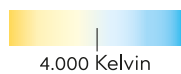

4.000 Kelvin



32 | Schwarz matt · black mat



79 | goldfarbig · gold

Pendelleuchte · Pendant
 Ø 55 cm, ↑ 150 cm
 incl. SMD-LED, 33 W
 2.800 lm, 3.000 K
 (31 = 3.500 lm, 4.000 K)



325110131
325110132
325110179





MACAU

Aluminium gebürstet · brushed aluminium ·
 aluminium balayé · geborsteld aluminium · aluminio pulido ·
 alluminio spazzolato · aluminiu lucios · harjattu alumiini ·
 aluminium szczotkowane

Pendelleuchte · Pendant

Ø 75 cm, ↑ max. 200 cm
 incl. SMD-LED, 64 W
 6.000 lm, 3.000 K



325610305

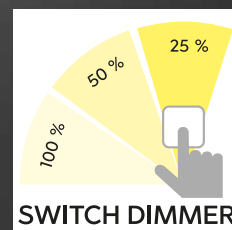

AICK

Metall, Aluminium gebürstet oder schwarz matt · metal, brushed aluminium or black mat ·
 metale, aluminium balayé ou noir mat · metaal, geborsteld aluminium of mat zwart ·
 metal, aluminio pulido o estera negra · metallo, alluminio spazzolato o nero opaco ·
 metal, aluminiu lucios sau negru mat · metalli, harjattu alumiini tai mattamusta ·
 metal, aluminium szczotkowane lub czarny mat



05 | Aluminium gebürstet · brushed aluminium



32 | Schwarz matt · black mat



Pendelleuchte · Pendant
 ↔ 110 x 7,5 cm, ↑ 150 cm
 incl. SMD-LED, 38 W
 4.500 lm, 3.000 K



327210305
327210332



CAVALLO

Aluminium gebürstet · brushed aluminium ·
aluminium balayé · geborsteld aluminium · aluminio pulido ·
alluminio spazzolato · aluminiu lucios · harjattu alumiini ·
aluminium szczotkowane

Pendelleuchte · Pendant
↔ 100 x 5 cm, ↑ 95 - 160 cm
incl. 5 x SMD-LED, 4,3 W
5 x 430 lm, 3.000 K



379090505



4 fach TOUCH ·
4 level Touch function



LACAL

Nickel matt oder goldfarbig · nickel mat or gold ·
 nickel mat ou or · nikkell mat of goud · níquel mate o oro ·
 nichel opaco o oro · nichel mat sau aur · harjattu teräs tai kultaa · nikiel mat lub złota

Gibt Licht nach oben und unten · up and down lighting ·
 point lumineux en haut et en bas · lichtpunt boven en onder · luz de arriba y abajo ·
 luce su e giù · sus și în jos lumina · ylös ja alas valoa · w górę iw dół światło

 Lichtfarbe einstellbar ·
 Adjustable light color

 4 fach TOUCH ·
 4 level Touch function



Pendelleuchte · Pendant
 ↔ 100 cm, ↓ 95 - 160 cm
 incl. 7 x SMD-LED, 3,5 W
 7 x 350 lm, 3.000 + 5.000 K



379190707 | Nickel matt · nickel mat
 379190732 | Schwarz matt · black mat

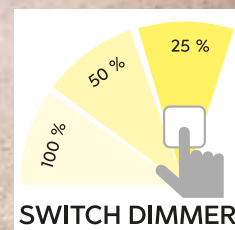

ALEGRO

Nickel matt, Glas opal · nickel mat, opal glass ·
 nickel mat, verre opale · nikkel mat, opaal glas · níquel mate, vidrio opal ·
 nichel opaco, vetro opale · nichel mat, sticla opala · harjattu teräs, opaailasi ·
 nikiel mat, szkło opal



LIFT ME

Innovative Höhenverstellung ohne Gegengewicht ·
 Innovative height adjustment without counterweight ·
 Nouveau! Réglage de la hauteur sans contrepoids ·
 Innovatieve hoogteverstelling zonder contragewicht ·
 Innovador sistema de ajuste de altura sin necesidad de contrapeso ·
 Regolazione innovativa dell'altezza senza contrappeso ·
 Ajustare inovativa a inaltimii fara contragreutate ·
 Innovatiivinen korkeuden säätö ilman vastapainoa ·
 Innowacyjna regulacja wysokości bez przeciwwagi



Pendelleuchte · Pendant
 ↔ 100 x 12 cm, ↑ 95 - 160 cm
 incl. 4 x SMD-LED, 6 W
 4 x 630 lm, 3.000 K



325510407



Pendelleuchte · Pendant
 ↔ 130 x 12 cm, ↑ 95 - 160 cm
 incl. 5 x SMD-LED, 6 W
 5 x 630 lm, 3.000 K



325510507

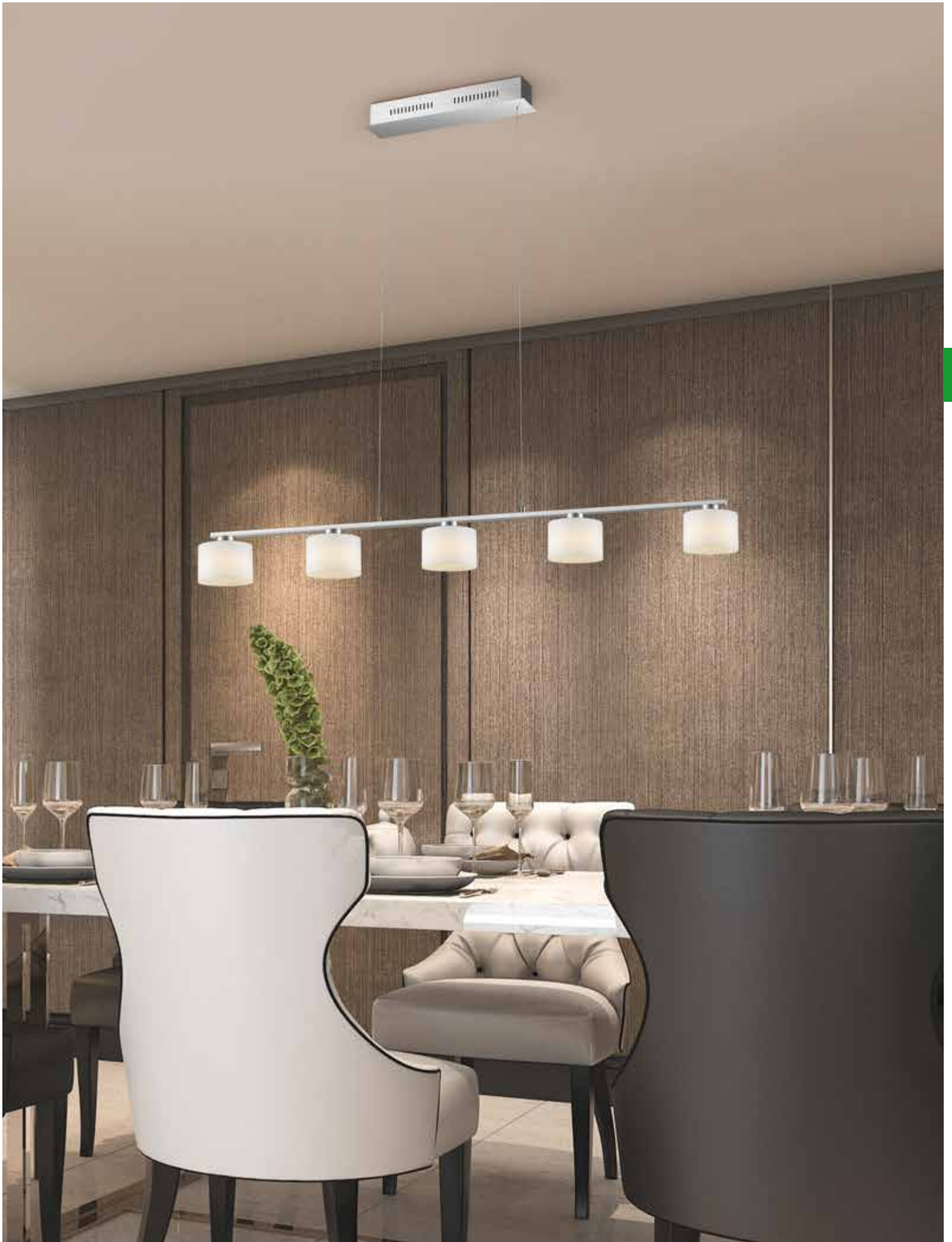



CALVARO

Aluminium gebürstet, Acryl · brushed aluminium, acryl ·
 aluminium balayé, acryl · geborsteld aluminium, acryl ·
 aluminio pulido, acrílico · alluminio spazzolato, acrilico ·
 aluminiu lucios, acrilic · harjattu alumiini, akryyli ·
 aluminium szczotkowane, akryl

Pendelleuchte · Pendant

↔ 80 x 2,5 cm, ↑ 90 - 150 cm
 incl. SMD-LED, 20 W
 1.900 lm, 3.000 K



377690105



4 fach TOUCH ·
 4 level Touch function



STAKKATO

Nickel matt, Glas satiniert · nickel mat, satinated glass ·
 nickel mat, verre satiné · nikkell mat, gesatineerd glas ·
 níquel mate, vidrio satinado · nichel opaco, vetro satinato ·
 nichel mat, sticla satinata · harjattu teräs, satinoitu lasi ·
 nikiel mat, szkło satynowe

Pendelleuchte · Pendant
 ↔ 87 x 10 cm, ↓ 95 - 150 cm
 incl. 3 x SMD-LED, 4,5 W
 3 x 430 lm, 3.000 K



377310307





2.700 K



3.800 K



5.000 K

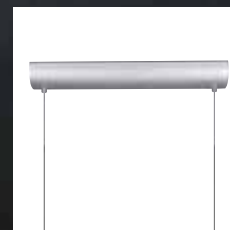

COVENTRY

Metall, Anthrazit oder titanfarbig · metal, anthracite or titan ·
 metale, antracite ou titane · metaal, antraciet of titaan · metal, antracita o titán ·
 metallo, antracite o titano · metal, antracit sau titaniu · metalli, antrasiitti tai titaani ·
 metal, antracyt lub tytanowy



Lichtfarbe einstellbar ·
 Adjustable light color



4 fach TOUCH ·
 4 level Touch function



42 | Anthrazit · anthracite



87 | titanfarbig · titanium-coloured

Pendelleuchte · Pendant

↔ 120 x 15 cm, ↑ 150 cm
 incl. SMD-LED, 35 W
 3.700 lm, 2.700 + 3.800 + 5.000 K



371710142
 371710187



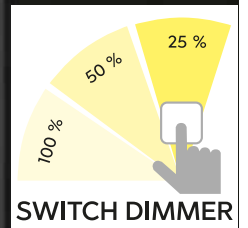

TUBULAR

Metall, Weiß matt oder Schwarz matt · metal, white mat or black mat ·
 metale, blanc mat ou noir mat · metaal, wit mat of mat zwart ·
 metal, estera blanca o estera negra · metallo, bianco opaco o nero opaco ·
 metal, alb mat sau negru mat · metalli, valkoinen matto tai musta matto ·
 metal, biały mat lub czarny mat



31 | Weiß matt · white mat

32 | Schwarz matt · black mat



Pendelleuchte · Pendant
 Ø 40 cm, ↓ 150 cm
 incl. 11 x SMD-LED, 2,5 W
 11 x 220 lm, 3.000 K



321691131
321691132

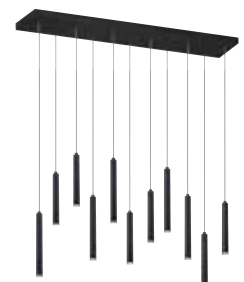

Pendelleuchte · Pendant
 ↔ 115 x 15 cm, ↓ 150 cm
 incl. 11 x SMD-LED, 2,5 W
 11 x 220 lm, 3.000 K



321611131
321611132





Empfohlen:
recommended: Filament LED E27, 6 W
600 lm, 3.000 K



988-600

Filament LED E27, 6 W
420 lm, 2.700 K



988-679

Filament LED E27, 6 W
190 lm, 3.000 K



988-654



Pendelleuchte · Pendant
↑ 150 cm, Ø 10 cm
excl. 1 x E27, max. 10 W



313400107
313400131
313400132



Pendelleuchte · Pendant
↔ 70 x 9 cm, ↓ 150 cm
excl. 4 x E27, max. 10 W



313400407
313400431
313400432



CLERMONT

Metall · metal ·
metale · metaal · metal · metallo · metal · metalli · metal



07 | Nickel matt · nickel mat

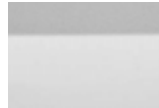

31 | Weiß matt · white mat



32 | Schwarz matt · black mat

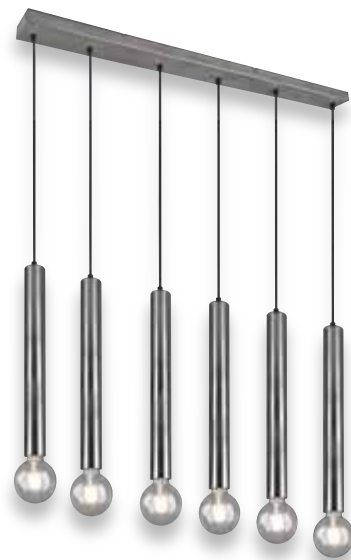

Pendelleuchte · Pendant
↔ 110 x 9 cm, ↓ 150 cm
excl. 6 x E27, max. 10 W



313400607
313400631
313400632



MARLEY

Metall · metal ·
metale · metaal · metal · metallo ·
metal · metalli · metal · metal

Empfohlen:
recommended: LED GU10, 5 W
400 lm, 3.000 K



956-55



01 | Weiß ·
white



07 | Nickel matt ·
nickel mat



24 | rostfarbig ·
rusty



32 | Schwarz matt ·
black mat



Pendelleuchte · Pendant
↑ 150 cm, ↔ 12 x 12 cm, Ø 6 cm
excl. 1 x GU10, max. 35 W



312400101
312400107
312400124
312400132

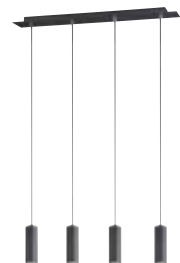

Pendelleuchte · Pendant
↔ 75 x 9 cm, ↓ 150 cm
excl. 4 x GU10, max. 35 W



312400401
312400407
312400424
312400432





BOOLAN

Holz · wood ·
bois · hout · madera · di legno ·
lemn · puu · drewno

Pendelleuchte · Pendant
Ø 50 cm, † 150 cm
excl. 1 x E27, max. 60 W



305900126
305900130



26 | Braun · brown



30 | holzfarbig hell · light colored wood

Empfohlen:
recommended: Filament LED E27, 6 W
600 lm, 3.000 K



988-600





MINSK

Metall, Acryl · metal, acryl ·
 metale, acryl · metaal, acryl · metal, acrílico ·
 metallo, acrilico · metal, acrilic · metalli, akryyli · metal, akryl

Empfohlen:
 recommended: Filament LED E14, 4,5 W
 470 lm, 2.700 K



989-400

Pendelleuchte · Pendant
 Ø 50 cm, ↓ max. 150 cm
 excl. 7 x E14, max. 28 W



308600706



CANDELA

Aluminium gebürstet/Chrom oder Messing matt/Messing poliert · brushed aluminium/chrome or brass mat/polished brass ·
 aluminium balayé/chrome ou laiton mat/laiton polis · geborsteld aluminium/chroom of messing mat/gepolijst messing ·
 aluminio pulido/cromo o bronce mate/bronce · alluminio spazzolato/cromo o ottone satinato/ottone lucido ·
 aluminiu lucios/crom sau bronz mat/bronz · harjattu alumiini/kromi tai mattamessinki/messinki ·
 aluminium szczotkowane/chrom lub mosiądz mat/mosiądz polerowany

Empfohlen:
 recommended: Filament LED E14, 4 W
 400 lm, 2.700 K



989-479



03 | Messing poliert · polished brass



05 | Aluminium gebürstet · brushed aluminium

Pendelleuchte · Pendant
 Ø 56 cm, ↑ 150 cm
 excl. 4 x E14, max. 40 W



102000403
 102000405





ELSA

Metall, Acryl · metal, acryl ·
metale, acryl · metaal, acryl · metal, acrílico ·
metallo, acrilico · metal, acrilic · metalli, akryyli · metal, akryl

Empfohlen:
recommended: Filament LED E14, 4 W
470 lm, 3.000 K



990-400



31 | Weiß matt · white mat

42 | Anthrazit · anthracite



Krone · Chandelier
Ø 56 cm, †150 cm
excl. 5 x E14, max. 40 W



112900531
112900542



Krone · Chandelier
Ø 72 cm, †150 cm
excl. 9 x E14, max. 40 W



112900931
112900942



LUCERNA

Chrom, Acryl · chrome, acryl ·
 chrome, acryl · chrom, acryl · cromo, acrílico · cromo, acrílico ·
 crom, acrílic · kromi, akryyli · chrom, akryl



Wandleuchte · Wall lamp
 ↔ 33 x 22 cm, ↗ 19 cm
 excl. 2 x E14, max. 40 W



201600206



Lüster · Chandelier
 Ø 52 cm, ↑ 150 cm
 excl. 5 x E14, max. 40 W



101600506



Lüster · Chandelier
 Ø 68,5 cm, ↑ 150 cm
 excl. 8 x E14, max. 40 W



101600806

Empfohlen:
 recommended: Filament LED E14, 4 W
 470 lm, 3.000 K



990-400





CORTEZ

Metall, Stoffschirm · metal, fabric shade ·
 metale, abat-jour tissu · metaal, Stoffen kap · metal, Pantalla de tela ·
 metallo, paralume in tessuto · metal, abajur textil · metalli, kangas varjostin ·
 metal, Klosz z materiału



31 | Weiß matt · white mat



78 | betonfarbig · concrete look



Pendelleuchte · Pendant
 Ø 52 cm, ↑ 150 cm
 excl. 3 x E14, max. 28 W



110600331
 110600378



Pendelleuchte · Pendant
 Ø 70 cm, ↑ 150 cm
 excl. 5 x E14, max. 28 W



110600531
 110600578



LORELEY

Chrom, Acryl, Stoffschild · chrome, acryl, fabric shade ·
 chrome, acryl, abat-jour tissu · chrom, acryl, Stoffen kap ·
 cromo, acrílico, Pantalla de tela · cromo, acrílico, paralume in tessuto ·
 crom, acrílic, abajur textil · kromi, akryyli, kangas varjostin ·
 chrom, akryl, Klosz z materiału

Pendelleuchte · Pendant

Ø 50 cm, † 150 cm

excl. 3 x E14, max. 40 W



309300301 | Weiß · white

309300302 | Schwarz · black





CHIRON

Aluminium, Messing matt, Schwarz matt · aluminium, brass mat, black mat ·
 aluminium, laiton mat, noir mat · aluminium, messing mat, mat zwart ·
 aluminio, bronce mate, estera negra · alluminio, ottone satinato, nero opaco ·
 aluminium, bronz mat, negru mat · alumiini, mattamessinki, mattamusta ·
 aluminium, mosiądz mat, czarny mat



Pendelleuchte · Pendant
 ↓ 150 cm, Ø 20 cm
 excl. 1 x E27, max. 40 W



310800108

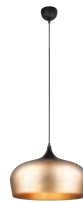

Pendelleuchte · Pendant
 ↓ 150 cm, Ø 45 cm
 excl. 1 x E27, max. 40 W



310890108



Pendelleuchte · Pendant
 ↔ 90 x 20 cm, ↓ 150 cm
 excl. 3 x E27, max. 40 W



310800308



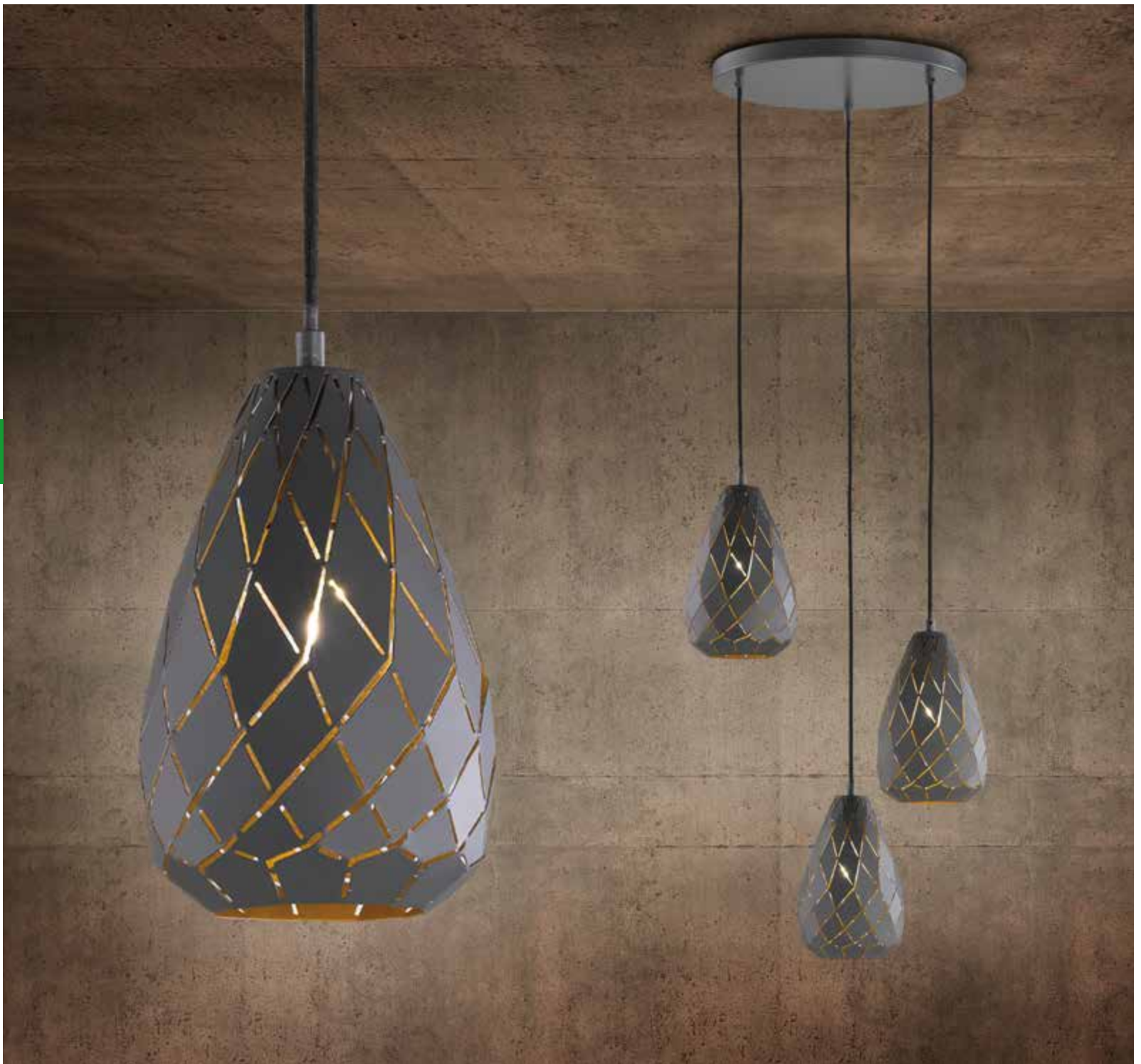

ONYX

Metall, Anthrazit, innen goldfarbig · metal, anthracite, gold colored inside ·
 metale, antracite, Or · metaal, antraciet, Binnenkant goudkleur ·
 metal, antracita, Interior en color dorado ·
 metallo, antracite, interno colore oro ·
 metal, antracit, interior culoare aurie ·
 metalli, antrasiitti, sisäosa kullanvärinen ·
 metal, antracyt, wewnątrz złoty



Pendelleuchte · Pendant
 Ø 15 cm, ↓ 150 cm
 excl. 1 x E27, max. 42 W



301300142



Pendelleuchte · Pendant
 Ø 35 cm, ↓ 150 cm
 excl. 3 x E27, max. 42 W



301300342



Pendelleuchte · Pendant
 ↔ 90 x 15 cm, ↓ 150 cm
 excl. 4 x E27, max. 42 W



301300442



HOLLY

Metall, Weiß matt · metal, white mat ·
metale, blanc mat · metaal, wit mat · metal, estera blanca ·
metallo, bianco opaco · metal, alb mat · metalli, mattavalkoinen ·
metal, biały mat



Pendelleuchte · Pendant
Ø 48 cm, ↓ 150 cm
excl. 3 x E27, max. 42 W



307400331

Empfohlen:
recommended: LED E27, 6 W
470 lm, 3.000 K



987-60



CAPITAL

Metall, Chrom · metal, chrome ·
metale, chrome · metaal, chroom · metal, cromo ·
metallo, cromo · metal, crom · metalli, kromi · metal, chrom



Pendelleuchte · Pendant
↓ 130 cm, Ø 40 cm
excl. 2 x E14, max. 40 W



308400206





BOSTON

Nickel matt · nickel mat ·
 nickel mat · nikkell mat · níquel mate · nichel opaco ·
 nichel mat · harjattu teräs · nikiel mat



Pendelleuchte · Pendant
 Ø 39 cm, ↑ 160 cm
 excl. 1 x E27, max. 60 W



301800107

ROMINO II

Schwarz matt, Metall · black mat, metal ·
noir mat, metale · mat zwart, metaal ·
estera negra, metal · nero opaco, metallo ·
negru mat, metal · musta matto, metalli ·
czarny mat, metal

Pendelleuchte · Pendant

Ø 50 cm, ↑ 150 cm

excl. 1 x E27, max. 60 W



308000132



238

OTTAWA

Metall goldfarbig · metal gold ·
metale or · metaal goud · metal oro · metallo oro ·
metal aur · metalli kultaa · metal złota

Pendelleuchte · Pendant

Ø 50 cm, ↑ 150 cm

excl. 1 x E27, max. 60 W



305700179





RAMIRO

Schwarz matt, goldfarbig · black mat, gold ·
noir mat, or · mat zwart, goud · estera negra, oro ·
nero opaco, oro · negru mat, aur · musta matto, kultaa ·
czarny mat, złota



Dimmbar ·
Dimmable



Pendelleuchte · Pendant
↔ 100 x 8,5 cm, ↓ 150 cm
incl. 4 x SMD-LED, 4,5 W
4 x 430 lm, 3.000 K



376410402



MIDAS

Chrom, Rauchglas · chrome, smoked glass ·
 chrome, verre fumé · chroom, rookglas · cromo, vidrio ahumado ·
 cromo, vetro fumé · crom, sticla fumurie · kromi, savulasi · chrom, szkło przydymione



Pendelleuchte · Pendant
 Ø 30 cm, ↑ 150 cm
 excl. 1 x E27, max. 40 W



301600106



Pendelleuchte · Pendant
 Ø 45 cm, ↑ 150 cm
 excl. 1 x E27, max. 40 W



301690106

Empfohlen:
 recommended: Filament LED E27, 4,5 W
 470 lm, 2.700 K



987-400

Filament LED E27, 6 W
 600 lm, 3.000 K



988-600



CALAIS

Rauchglas · smoked glass ·
 verre fumé · rookglas · vidrio ahumado ·
 vetro fumé · sticla fumurie · savulasi · szkło przydymione

Empfohlen:
 recommended: Filament LED E27, 4,5 W
 470 lm, 2.700 K



987-400



Pendelleuchte · Pendant
 ↓ 130 cm, Ø 20 cm
 excl. 1 x E27, max. 60 W



304800142

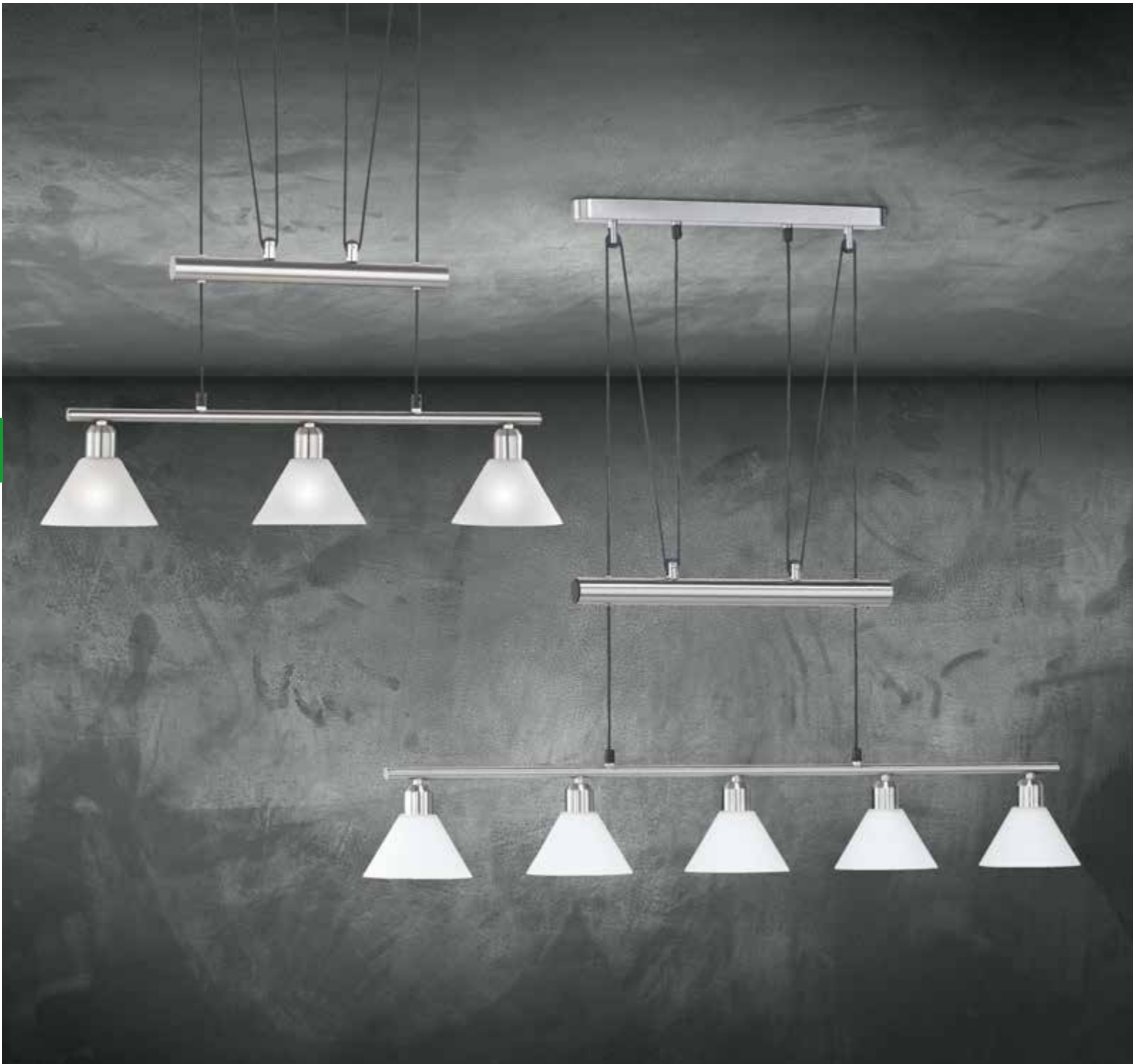

STAMINA

Nickel matt, Glas matt · nickel mat, mat glass ·
 nickel mat, verre mat · nikkel mat, mat glas ·
 níquel mate, vidrio mate · nichel opaco, vetro sabbiato ·
 nichel mat, sticla mata · harjattu teräs, mattalasi ·
 nikiel mat, szkło matowane

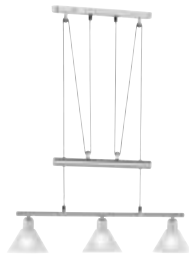

Pendelleuchte · Pendant
 ↔ 66 x 14 cm, ↓ 80 - 180 cm
 excl. 3 x E14, max. 40 W



3751031-07

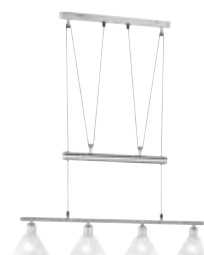

Pendelleuchte · Pendant
 ↔ 80 x 14 cm, ↓ 80 - 180 cm
 excl. 4 x E14, max. 40 W



3751041-07



Pendelleuchte · Pendant
 ↔ 102 x 14 cm, ↓ 80 - 180 cm
 excl. 5 x E14, max. 40 W



3751051-07



COLIN

Nickel matt, Glas matt · nickel mat, mat glass ·
 nickel mat, verre mat · nikkell mat, mat glas ·
 níquel mate, vidrio mate · nichel opaco, vetro sabbiato ·
 nichel mat, sticla mata · harjattu teräs, mattalasi ·
 nikiel mat, szkło matowane



Pendelleuchte · Pendant
 Ø 38,5 cm, ↓ 130 cm
 excl. 1 x E27, max. 60 W



3407011-07



VIOLA

Glas alabasterfarbig · alabaster-coloured glass ·
 verre couleur albâtre · albastkleurig glas · vidrio de color alabastro · vetro colore alabastro ·
 sticla culoare alabastru · lasi alabasteri väri · szkło alabaster kolor

Pendelleuchte · Pendant
 Ø 38,5 cm, ↑ 70 - 130 cm
 excl. 1 x E27, max. 60 W



301700107
 301700108



07 | Nickel matt · nickel mat

08 | Messing matt · brass mat



DIEGO

Kunststoff, Glas · plastic, glass ·
 plastique, verre · kunststof, glas · plástico, vidrio ·
 plastica, vetro · plastic, sticla · muovi, lasi · plastik, szkło



01 | Weiß · white

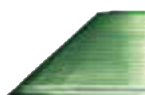

15 | Grün · green

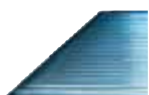

12 | Blau · blue



24 | Amber · amber

Pendelleuchte · Pendant
 Ø 30 cm, ↓ 125 cm
 excl. 1 x E27, max. 60 W



301400101
 301400112
 301400115
 301400124

BAJO

Metall weiß · metal white ·
metale blanc · metaal wit · metal blanco · metallo bianco ·
metal alb · metalli valkoinen · metal biały

Pendelleuchte · Pendant
Ø 32,5 cm, ↓ 150 cm
excl. 1 x E27, max. 40 W



307290101



246

ZUCCA

Chrom, Acryl · chrome, acryl ·
chrome, acryl · chroom, acryl · cromo, acrílico ·
cromo, acrilico · crom, acrilic · kromi, akryyli · chrom, akryl



00 | Transparent · transparent



06 | Chrom · chrome

Pendelleuchte · Pendant
Ø 40 cm, ↓ 150 cm
excl. 1 x E27, max. 60 W



304100100
304100106





PAPER

Papier, Weiß · paper, white ·
papier, blanc · papier, wit · papel, blanco ·
carta, bianco · hartie, alb · paperi, valkoinen · papier, biały



↓ 73,5 cm
excl. 1 x E27, max. 60 W
VE / moq: 25



3590010-01



Pendelleuchte · Pendant
Ø 40 cm
excl. 1 x E27, max. 60 W
VE / moq: 25



3490400-00



Pendelleuchte · Pendant
Ø 40 cm, ↓ 47 cm
excl. 1 x E27, max. 60 W
VE / moq: 25



3491400-00





248 - 303

Leuchten im Vintage Stil

Vintage style luminaires

Luminaire style Vintage

Armaturen in Vintage stijl

Lámparas vintage

Apparecchi stile vintage

Corpuri de iluminat vintage

Vintage valaisimet

Lampy w stylu vintage



BRAD

Nickel antik, Holz · nickel antique, wood ·
 nickel antique, bois · antiek nikkel, hout · níquel antiguo, madera ·
 nickel anticato, di legno · nichel antic , lemn · antiikkiteräs, puu ·
 aikiel antyczny, drewno · antik nikel, tahta

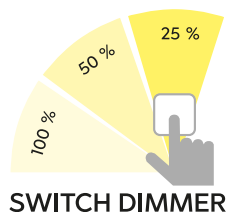

Wandleuchte · Wall lamp
 ↓ 11 x 11 cm, ↗ 11 cm
 incl. OSRAM-LED, 4,3 W
 430 lm, 3.000 K



223710130



Wandleuchte · Wall lamp
 ↓ 11 x 37 cm, ↗ 11 cm
 incl. SMD-LED, 13,5 W
 1.800 lm, 3.000 K



223790130



Deckenleuchte · Ceiling lamp
 ↔ 100 x 20 cm, ↑ 16,7 cm
 incl. SMD-LED, 27 W
 3.000 lm, 3.000 K



623710130



Pendelleuchte · Pendant
 ↔ 100 x 20 cm, ↓ 150 cm
 incl. SMD-LED, 27 W
 3.000 lm, 3.000 K



323710130



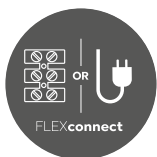
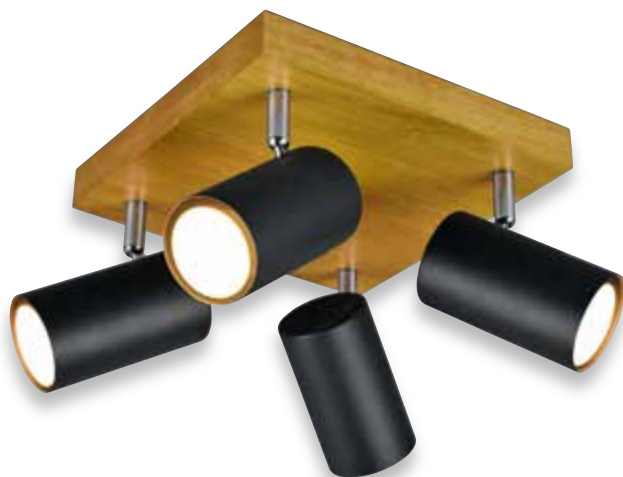
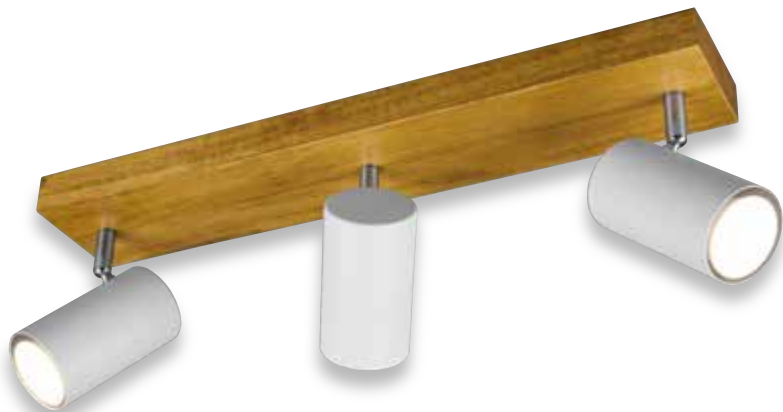

Seite/page 648



Wandleuchte · Wall lamp
 ↔ 12 x 9 cm, ↗ 16 cm
 excl. 1 x GU10, max. 15 W



812400107
 812400131
 812400132



Deckenleuchte · Ceiling lamp
 ↔ 26 x 9 cm, ↓ 16 cm
 excl. 2 x GU10, max. 35 W



812400207
 812400231
 812400232



Deckenleuchte · Ceiling lamp
 ↔ 44 x 9 cm, ↓ 16 cm
 excl. 3 x GU10, max. 35 W



812400307
 812400331
 812400332



Deckenleuchte · Ceiling lamp
 ↔ 22 x 22 cm, ↓ 16 cm
 excl. 4 x GU10, max. 35 W



812400407
 812400431
 812400432

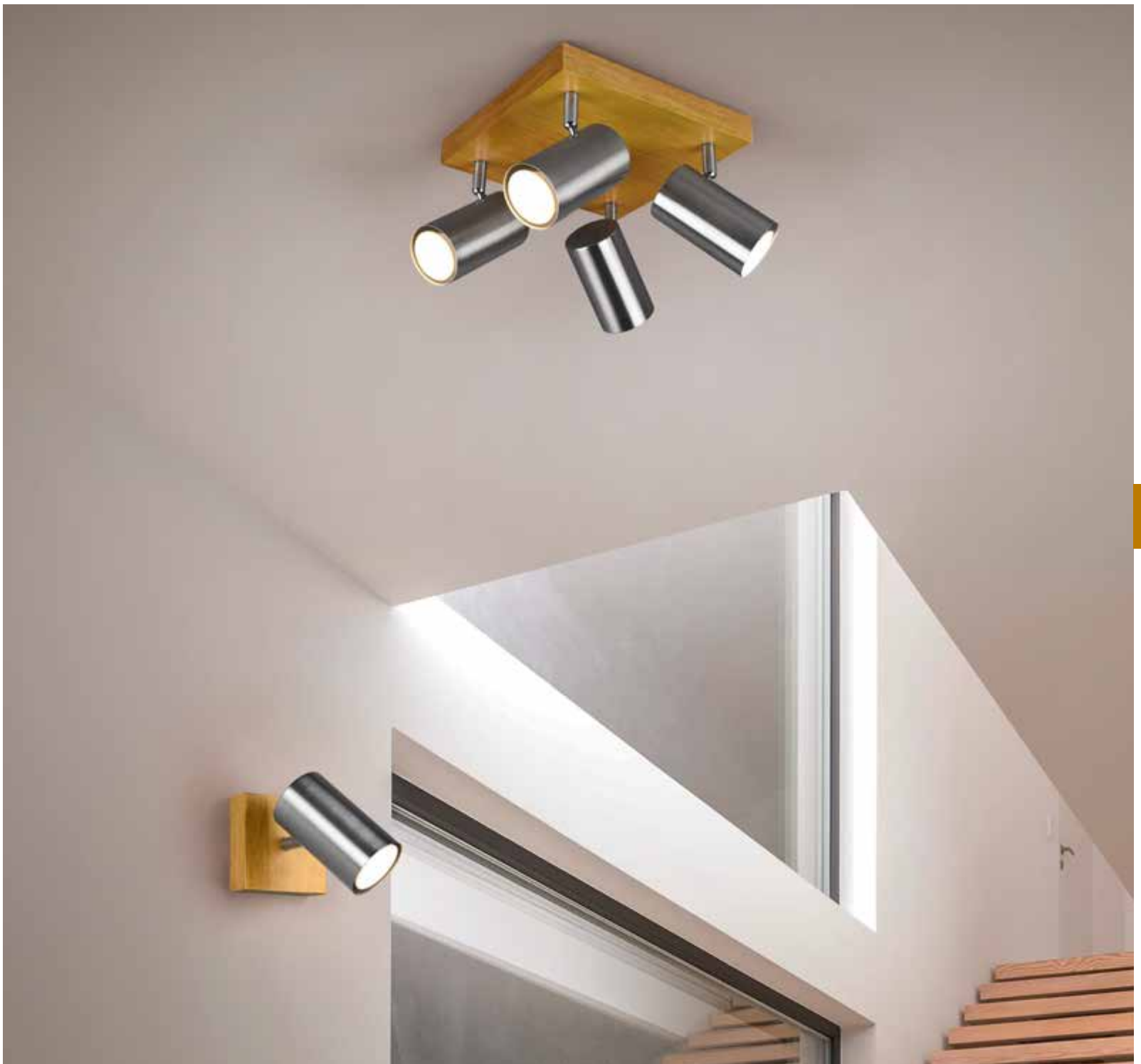

MARLEY

Metall, Holz · metal, wood ·
 metale, bois · metaal, hout · metal, madera ·
 metallo, di legno · metal, lemn · metalli, puu · metal, drewno

Empfohlen:
 recommended: LED GU10, 5 W
 400 lm, 3.000 K



956-55



07 | Nickel matt · nickel mat



31 | Weiß matt · white mat



32 | Schwarz matt · black mat



Wandleuchte · Wall lamp
 ↔ 12 x 12 cm, ȳ 10 cm
 incl. SMD-LED, 4,3 W
 400 lm, 3.000 K



224810131
 224810132
 224810167

ARINO

Metall, Holz · metal, wood ·
 metale, bois · metaal, hout · metal, madera ·
 metallo, di legno · metal, lemn · metalli, puu · metal, drewno

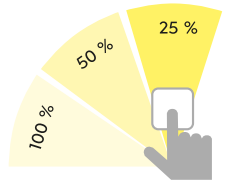

SWITCH DIMMER

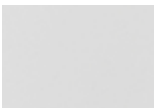

31 | Weiß matt · white mat

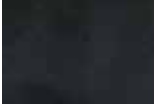

32 | Schwarz matt · black matt

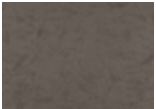

67 | Nickel antik · nickel antique



Wandleuchte · Wall lamp
 ↔ 35,2 x 12 cm, ȳ 10 cm
 incl. SMD-LED, 13,5 W
 1.500 lm, 3.000 K



224819131
 224819132
 224819167





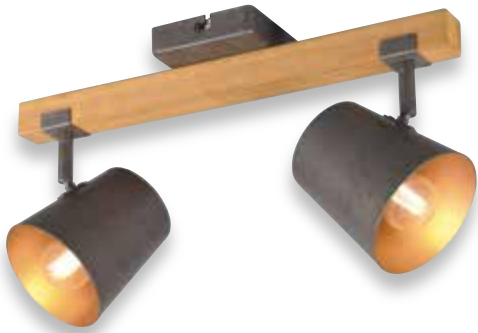

Deckenleuchte · Ceiling lamp
 ↔ 42,5 x 14,5 cm, ↓ 23,2 cm
 excl. 2 x E14, max. 25 W



801900267



Deckenleuchte · Ceiling lamp
 ↔ 58 x 10 cm, ↓ 23 cm
 excl. 3 x E14, max. 25 W



801900367



Wandleuchte · Wall lamp
 ↔ 11 x 11 cm, ↓ 23,2 cm
 excl. 1 x E14, max. 25 W



801900167



Deckenleuchte · Ceiling lamp
 ↔ 39 x 39 cm, ↓ 19,8 cm
 excl. 4 x E14, max. 25 W



601900467



Stehleuchte · Floor lamp
 ↓ 150 cm, ↔ 25 x 25 cm
 excl. 3 x E14, max. 25 W



401900367

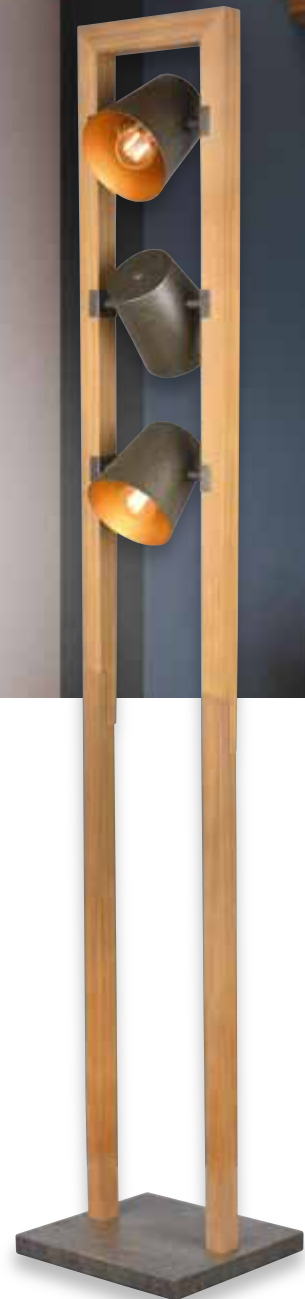



BELL

Metall, Nickel antik, innen goldfarbig, Holz · metal, nickel antique, gold colored inside, wood ·
 metale, nickel antique, Or, bois · metaal, antiek nikkel, Binnenkant goudkleur, hout ·
 metal, níquel antiguo, Interior en color dorado, madera · metallo, nickel anticato,
 interno colore oro, di legno · metal, nichel antic, interior culoare aurie, lemn ·
 metalli, antiikkiteräs, sisäosa kullanvärinen, puu · metal, aikiel antyczny, wewnątrz złoty, drewno

Empfohlen:
 recommended: Filament LED E14, 4 W
 470 lm, 3.000 K



983-400

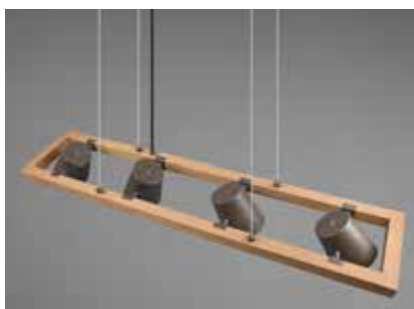

Pendelleuchte · Pendant
 ↔ 100 x 21 cm, ↓ 150 cm
 excl. 4 x E14, max. 25 W



301900467



HARRIS

Metall, Schwarz matt, innen goldfarbig, Holz · metal, black mat, gold colored inside, wood ·
 metale, noir mat, Or, bois · metaal, mat zwart, Binnenkant goudkleur, hout ·
 metal, estera negra, Interior en color dorado, madera · metallo, nero opaco, interno colore oro, di legno ·
 metal, negru mat, interior culoare aurie, lemn · metalli, mattamusta, sisäosa kullanvärinen, puu ·
 metal, czarny mat, wewnątrz złoty, drewno



Pendelleuchte · Pendant
 ↓ 150 cm, Ø 26 cm
 excl. 1 x E27, max. 60 W



312700132



Pendelleuchte · Pendant
 ↓ 150 cm, ↔ 87 cm, Ø 18 cm
 excl. 4 x E27, max. 40 W



312700432



Stehleuchte · Floor lamp
 ↓ 156 cm, ↗ 75 cm, Ø 26 cm
 excl. 1 x E27, max. 60 W



412700132





HENLEY

Metall, Schwarz matt, Holz · metal, black mat, wood ·
 metale, noir mat, bois · metaal, mat zwart, hout · metal, estera negra, madera ·
 metallo, nero opaco, di legno · metal, negru mat, lemn · metalli, mattamusta, puu ·
 metal, czarny mat, drewno



Pendelleuchte · Pendant
 Ø 40 cm, ↓ 150 cm
 excl. 3 x E14, max. 40 W



310730332



Pendelleuchte · Pendant
 ↔ 115 x 18 cm, ↓ 150 cm
 excl. 4 x E14, max. 40 W



310700432



RODRIGO

Metall, Nickel antik, innen goldfarbig, Holz · metal, nickel antique, gold colored inside, wood ·
 metale, nickel antique, Or, bois · metaal, antiek nikkel, Binnenkant goudkleur, hout ·
 metal, níquel antiguo, Interior en color dorado, madera · metallo, nickel anticato, interno colore oro, di legno ·
 metal, nichel antic, interior culoare aurie, lemn · metalli, antiikkiteräs, sisäosa kullanvärinen, puu ·
 metal, aikiel antyczny, wewnątrz złoty, drewno



Stehleuchte · Floor lamp
 ↓ 165 cm, ↔ 26 cm, ↗ 41 cm
 excl. 1 x E27, max. 60 W



402690167



Pendelleuchte · Pendant

↔ 107,5 cm, ↓ max. 215 cm, Ø 25,5 cm
excl. 3 x E27, max. 42 W



303400367



Stehleuchte · Floor lamp

↓ 150 cm, Ø 25,5 cm, ∠ 21,5 cm
excl. 1 x E27, max. 42 W



403490167





DELHI

Metall, Nickel antik, Holz · metal, nickel antique, wood ·
 metale, nickel antique, bois · metaal, antiek nikkel, hout · metal, níquel antiguo, madera ·
 metallo, nickel anticato, di legno · metal, nichel antic, lemn · metalli, antiikkiteräs, puu ·
 metal, aikiel antyczny, drewno

Empfohlen:
 recommended: Filament LED E27, 4,5 W
 470 lm, 2.700 K



987-400



Pendelleuchte · Pendant
 Ø 45 cm, ↑ 150 cm
 excl. 1 x E27, max. 60 W



303400167



DELHI

Metall, Nickel antik, Holz · metal, nickel antique, wood ·
 metale, nickel antique, bois · metaal, antiek nikkel, hout · metal, níquel antiguo, madera ·
 metallo, nickel anticato, di legno · metal, nichel antic, lemn · metalli, antiikkiteräs, puu ·
 metal, aikiel antyczny, drewno



Deckenleuchte · Ceiling lamp
 Ø 11,6 cm, √ 20,5 cm
 excl. 1 x E14, max. 40 W



803400167



Deckenleuchte · Ceiling lamp
 ↔ 33 x 11,6 cm, ↓ 20,5 cm
 excl. 2 x E14, max. 40 W



803400267



Deckenleuchte · Ceiling lamp
 ↔ 58 x 11,6 cm, ↓ 20,5 cm
 excl. 3 x E14, max. 40 W



803400367



Deckenleuchte · Ceiling lamp
 ↑ 158 cm, ↔ 66 cm, Ø 40 cm
 excl. 1 x E27, max. 60 W



403400167



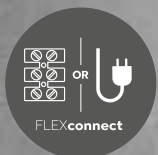

Seite/page 648



Wandleuchte · Wall lamp
 ↓ 32 cm, ↔ 15 cm, ↗ 25,6 cm
 excl. 1 x E14, max. 10 W



209500167



Pendelleuchte · Pendant
 Ø 35 cm, ↓ 150 cm
 excl. 1 x E27, max. 28 W



309500167

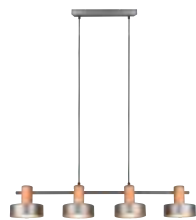

Pendelleuchte · Pendant
 ↔ 90 x 15 cm, ↓ 150 cm
 excl. 4 x E14, max. 28 W



309500467



Stehleuchte · Floor lamp
 ↓ 152 cm, ↗ 77 cm, Ø 35/25 cm
 excl. 1 x E27, max. 10 W



409500167



GAYA

Metall, Nickel antik, Holz · metal, nickel antique, wood ·
 metale, nickel antique, bois · metaal, antiek nikkell, hout · metal, níquel antiguo, madera ·
 metallo, nickel anticato, di legno · metal, nichel antic, lemn · metalli, antiikkiteräs, puu ·
 metal, aikiel antyczny, drewno · metal, antik nikel, tahta

Empfohlen:
 recommended: Filament LED E27, 4,5 W
 470 lm, 2.700 K



987-400



Filament LED E14, 4 W
 470 lm, 3.000 K

983-400



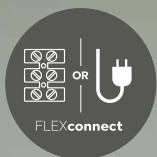

Seite/page 648



Deckenleuchte · Ceiling lamp
 ↔ 40 x 40 cm, ↓ 20 cm
 excl. 4 x E27, max. 28 W



605500467



Wandleuchte · Wall lamp
 ↓ 20 cm, ↔ 15 cm, ↗ 11 cm
 excl. 1 x E27, max. 28 W



205570167



Wandleuchte · Wall lamp
 ↓ 20 cm, ↔ 35 cm, ↗ 11 cm
 excl. 2 x E27, max. 28 W



205570267



KHAN

Nickel antik, Holz · nickel antique, wood ·
 nickel antique, bois · antiek nikkel, hout · níquel antiguo, madera ·
 nickel anticato, di legno · nichel antic , lemn · antiikkiteräs, puu ·
 aikiel antyczny, drewno · antik nikel, tahta

Empfohlen:
 recommended: Filament LED E27, 6 W
 600 lm, 2.700 K



987-679



Stehleuchte · Floor lamp
 ↓ 153 cm, ↔ 25 x 25 cm
 excl. 3 x E27, max. 10 W



405500367



Pendelleuchte · Pendant
 ↔ 100 x 15 cm, ↓ 150 cm
 excl. 4 x E27, max. 28 W



305500467



BRADLEY

Holz · wood ·
bois · hout · madera · di legno · lemn · puu · drewno

Empfohlen:
recommended: Filament LED E27, 6 W
600 lm, 2.700 K



987-679

Wandleuchte · Wall lamp
↓ 16 x 10,5 cm, ↗ 10,5 cm
excl. 2 x E27, max. 10 W



203000230



AGRA

Metall, Schwarz matt, Holz · metal, black mat, wood ·
 metale, noir mat, bois · metaal, mat zwart, hout · metal, estera negra, madera ·
 metallo, nero opaco, di legno · metal, negru mat, lemn · metalli, mattamusta, puu ·
 metal, czarny mat, drewno

Empfohlen:
 recommended: Filament LED E27, 4,5 W
 470 lm, 2.700 K



987-400

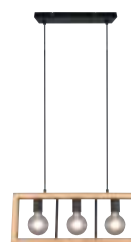

Pendelleuchte · Pendant
 ↔ 60 x 8,5 cm, ↓ 150 cm
 excl. 3 x E27, max. 10 W



313800332



Pendelleuchte · Pendant
 ↔ 100 x 8,5 cm, ↓ 150 cm
 excl. 5 x E27, max. 10 W



313800532

JANKO

Holz, Stoffschirm · wood, fabric shade ·
 bois, abat-jour tissu · hout, Stoffen kap ·
 madera, Pantalla de tela · di legno, paralume in tessuto ·
 lemn, abajur textil · puu, kangas varjostin ·
 drewno, Klosz z materiału



Tischleuchte · Table lamp
 ↑ 44 cm, ↔ 14 cm, √ 26 cm
 excl. 1 x E14, max. 40 W



507700114



Stehleuchte · Floor lamp
 ↑ 160 cm, ↔ 23 cm, √ 40 cm
 excl. 1 x E14, max. 40 W



407700114



HEDDA

Metall, Schwarz matt, Sisal · metal, black mat, Sisal ·
 metale, noir mat, Sisal · metaal, mat zwart, Sisal · metal, estera negra, Sisal ·
 metallo, nero opaco, Sisal · metal, negru mat, Sisal · metalli, mattamusta, Sisal ·
 metal, czarny mat, Sizat

Empfohlen:
 recommended: Filament LED E27, 4,5 W
 470 lm, 2.700 K



987-400



Deckenleuchte · Ceiling lamp
 Ø 52 cm, ↓ 28 cm
 excl. 2 x E27, max. 40 W



612300236



Pendelleuchte · Pendant
 Ø 52 cm, ↓ 150 cm
 excl. 1 x E27, max. 40 W



312300136



RUNA

Metall, Schwarz matt, Sisal · metal, black mat, Sisal ·
 metale, noir mat, Sisal · metaal, mat zwart, Sisal · metal, estera negra, Sisal · metallo, nero opaco, Sisal ·
 metal, negru mat, Sisal · metalli, mattamusta, Sisal · metal, czarny mat, Sizal



Pendelleuchte · Pendant
 Ø 25 cm, ↓ 150 cm
 excl. 1 x E27, max. 40 W



303000132



Pendelleuchte · Pendant
 Ø 35 cm, ↓ 150 cm
 excl. 1 x E27, max. 40 W



303090132



Pendelleuchte · Pendantp
 ↔ 90 x 35 cm, ↓ 150 cm
 excl. 2 x E27, max. 40 W



303000232



Stehleuchte · Floor lamp
 ↓ 150 cm, Ø 35 cm
 excl. 1 x E27, max. 40 W



403000132



JUDITH

Glas klar · clear glass ·
verre claire · helder glas ·
vidrio claro · vetro chiaro ·
sticla transparentă · kirkas lasi ·
przezroczyste szkło



Pendelleuchte · Pendant

Ø 24,5 cm, † 150 cm
excl. 1 x E27, max. 60 W



302900102

Empfohlen:

recommended: Filament LED E27, 6 W
420 lm, 2.700 K



987-679

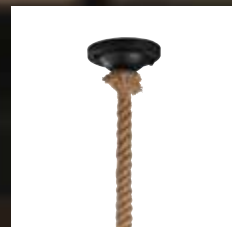

ROTIN

Rattangeflecht, Grau antik · rattan meshwork, antique grey ·
maillage rotin, gris ancien · rotan vlechtwerk, antiek grijs ·
malla de rattan, gris antiguo · reticolo rattan, grigio antico ·
impletitura ratan, antic gri · rottinki, antiikki harmaa ·
rattan, starodawny szary



Pendelleuchte · Pendant

Ø 39 cm, † 150 cm
excl. 1 x E27, max. 42 W



310900111

Empfohlen:

recommended: Filament LED E27, 6 W
600 lm, 3.000 K



988-600





ROPE

Metall, Altmessing · metal, old brass ·
 metale, laiton fumé · metaal, oud brons · metal, bronce viejo ·
 metallo, ottone invecchiato · metal, bronz antic · metalli, antiikkimessinki · metal, patyna

Empfohlen:

recommended: Filament LED E27, 6 W
 600 lm, 3.000 K



988-600

Filament LED E27, 6 W
 420 lm, 2.700 K



988-679



Pendelleuchte · Pendant
 Ø 12 cm, ↓ 150 cm
 excl. 1 x E27, max. 60 W



310100104



Pendelleuchte · Pendant
 Ø 12 cm, ↓ 150 cm
 excl. 2 x E27, max. 60 W



310100204



CORD

Metall, Stoffkabel · metal, fabric sheathed cable ·
 metale, câble gainé de tissu · metaal, kabel met stofmantel ·
 metal, cable forrado de tela · metallo, cavo rivestito in tessuto ·
 metal, țesătură din fibră de sticlă · metalli, kangaspäällysteinen
 kaapeli · metal, kabel z osłoną z tkaniny



Pendelleuchte · Pendant
 Ø 12 cm, ↓ 150 cm
 excl. 1 x E27, max. 60 W



310100106
 310100107
 310100108
 310100161
 310100162



Pendelleuchte · Pendant
 ↓ 150 cm, ↔ max. 180 cm
 excl. 5 x E27, max. 60 W



310100561
 310100562



06 | Chrom · chrome



07 | Nickel matt · nickel mat



08 | Messing matt · brass mat



61 | Grau antik · antique grey



62 | Kupfer antik · antique copper





Deckenleuchte · Ceiling lamp
 Ø 40 cm, ↓ 37 cm
 excl. 1 x E27, max. 60 W



601200101



Pendelleuchte · Pendant
 ↓ 150 cm, Ø 40 cm
 excl. 1 x E27, max. 60 W



301200101



Tischleuchte · Table lamp
 ↓ 34 cm, Ø 20 cm
 excl. 1 x E27, max. 60 W



501200101





KORBA

Holz, Stoffschirm · wood, fabric shade ·
 bois, abat-jour tissu · hout, Stoffen kap ·
 madera, Pantalla de tela · di legno, paralume in tessuto ·
 lemn, abajur textil · puu, kangas varjostin ·
 drewno, Klosz z materiału · tahta, Kumaş şapka



Pendelleuchte · Pendant
 ↓ 150 x 40 cm, ↔ 105 cm
 excl. 2 x E27, max. 60 W



301200201



Stehleuchte · Floor lamp
 ↓ 162 cm, Ø 40 cm
 excl. 1 x E27, max. 60 W



401200101



ELMAU

Holz, Stoffschirm · wood, fabric shade ·
bois, abat-jour tissu · hout, Stoffen kap · madera, Pantalla de tela ·
di legno, paralume in tessuto · lemn, abajur textil · puu, kangas varjostin · drewno, Klosz z materiału



Deckenleuchte · Ceiling lamp
Ø 35 cm, ↑ 36,5 cm
excl. 1 x E27, max. 60 W



602100130



Pendelleuchte · Pendant
Ø 35 cm, ↑ 150 cm
excl. 1 x E27, max. 60 W



302100130



Pendelleuchte · Pendant
↔ 100 x 20 cm, ↑ 150 cm
excl. 4 x E27, max. 60 W



302100430



Tischleuchte · Table lamp
↑ 40 cm, Ø 18 cm
excl. 1 x E14, max. 40 W



502100130







PLANT

Nickel antik, Sisal · nickel antique, Sisal ·
nickel antique, Sisal · antiek nikkel, Sisal ·
níquel antiguo, Sisal · nickel anticato, Sisal ·
nichel antic, Sisal · antiikkiteräs, Sisal ·
aikiel antyczny, Sizal

Deko-Pflanze nicht enthalten! · Decoration not included! ·
Décoration non incluse! · Decoratie niet inbegrepen! ·
Decoración no incluida. · Decorazione non inclusa! ·
Decorația nu este inclusă! · Koristus ei sisälly!
Nie zawiera dekoracji!

Empfohlen:
recommended: Filament LED E27, 4,5 W
470 lm, 2.700 K



987-400



92945



Pendelleuchte · Pendant
Ø 22 cm, ↓ 150 cm
excl. 1 x E27, max. 40 W



301000167



Pendelleuchte · Pendant
↔ 115 x 22 cm, ↓ 150 cm
excl. 3 x E27, max. 40 W



301000367



FORESTER

Metall, Nickel antik, Holz · metal, nickel antique, wood ·
 metale, nickel antique, bois · metaal, antiek nikkels, hout · metal, níquel antiguo, madera ·
 metallo, nickel anticato, di legno · metal, nichel antic, lemn · metalli, antiikkiteräs, puu ·
 metal, aikiel antyczn, drewno

Empfohlen:
 recommended: Filament LED E27, 4,5 W
 470 lm, 2.700 K



987-400



Pendelleuchte · Pendant
 ↔ 100 x 10 cm, ↓ 200 cm
 excl. 5 x E27, max. 42 W



308100567



Wandleuchte · Wall lamp
 ↓ 23 x 14 cm, ↗ 14 x 17 cm
 excl. 1 x E27, max. 28 W



805300188



Deckenleuchte · Ceiling lamp
 ↔ 30 x 14 cm, ↓ 28 cm
 excl. 2 x E27, max. 28 W



805300288



Deckenleuchte · Ceiling lamp
 ↔ 60,5 x 14 cm, ↓ 28 cm
 excl. 3 x E27, max. 28 W



805300388



Deckenleuchte · Ceiling lamp
 ↔ 80 x 14 cm, ↓ 28 cm
 excl. 4 x E27, max. 28 W



805300488



MADRAS

silberfarbig antik, Holz · antique silver, wood ·
 argent antique, bois · antiek zilver, hout · plateado antiguo, madera · argento anticato, di legno ·
 argint antic, lemn · antiikkihopea, puu · antyczne srebro, drewno · gümüş antika, tahta

Empfohlen:
 recommended: Filament LED E27, 8 W
 806 lm, 2.700 K



987-6810



Pendelleuchte · Pendant
 ↔ 90 x 14 cm, ↓ 150 cm
 excl. 4 x E27, max. 28 W



305300488



Pendelleuchte · Pendant
 Ø 25 cm, † 150 cm
 excl. 1 x E27, max. 40 W



309000167



Pendelleuchte · Pendant
 Ø 40 cm, † 150 cm
 excl. 1 x E27, max. 40 W



309090167



Stehleuchte · Floor lamp
 † 150 - 186 cm, Ø 69 cm
 excl. 1 x E27, max. 40 W



409000167





IVAR

Metall, Nickel antik, Holz · metal, nickel antique, wood ·
 metale, nickel antique, bois · metaal, antiek nikkell, hout ·
 metal, níquel antiguo, madera · metallo, nickel anticato, di legno ·
 metal, nichel antic, lemn · metalli, antiikkiteräs, puu ·
 metal, aikiel antyczny, drewno

Empfohlen:
 recommended: Filament LED E27, 6 W
 420 lm, 2.700 K



988-679



Pendelleuchte · Pendant
 ↔ 125 x 3 cm, ↓ 150 cm, Ø 40 cm
 excl. 2 x E27, max. 40 W



309000267



TOSH

Metall, Schwarz matt, Holz · metal, black mat, wood ·
 metale, noir mat, bois · metaal, mat zwart, hout · metal, estera negra, madera · metallo, nero opaco, di legno ·
 metal, negru mat, lemn · metalli, mattamusta, puu · metal, czarny mat, drewno



Pendelleuchte · Pendant
 Ø 10 cm, ↓ 150 cm
 excl. 1 x E27, max. 40 W



304300132



Pendelleuchte · Pendant
 Ø 28 cm, ↓ 150 cm
 excl. 3 x E27, max. 40 W



304330332



Pendelleuchte · Pendant
 ↔ 65 x 9 cm, ↓ 150 cm
 excl. 4 x E27, max. 40 W



304300432



Stehleuchte · Floor lamp
 ↓ 150 cm, Ø 23 cm
 excl. 3 x E14, max. 15 W



404300332





Wandleuchte · Wall lamp
 ↔ 9 x 13,7 cm, ↕ 19,5 cm
 excl. 1 x E14, max. 15 W



804370132



Deckenleuchte · Ceiling lamp
 ↔ 26 x 9 cm, ↕ 19,5 cm
 excl. 2 x E14, max. 15 W



804370232



Deckenleuchte · Ceiling lamp
 ↔ 44 x 9 cm, ↕ 19,5 cm
 excl. 3 x E14, max. 40 W



804300332



Deckenleuchte · Ceiling lamp
 ↔ 22 x 22 cm, ↕ 19,5 cm
 excl. 4 x E14, max. 40 W



804300432



TOSH

Metall, Schwarz matt, Holz · metal, black mat, wood ·
 metale, noir mat, bois · metaal, mat zwart, hout · metal, estera negra, madera ·
 metallo, nero opaco, di legno · metal, negru mat, lemn · metalli, mattamusta, puu ·
 metal, czarny mat, drewno

Empfohlen:
 recommended: Filament LED E14, 4 W
 470 lm, 3.000 K



983-400



Tischleuchte · Table lamp
 ↓ 40 cm, ↔ 15 x 18 cm
 excl. 1 x E14, max. 15 W



504300132



GOTHAM

Metall, Silber antik · metal, antique silver ·
 metale, argent antique · metaal, antiek zilver · metal, plateado antiguo ·
 metallo, argento anticato · metal, argint antic · metalli, antiikkihopea ·
 metal, antyczne srebro

Empfohlen:
 recommended: Filament LED E27, 6 W
 600 lm, 2.700 K



987-679



Wandleuchte · Wall lamp
 ↓ 46,5 x 14,6 cm, ↗ 17,3 cm
 excl. 1x E27, max. 60 W



207000188



Pendelleuchte · Pendant
 ↓ 150 cm, Ø 14,6 cm
 excl. 1 x E27, max. 60 W



307000188



Pendelleuchte · Pendant
 ↔ 102 x 46 cm, ↓ 150 cm
 excl. 6 x E27, max. 60 W



307000688



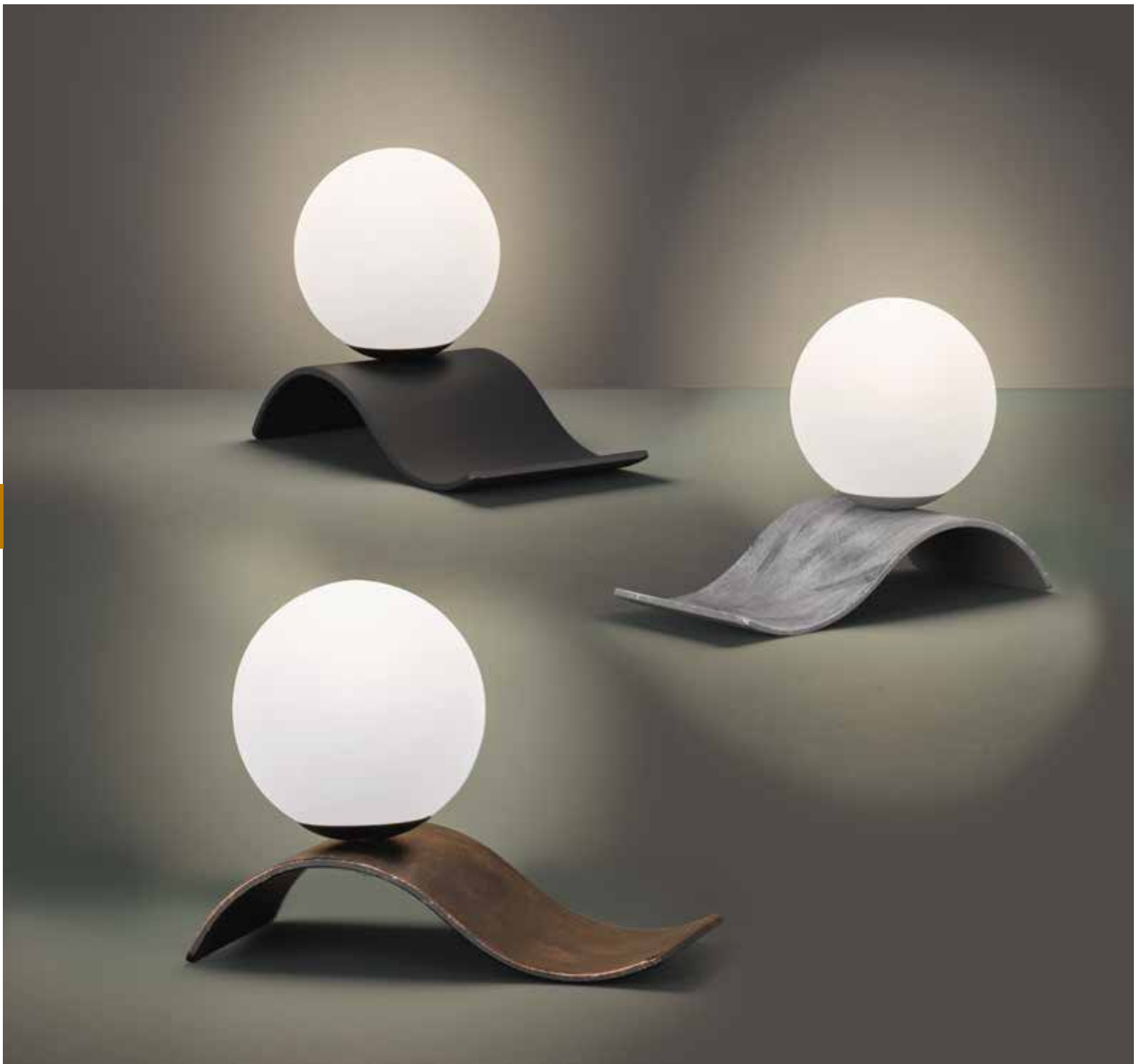

LARA

Metall, Glas matt · metal, mat glass ·
 metale, verre mat · metaal, mat glas · metal, vidrio mate ·
 metallo, vetro sabbato · metal, sticla mata · metalli, mattalasi ·
 metal, szkło matowane

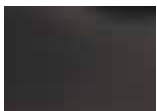

32 | Schwarz matt · black mat

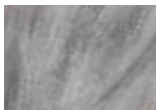

61 | Grau antik · antique grey

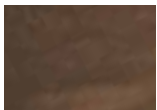

62 | Kupfer antik · antique copper

Tischleuchte · Table lamp
 ↔ 29 x 15 cm, ↓ 21 cm
 excl. 1 x E14, max. 40 W



508400132
 508400161
 508400162

NO. 5

Metall, Silber antik · metal, antique silver ·
metale, argent antique · metaal, antiek zilver ·
metal, plateado antiguo · metallo, argento anticato ·
metal, argint antic · metalli, antiikkihopea ·
metal, antyczne srebro



Stehleuchte · Floor lamp
↑ 134 cm, Ø 60 cm
excl. 1 x E27, max. 40 W



404200188



Deckenleuchte · Ceiling lamp
 Ø 30 cm, ↑ 18 cm
 excl. 1 x E27, max. 60 W



606903032
 606903062



Deckenleuchte · Ceiling lamp
 Ø 40 cm, ↑ 17 cm
 excl. 1 x E27, max. 60 W



606900132
 606900161
 606900162



Deckenleuchte · Ceiling lamp
 Ø 50 cm, ↑ 18 cm
 excl. 1 x E27, max. 60 W



606905032
 606905062

Empfohlen:
 recommended: Filament-LED E27, 4,5 W
 470 lm, 2.700 K



987-400



JOHANN

Metall, Grau antik oder Kupfer antik · metal, antique grey or antique copper ·
 metale, gris ancien ou cuivre ancien · metaal, antiek grijs of antiek koper · metal, gris antiguo o cobre antiguo ·
 metallo, grigio antico o rame antico · metal, antic gri sau cupru antic ·
 metalli, antiikki harmaa tai antiikki kupari · metal, starodawny szary lub antyczne miedzi



32 | Schwarz matt · black mat



61 | Grau antik · antique grey



62 | Kupfer antik · antique copper



SANNA

Metall · metal ·
metale · metaal · metal · metallo ·
metal · metalli · metal



Pendelleuchte · Pendant
Ø 25 cm, † 150 cm
excl. 1 x E27, max. 60 W



300900101
300900102

300



01 | Weiß · white



02 | Schwarz · black



TANJA

Metall, Schwarz · metal, black ·
metale, noir · metaal, zwart · metal, negro ·
metallo, nero · metal, negru · metalli, musta · metal, czarny



Pendelleuchte · Pendant
Ø 39 cm, † 150 cm
excl. 1 x E27, max. 60 W



300700102





JACOB

Metall, Grau antik oder Kupfer antik · metal, antique grey or antique copper ·
 metale, gris ancien ou cuivre ancien · metaal, antiek grijs of antiek koper ·
 metal, gris antiguo o cobre antiguo · metallo, grigio antico o rame antico ·
 metal, antic gri sau cupru antic · metalli, antiikki harmaa tai antiikki kupari ·
 metal, starodawny szary lub antyczne miedzi

Empfohlen:

recommended: Filament LED E27, 6 W
 600 lm, 3.000 K



988-600



61 | Grau antik · antique grey



62 | Kupfer antik · antique copper

Pendelleuchte · Pendant

Ø 40 cm, ↑ 150 cm
 excl. 1 x E27, max. 60 W



305100161
 305100162



JASMIN

Metall · metal ·
metale · metaal · metal · metallo ·
metal · metalli · metal

Pendelleuchte · Pendant
Ø 19 cm, ↑ 150 cm
excl. 1 x E14, max. 40 W



303700104
303700161
303700162



04 | Altmessing · old brass



61 | Grau antik · gray antique



62 | kupferfarbig antik · copper-coloured antique



FISHERMAN

Metall, Glas klar · metal, clear glass ·
 metale, verre claire · metaal, helder glas · metal, vidrio claro ·
 metallo, vetro chiaro · metal, sticlă transparentă · metalli, kirkas lasi · metal, przezroczyste szkło



04 | Altmessing · old brass



61 | Grau antik · gray antique



62 | kupferfarbig antik · copper-coloured antik

Empfohlen:
 recommended: Filament LED E27, 4,5 W
 470 lm, 2.700 K



987-400

Pendelleuchte · Pendant
 Ø 32 cm, ↑ 150 cm
 excl. 1 x E27, max. 28 W



304500104
304500161
304500162





304 - 429

Wand- & Deckenleuchten

Wall- & Ceiling lamps

Plafonniers & appliques

Wandlampen & plafonnières

Apliques y plafones

Applique e plafoniere

Plafoniere si aplice

Seinä- & katto

Sufitowe i ścienne



Getrennt schaltbar · Separately switchable
 Interrupteurs séparés · Gescheiden schakelbaar · Interruptores separados ·
 Interruttori separati · Intreruptoare separate · Erikseen kytkettävissä · Oddzileny przełącznik



1x

2x

3x





CHARLESTON

Metall, Aluminium gebürstet oder Anthrazit · metal, brushed aluminium or anthracite ·
 metale, aluminium balayé ou antracite · metaal, geborsteld aluminium of antraciet ·
 metal, aluminio pulido o antracita · metallo, alluminio spazzolato o antracite ·
 metal, aluminiu lucios sau antracit · metalli, harjattu alumiini tai antrasiitti ·
 metal, aluminium szczotkowane lub antracyt



Getrennt schaltbar ·
 Separately switchable



Memory Funktion ·
 Memory function



05 | Aluminium gebürstet · brushed aluminium

42 | Anthrazit · anthracite

Deckenleuchte · Ceiling lamp

↔ 101 x 38 cm, ↓ 12,5 cm

incl. SMD-LED, 21 W

2.600 lm, 3.000 K

incl. SMD-LED, 12 W

1.600 lm, 3.000 K



672110505

672110542

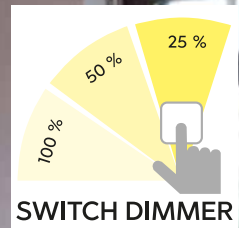

SWITCH DIMMER

TUCSON

Metall, Weiß matt oder Schwarz matt / Holznachbildung · metal, white mat or black mat / wood imitation ·
 metale, blanc mat ou noir mat / imitation bois · metaal, wit mat of mat zwart / houtimitatie · metal, estera blanca o estera negra / imitación de madera ·
 metallo, bianco opaco o nero opaco / effetto legno · metal, alb mat sau negru mat / imitație de lemn · metalli, mattavalkoinen tai mattamusta / puujäljitelmä ·
 metal, biały mat lub czarny mat / imitacja drewna



Deckenleuchte · Ceiling lamp

↔ 104 x 42 cm, ↑ 8,5 cm
 incl. SMD-LED, 35 W
 3.300 lm, 3.000 K



672610331 | Weiß matt · white mat

672610332 | Schwarz matt · black mat



IRVINE

Metall, Nickel matt, Weiß matt oder Anthrazit · metal, nickel mat, white mat or anthracite ·
 metale, nickel mat, blanc mat ou antracite · metaal, nikkel mat, wit mat of antraciet · metal, níquel mate, estera blanca o antracita ·
 metallo, nichel opaco, bianco opaco o antracite · metal, nichel mat, alb mat sau antracit · metalli, harjattu teräs, mattavalkoinen tai antrasiitti ·
 metal, nikiel mat, biały mat lub antracyt

 Lichtfarbe stufenlos einstellbar ·
 Light color infinitely variable

 Integrierter Dimmer ·
 Integrated dimmer

 Memory Funktion ·
 Memory function

 **07** | Nickel matt · nickel mat

 **31** | Weiß matt · white mat

 **42** | Anthrazit · anthracite

Deckenleuchte · Ceiling lamp

↔ 105 x 42 cm, ↑ 6,5 cm
 incl. SMD-LED, 60 W
 6.500 lm, 3.000-6.500 K



620010407
 620010431
 620010442

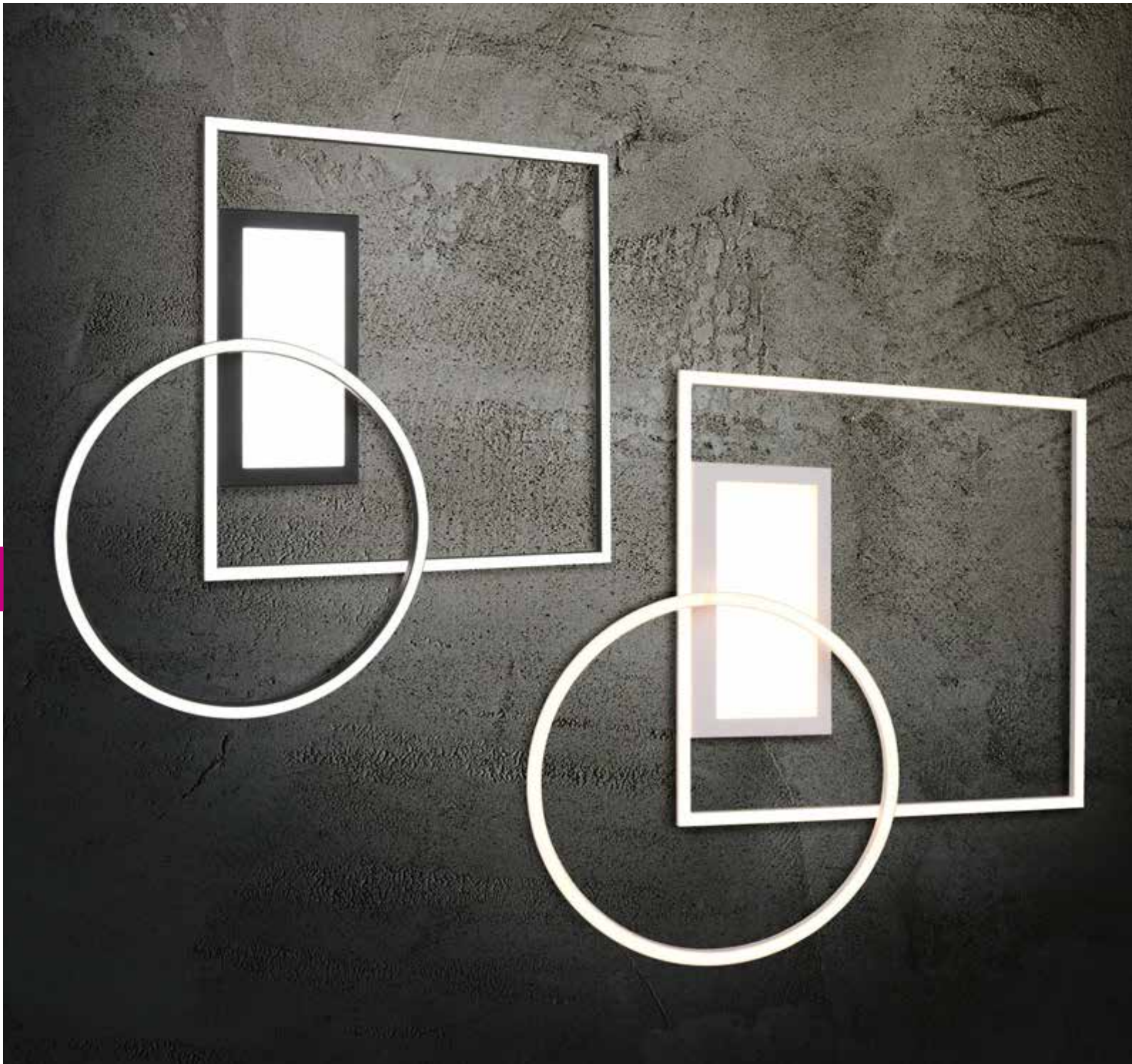

2.700 K

6.500 K



07 | Nickel matt · nickel mat



31 | Weiß matt · white mat



32 | Schwarz matt · black mat



DOWNEY

Metall, Acryl · metal, acryl ·
metale, acryl · metaal, acryl · metal, acrílico ·
metallo, acrilico · metal, acrylic · metalli, akryyli · metal, akryl



Lichtfarbe stufenlos einstellbar ·
Light color infinitely variable



Integrierter Dimmer ·
Integrated dimmer



Memory Funktion ·
Memory function

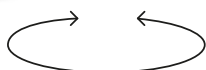

Schwenkbar · tiltable

Deckenleuchte · Ceiling lamp

↔ 64,5 x 86,5 cm, ↓ 89 cm
incl. SMD-LED, 33 W
4.600 lm, 2.700 - 6.500 K



620510307

620510331

620510332

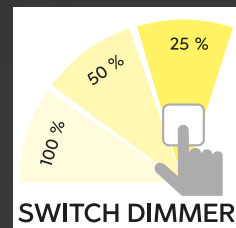

OXFORD

Metall, Nickel matt, Weiß matt oder Anthrazit · metal, nickel mat, white mat or anthracite ·
 metale, nickel mat, blanc mat ou antracite · metaal, nikkel mat, wit mat of antraciet ·
 metal, níquel mate, estera blanca o antracita · metallo, nichel opaco, bianco opaco o antracite ·
 metal, nichel mat, alb mat sau antracit · metalli, harjattu teräs, mattavalkoinen tai antrasiitti ·
 metal, nikiel mat, biały mat lub antracyt

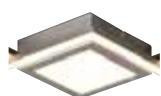

07 | Nickel matt · nickel mat



31 | Weiß matt · white mat

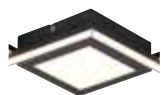

42 | Anthrazit · anthracite

Deckenleuchte · Ceiling lamp

↔ 102 x 78 cm, ↓ 5 cm
 incl. SMD-LED, 27 W
 3.000 lm, 3.000 K
 (31 = 3.300 lm, 4.000 K)



674410307
 674410331
 674410342

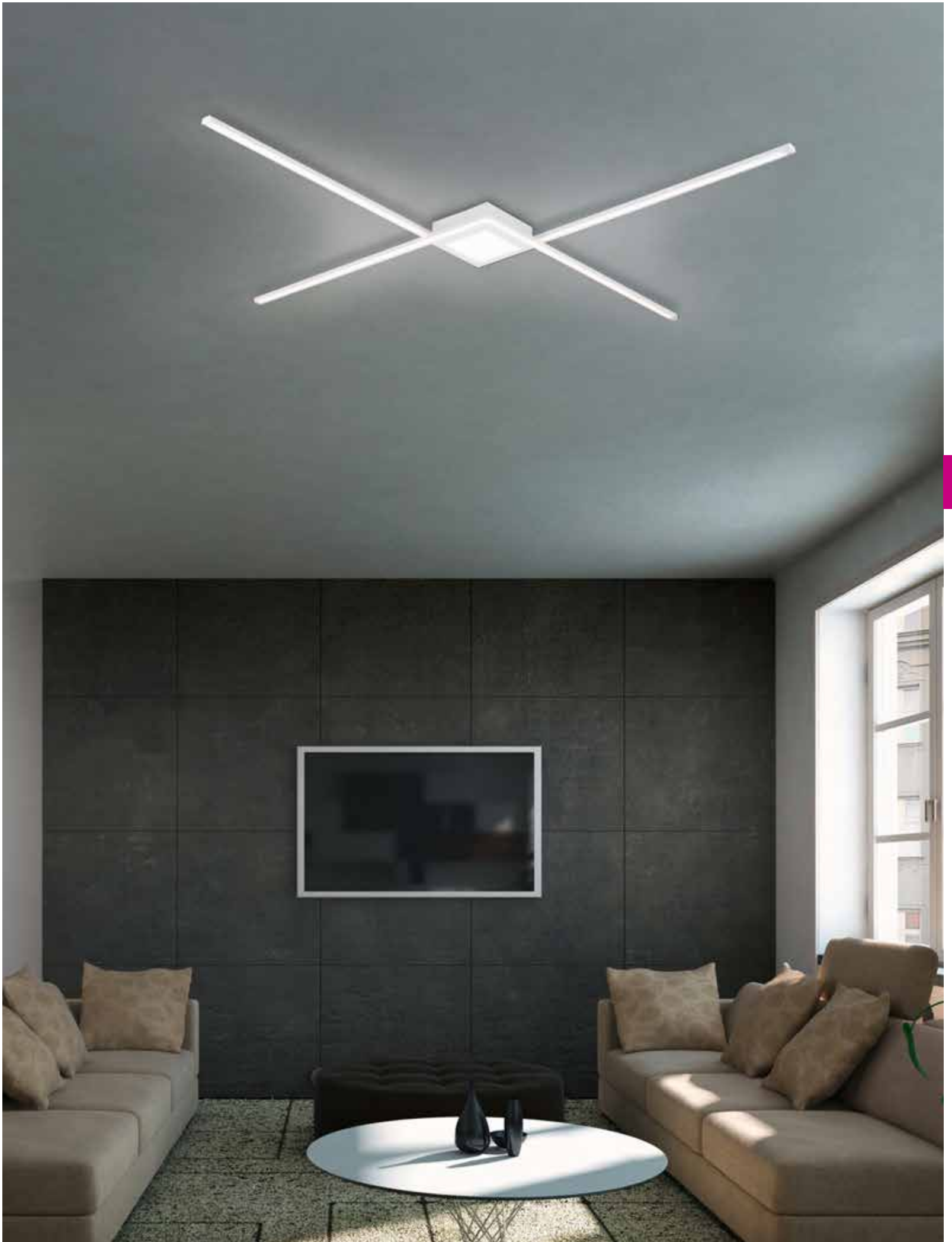

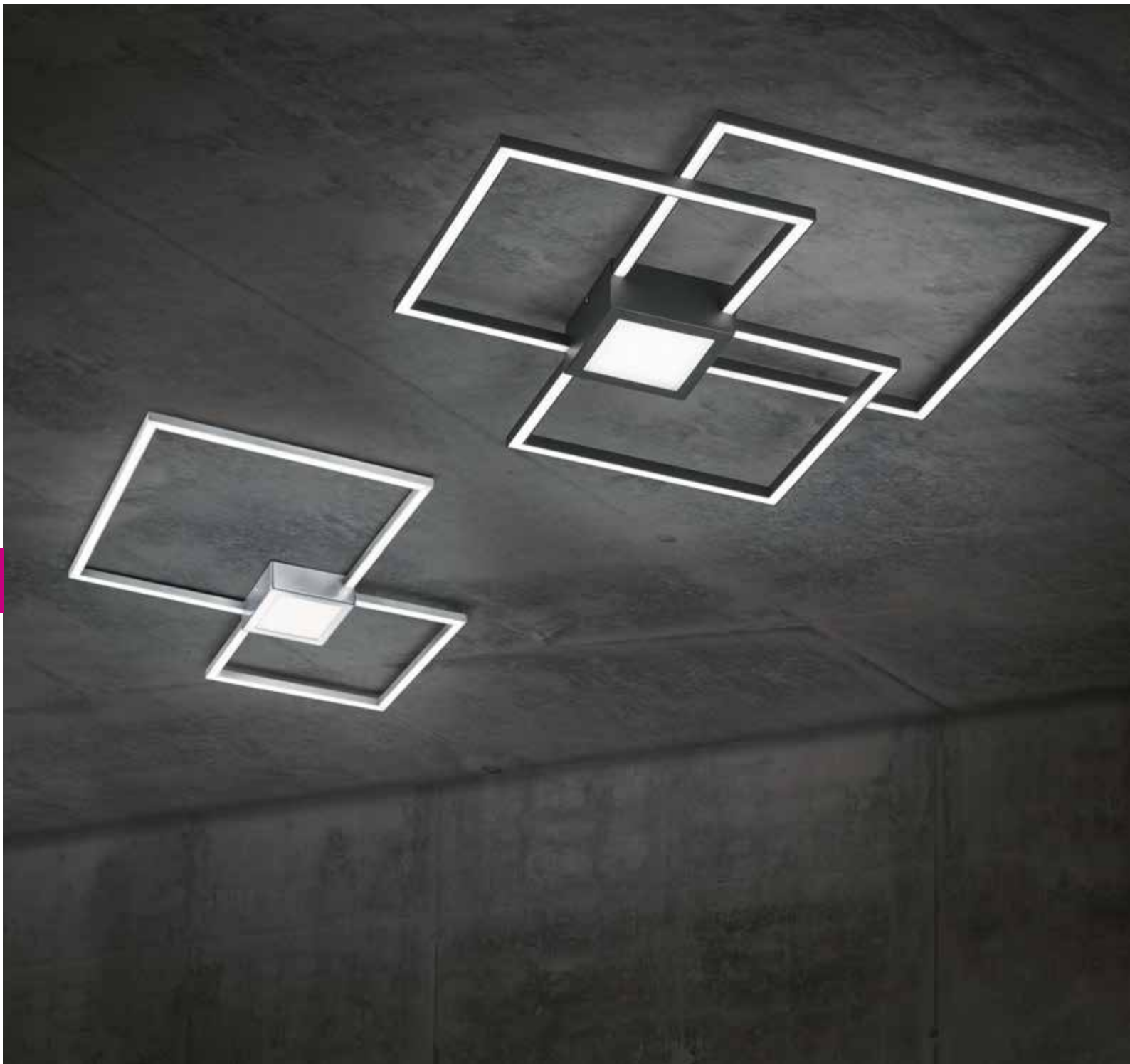

Deckenleuchte · Ceiling lamp
 ↔ 65 x 65 cm, ↑ 5 cm
 incl. SMD-LED, 28 W
 2.600 lm, 3.000 K



676210307
 676210342

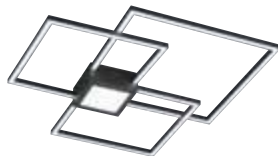

Deckenleuchte · Ceiling lamp
 ↔ 65,5 x 66,5 cm, ↑ 6,5 cm
 incl. SMD-LED, 38 W
 4.000 lm, 3.000 K



676210407
 676210442



07 | Nickel matt · nickel mat

42 | Anthrazit · anthracite



HYDRA

Nickel matt oder Anthrazit · nickel mat or anthracite ·
 nickel mat ou antracite · nikkel mat of antraciet · níquel mate o antracita ·
 nichel opaco o antracite · nichel mat sau antracit · harjattu teräs tai antrasiitti ·
 nikiel mat lub antracyt

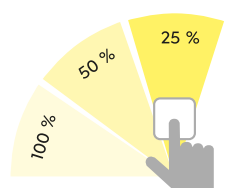

SWITCH DIMMER



Deckenleuchte · Ceiling lamp
 ↔ 80,5 x 45 cm, ↓ 5 cm
 incl. SMD-LED, 28 W
 2.600 lm, 3.000 K



676290307

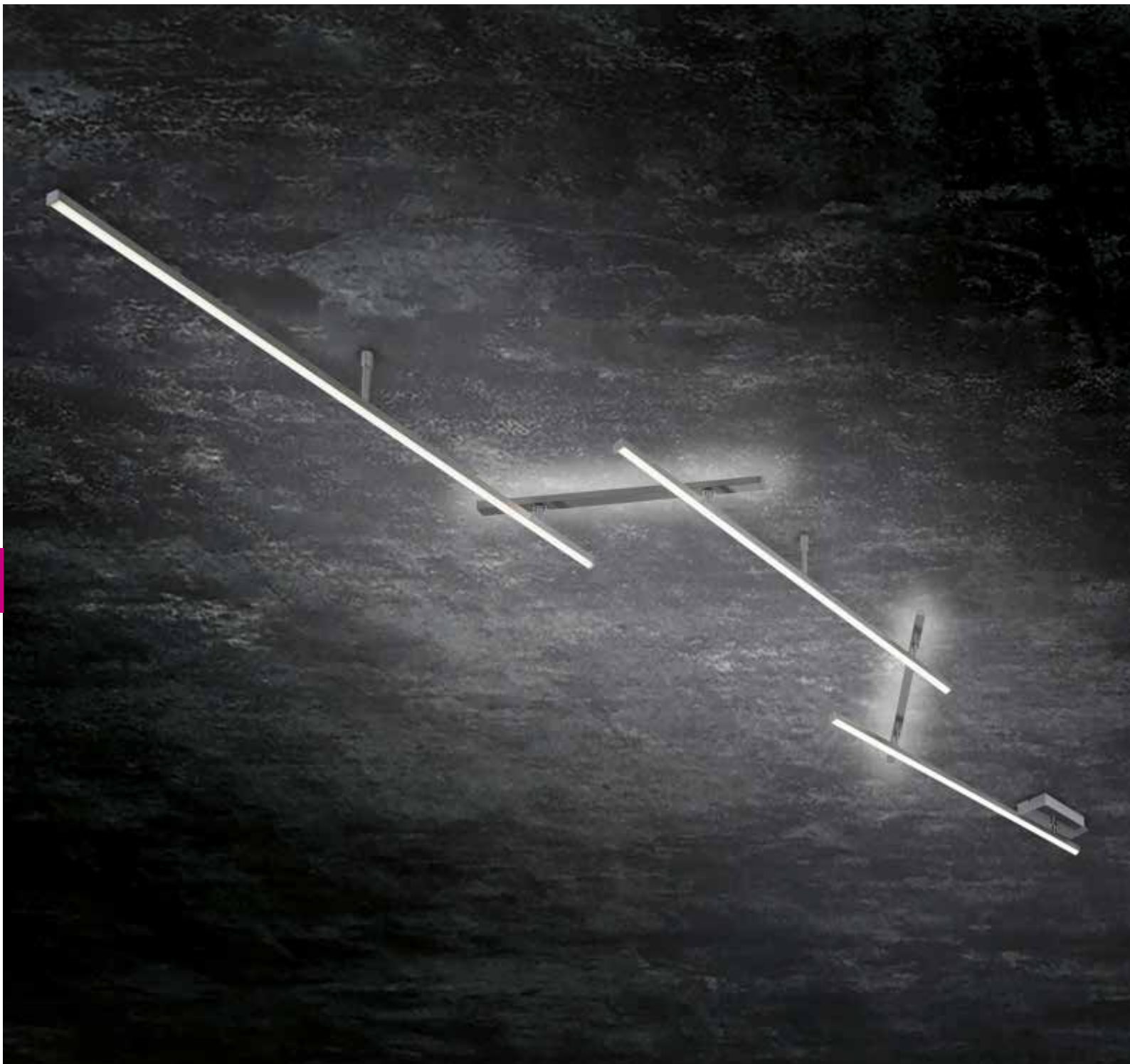

INDIRA

Metall, Nickel matt, Acryl · metal, nickel mat, acryl ·
 metale, nickel mat, acryl · metaal, nikkell mat, acryl · metal, níquel mate, acrílico ·
 metallo, nichel opaco, acrílico · metal, nichel mat, acrílico · metalli, harjattu teräs, akryyli ·
 metal, nikiel mat, akryl

Gibt Licht nach oben und unten · up and down lighting ·
 point lumineux en haut et en bas · lichtpunt boven en onder · luz de arriba y abajo ·
 luce su e giù · sus și în jos lumina · ylös ja alas valoa · w górę i w dół światło

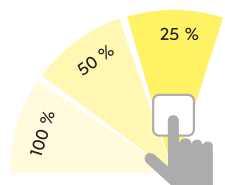

SWITCH DIMMER



Deckenleuchte · Ceiling lamp
 ↔ max. 245 cm, ↑ 6,5 cm
 incl. SMD-LED, 3 x 6 W
 3 x 650 lm, 3.000 K
 incl. SMD-LED, 2 x 3,5 W
 2 x 350 lm, 3.000 K



674610507



Deckenleuchte · Ceiling lamp
 ↔ max. 345 cm, ↑ 6,5 cm
 incl. SMD-LED, 20 W
 2.150 lm, 3.000 K
 incl. SMD-LED, 8 W
 850 lm, 3.000 K



674610707

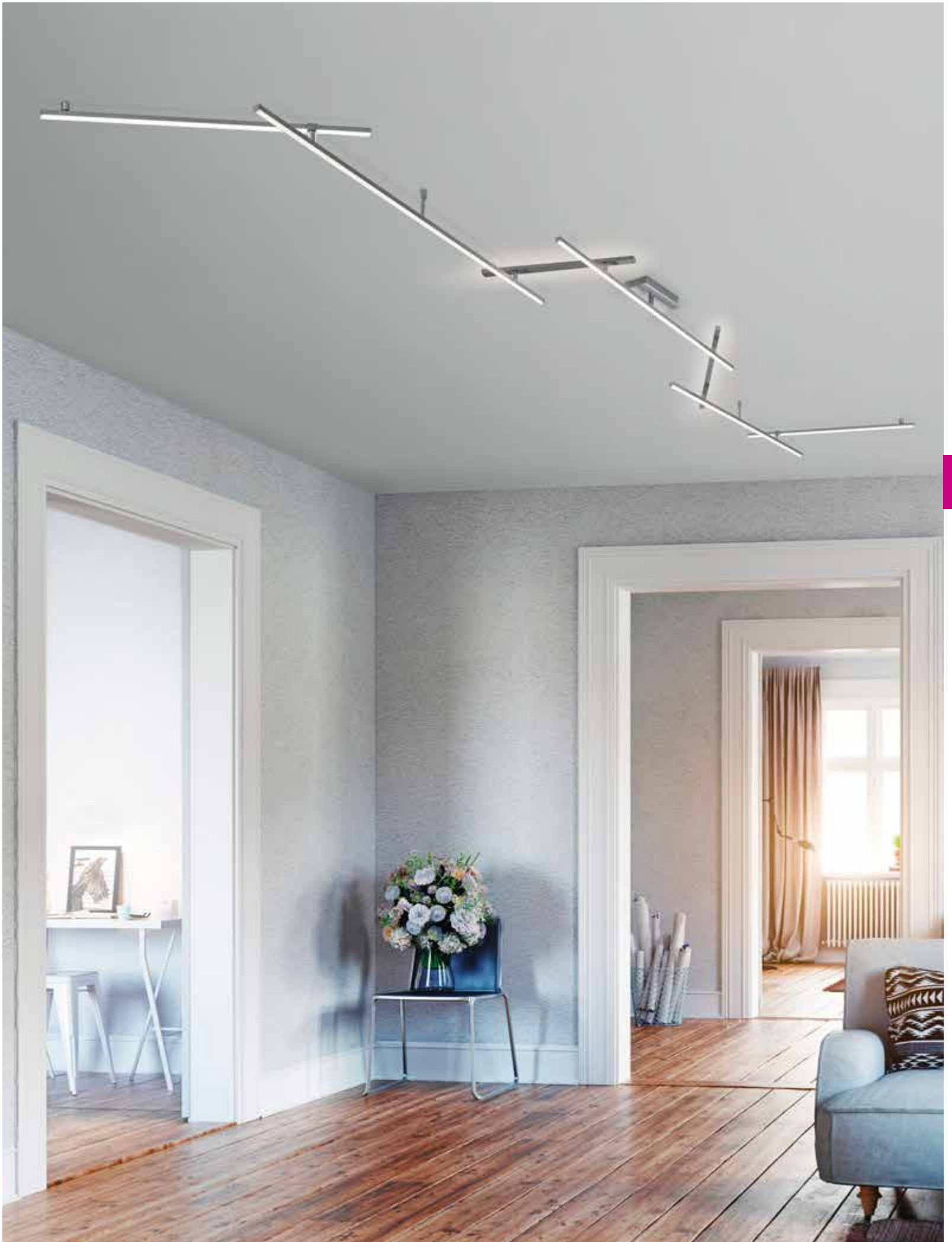



Gibt Licht nach oben und unten, getrennt schaltbar · up and down lighting, separately switchable ·
 point lumineux en haut et en bas, interrupteurs séparés · lichtpunt boven en onder, gescheiden schakelbaar ·
 luz de arriba y abajo, interruptores separados · luce su e giù, interruttori separati · sus și în jos lumina, intreruptoare separate ·
 ylös ja alas valoa, erikseen kytkettävissä · w górę iw dół światło, oddzielny przełącznik





ARVIN

Metall, Nickel matt oder Schwarz matt · metal, nickel mat or black mat ·
 metale, nickel mat ou noir mat · metaal, nikkel mat of mat zwart · metal, níquel mate o estera negra ·
 metallo, nichel opaco o nero opaco · metal, nichel mat sau negru mat · metalli, harjattu teräs tai mattamusta ·
 metal, nikiel mat lub czarny mat



RGBW Farbwechsler ·
 RGBW Colorchanging



Lichtfarbe stufenlos einstellbar ·
 Light color infinitely variable



Getrennt schaltbar ·
 Separately switchable



07 | Nickel matt · nickel mat



32 | Schwarz matt · black mat

Deckenleuchte · Ceiling lamp

↔ max. 245 x 50 cm, ↑ 8,5 cm
 incl. SMD-LED, 22 W
 2.600 lm, 2.700 - 6.500 K
 incl. RGB-LED, 8 W



628410507
 628410532



Gibt Licht nach oben und unten, getrennt schaltbar · up and down lighting, separately switchable ·
 point lumineux en haut et en bas, interrupteurs séparés · lichtpunt boven en onder, gescheiden schakelbaar ·
 luz de arriba y abajo, interruptores separados · luce su e giù, interruttori separati · sus și în jos lumina, intreruptoare separate ·
 ylös ja alas valoa, erikseen kytkettävissä · w górę iw dół światło, oddzielny przełącznik

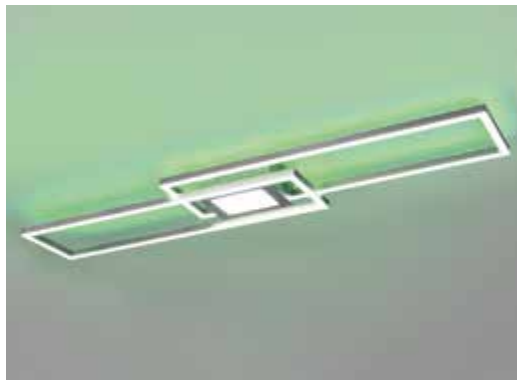
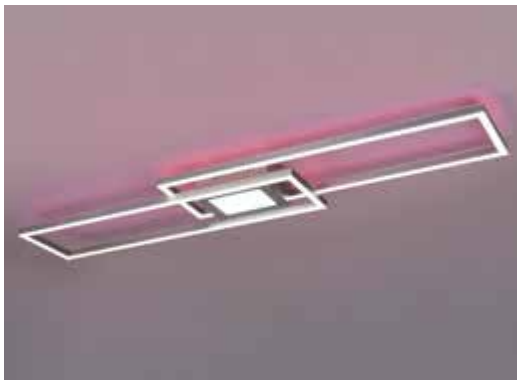



GANADO

Metall, Nickel matt oder Schwarz matt · metal, nickel mat or black mat ·
 metale, nickel mat ou noir mat · metaal, nikkell mat of mat zwart · metal, níquel mate o estera negra ·
 metallo, nichel opaco o nero opaco · metal, nichel mat sau negru mat · metalli, harjattu teräs tai mattamusta ·
 metal, nikiel mat lub czarny mat



RGBW Farbwechsler ·
 RGBW Colorchanging



Lichtfarbe stufenlos einstellbar ·
 Light color infinitely variable



Getrennt schaltbar ·
 Separately switchable



07 | Nickel matt · nickel mat



32 | Schwarz matt · black mat

Deckenleuchte · Ceiling lamp

↔ 110 x 21,2 cm, ↑ 7 cm
 incl. SMD-LED, 37 W
 4.300 lm, 2.700 - 6.500 K
 incl. RGB-LED, 8 W



670710507
 670710532

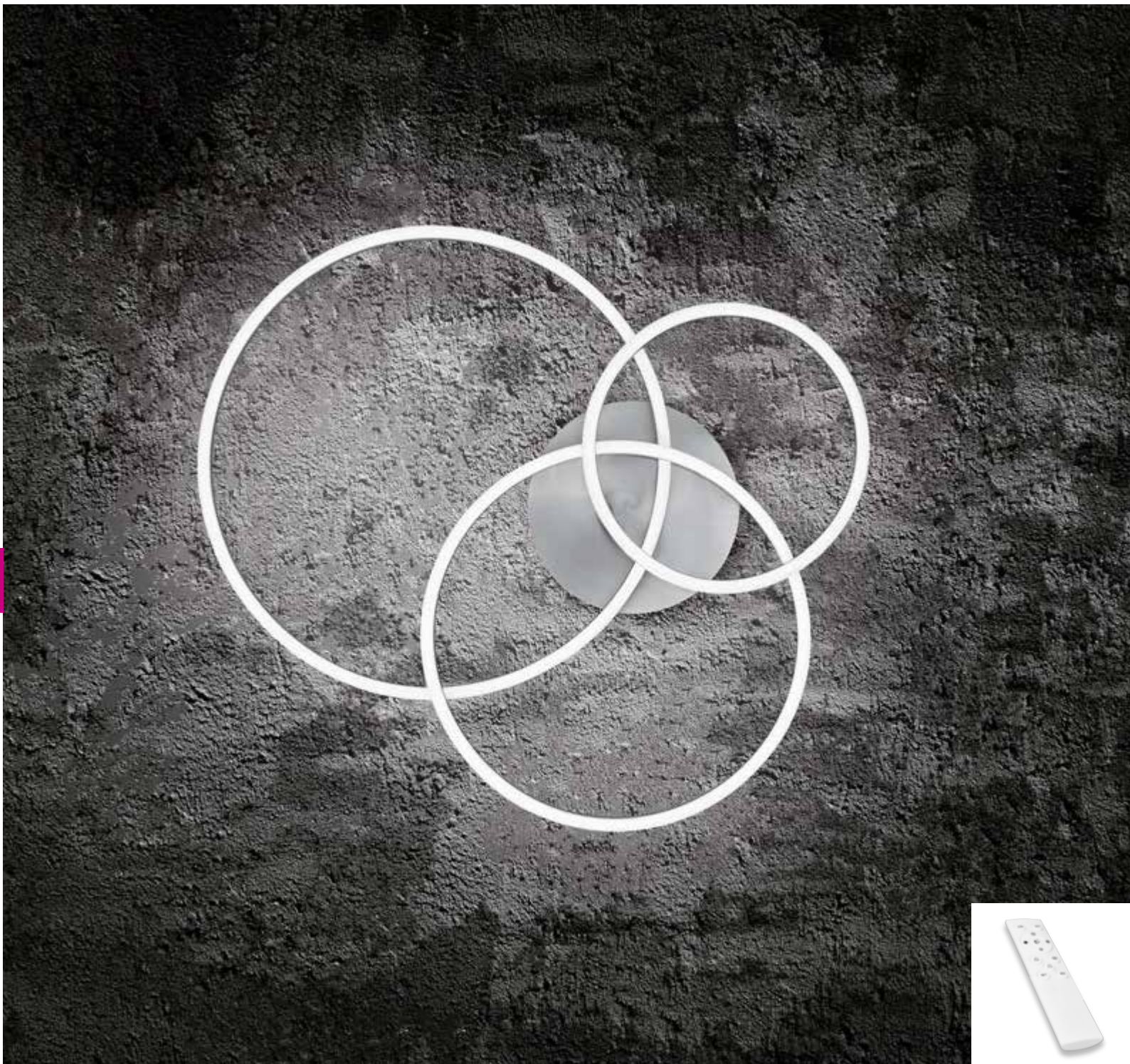

Gibt Licht nach oben und unten, getrennt schaltbar · up and down lighting, separately switchable ·
 point lumineux en haut et en bas, interrupteurs séparés · lichtpunt boven en onder, gescheiden schakelbaar ·
 luz de arriba y abajo, interruptores separados · luce su e giù, interruttori separati · sus și în jos lumina, intreruptoare separate ·
 ylös ja alas valoa, erikseen kytkettävissä · w górę iw dół światło, oddzielny przełącznik

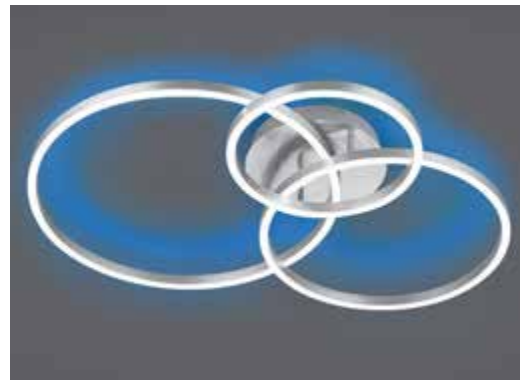
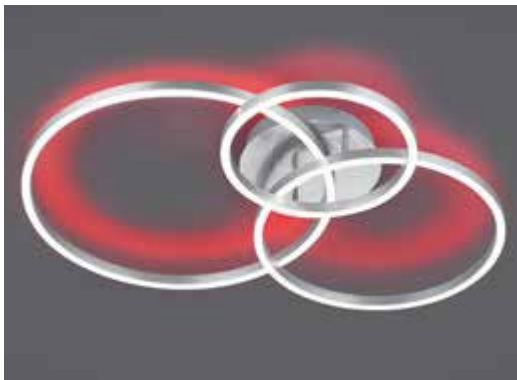





WINONA

Metall, Nickel matt oder Schwarz matt · metal, nickel mat or black mat ·
 metale, nickel mat ou noir mat · metaal, nikkel mat of mat zwart ·
 metal, níquel mate o estera negra · metallo, nichel opaco o nero opaco ·
 metal, nichel mat sau negru mat · metalli, harjattu teräs tai mattamusta ·
 metal, nikiel mat lub czarny mat

 RGBW Farbwechsler ·
 RGBW Colorchanging

 Lichtfarbe stufenlos einstellbar ·
 Light color infinitely variable

 Getrennt schaltbar ·
 Separately switchable

 **07** | Nickel matt · nickel mat

 **32** | Schwarz matt · black mat



Deckenleuchte · Ceiling lamp

↔ 78 x 62 cm, ↑ 11,5 cm
 incl. SMD-LED, 28 W
 3.200 lm, 2.700 - 6.500 K
 incl. RGB-LED, 10 W



670810607
 670810632



TURNER

Chrom, Acryl · chrome, acryl ·
chrome, acryl · chroom, acryl · cromo, acrílico ·
cromo, acrílico · crom, acrilic · kromi, akryyli · chrom, akryl



RGBW Farbwechsler ·
RGBW Colorchanging



Memory Funktion ·
Memory function



Deckenleuchte · Ceiling lamp
Ø 45 cm, ↓ 15 cm
incl. 3 x SMD-LED, 4,2 W
3 x 400 lm, 3.000 K



624410306



DRAGON

Chrom, Acryl · chrome, acryl ·
chrome, acryl · chroom, acryl · cromo, acrílico ·
cromo, acrílico · crom, acrilic · kromi, akryyli · chrom, akryl



RGBW Farbwechsler ·
RGBW Colorchanging



Integrierter Dimmer ·
Integrated dimmer



Wandleuchte · Wall lamp
Ø 69,5 x 74 cm, ↓ 4,5 cm
incl. SMD-LED, 30 W
2.500 lm, 3.000 K
incl. RGB-SMD, 15 W
1.300 lm



620210206



GALE

Metall, Nickel matt, Weiß matt oder Schwarz matt · metal, nickel mat, white mat or black mat ·
 metale, nickel mat, blanc mat ou noir mat · metaal, nikkell mat, wit mat of mat zwart ·
 metal, níquel mate, estera blanca o estera negra · metallo, nichel opaco, bianco opaco o nero
 opaco · metal, nichel mat, alb mat sau negru mat · metalli, harjattu teräs, mattavalkoinen tai
 mattamusta · metal, nikiel mat, biały mat lub czarny mat

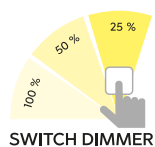

SWITCH DIMMER



07 | Nickel matt ·
nickel mat



31 | Weiß matt ·
white mat



32 | Schwarz matt ·
black mat



Deckenleuchte · Ceiling lamp
 ↔ 60 x 43 cm, ↑ 13,5 cm
 incl. SMD-LED, 38,5 W
 3.850 lm, 3.000 K



673916007
673916031
673916032



Deckenleuchte · Ceiling lamp
 ↔ 80 x 65 cm, ↑ 14,5 cm
 incl. SMD-LED, 50 W
 5.250 lm, 3.000 K



673918007
673918031
673918032



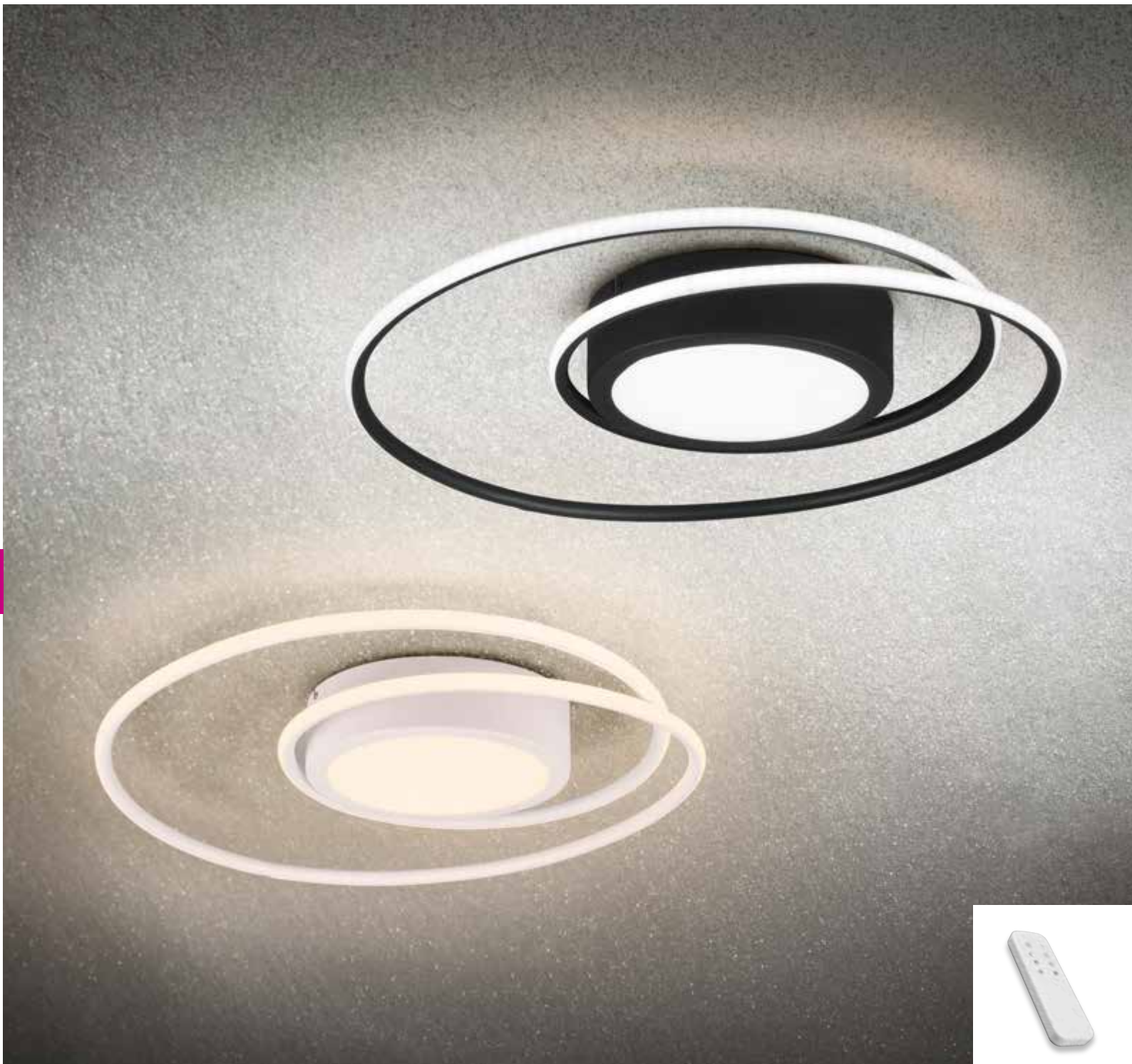

YAVA

Metall, Acryl · metal, acryl ·
metale, acryl · metaal, acryl · metal, acrílico ·
metallo, acrilico · metal, acrilic · metalli, akryyli · metal, akryl



Lichtfarbe stufenlos einstellbar ·
Light color infinitely variable



Integrierter Dimmer ·
Integrated dimmer



07 | Nickel matt · nickel mat



31 | Weiß matt · white mat



32 | Schwarz matt · black mat

Deckenleuchte · Ceiling lamp
Ø 60 cm, ↓ 7 cm
incl. SMD-LED, 56 W
6.800 lm, 2.700 - 6.000 K



672310207
672310231
672310232





DIP SWITCH

Lichtfarben direkt an der Leuchte einstellbar · Colours directly adjustable at the lamp ·
 Les couleurs de la lumière peuvent être réglées directement sur le luminaire ·
 Lichtkleuren direct instelbaar op de lamp · Tonalidades de luz ajustables directamente en la lámpara ·
 Colori della luce regolabili direttamente sulla lampada · Culori ale luminii reglabile direct de la bec ·
 Valon väri asetettävissa suoraan valaisimesta · Barwy światła można ustawić bezpośrednio na oprawie



31 | Weiß matt · white mat



32 | Schwarz matt · black mat



87 | titanfarbig · titan

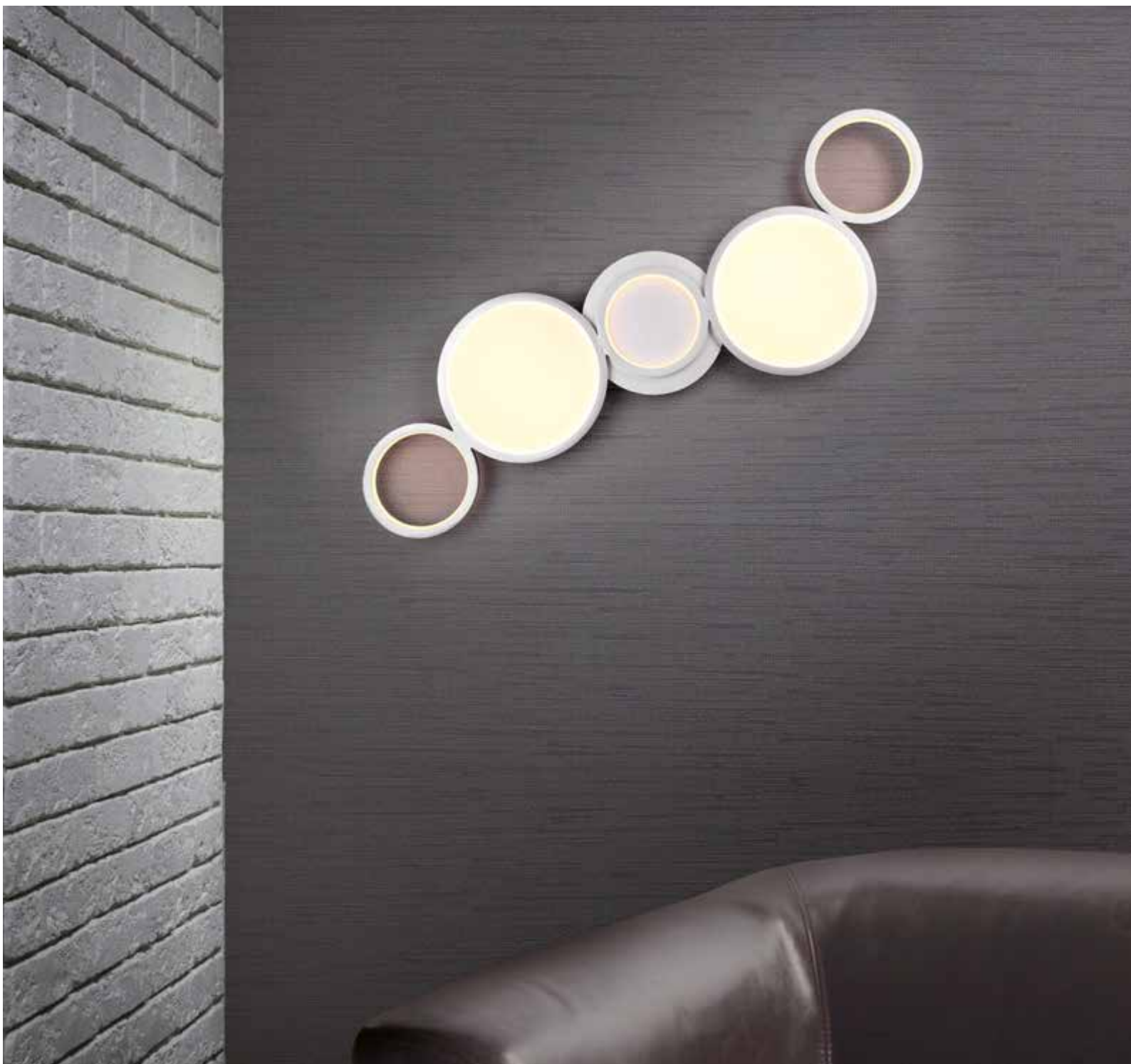

SALSA

Metall, Acryl · metal, acryl ·
metale, acryl · metaal, acryl · metal, acrílico ·
metalho, acrílico · metal, acrilic · metalli, akryyli · metal, akryl

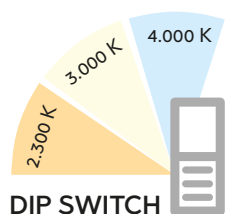

DIP SWITCH

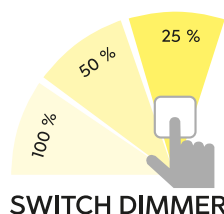

SWITCH DIMMER

Deckenleuchte · Ceiling lamp
↔ 115 x 40,5 cm, ↑ 6,6 cm
incl. SMD-LED, 46 W
5.350 lm, 2.300 + 3.000 + 4.000 K



626710531
626710532
626710587



Deckenleuchte · Ceiling lamp
 ↔ 59 x 43 cm, ↑ 8,5 cm
 incl. SMD-LED, 29 W
 2.650 lm, 3.000 K



673810206
 673810232



Deckenleuchte · Ceiling lamp
 ↔ 85 x 60 cm, ↑ 8,5 cm
 incl. SMD-LED, 36 W
 3.250 lm, 3.000 K



673890206
 673890232

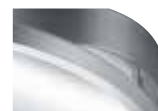

06 | Chrom · chrome



32 | Schwarz matt · black mat



GRANADA

Chrom, Weiß matt oder Schwarz matt, goldfarbig · chrome white mat, or black mat, gold ·
 chrome blanc mat, ou noir mat, or · chrom wit mat, of mat zwart, goud ·
 cromo estera blanca, o estera negra, oro · cromo bianco opaco,
 o nero opaco, oro · crom alb mat, sau negru mat, aur ·
 kromi mattavalkoinen, tai mattamusta, kultaa ·
 chrom biały mat, lub czarny mat, złota

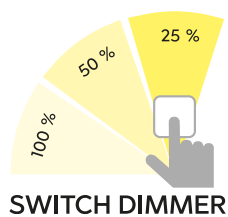

Deckenleuchte · Ceiling lamp
 ↔ 71,5 x 63,5 cm, ↓ 10,5 cm
 incl. SMD-LED, 36 W
 4.300 lm, 3.000 K



673810306
 673810332



SEDONA

Metall, Holznachbildung · metal, wood imitation ·
 metale, imitation bois · metaal, houtimitatie · metal, imitación de madera ·
 metallo, effetto legno · metal, imitație de lemn · metalli, puujäljitelmä · metal, imitacja drewna

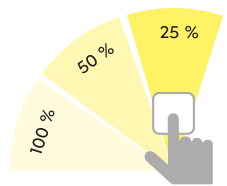

SWITCH DIMMER



06 | Chrom · chrome



31 | Weiß matt · white mat



32 | Schwarz matt, Holznachbildung ·
 black mat, wood imitation

Deckenleuchte · Ceiling lamp
 Ø 80 cm, ↓ 8 cm
 incl. SMD-LED, 40 W
 3.600 lm, 3.000 K



673210306
 673210331
 673210332



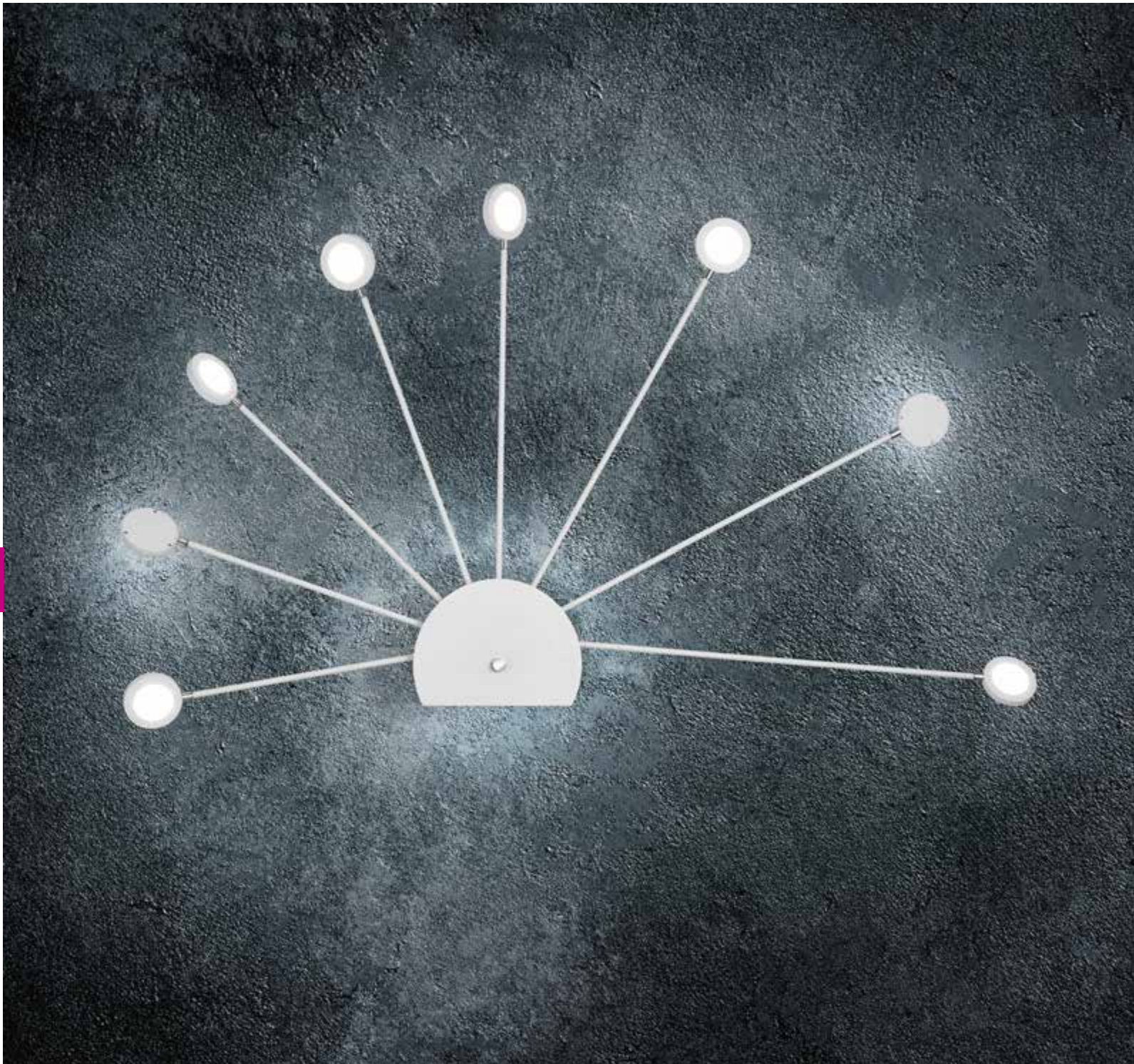

Wandleuchte · Wall lamp
 ↔ 103,5 x 60,5 cm, ∅ 11 cm
 incl. 9 x SMD-LED, 2,6 W
 9 x 270 lm, 4.000 K
 (32 = 9 x 260 lm, 3.000 K)



279570931
 279570932

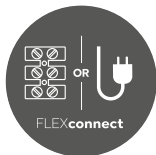

Seite/page 648

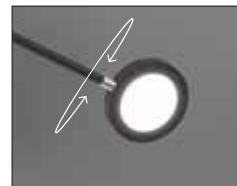
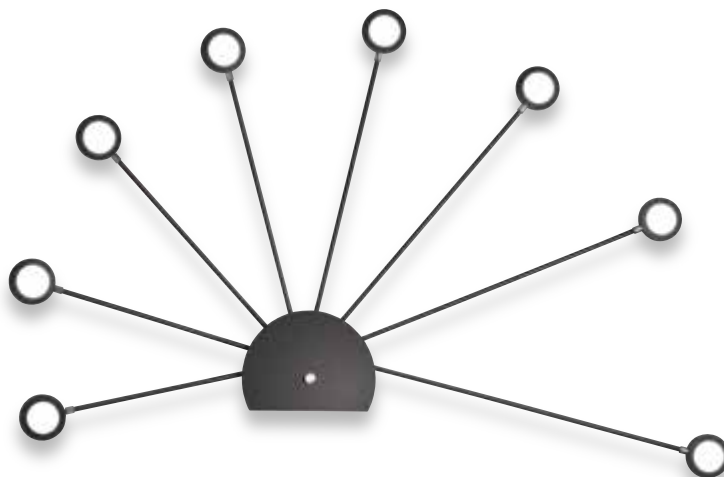



PEACOCK

Metall, Weiß matt oder Schwarz matt · metal, white mat or black mat ·
 metale, blanc mat ou noir mat · metaal, wit mat of mat zwart · metal, estera blanca o estera negra ·
 metallo, bianco opaco o nero opaco · metal, alb mat sau negru mat · metalli, valkoinen matto tai musta matto ·
 metal, biały mat lub czarny mat

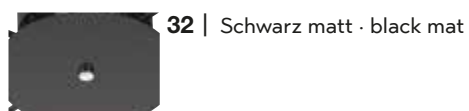
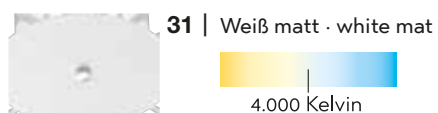
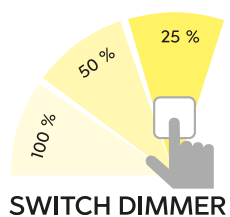

Deckenleuchte · Ceiling lamp
 ↔ 115 x 97,5 cm, ↑ 10,5 cm
 incl. 15 x SMD-LED, 2,6 W
 15 x 270 lm, 4.000 K
 (32 = 15 x 260 lm, 3.000 K)



679511531
 679511532



RUBY

Metall Weiß matt · metal white mat ·
metale blanc mat · metaal wit mat · metal estera blanca ·
metallo bianco opaco · metal alb mat · metalli valkoinen matto · metal biały mat



Dimmbar ·
Dimmable

Deckenleuchte · Ceiling lamp
↔ 35 x 35 cm, ↓ 11 cm
incl. SMD-LED, 18 W
1.800 lm, 3.000 K



623810431



BODRUM

Chrom · chrome ·
chrome · chroom · cromo · cromo · crom · kromi · chrom · krom



Lichtfarbe stufenlos einstellbar ·
Light color infinitely variable



Memory Funktion ·
Memory function



3.000 K

6.500 K

Deckenleuchte · Ceiling lamp
Ø 100 cm, ↑ 8,5 cm
incl. 12 x SMD-LED, 2,1 W
12 x 200 lm, 3.000 - 6.500 K
incl. 1 x SMD-LED, 6,6 W
570 lm, 3.000 - 6.500 K



673311306



TITUS

Metall, Weiß matt · metal, white mat ·
 metale, blanc mat · metaal, wit mat · metal, estera blanca ·
 metallo, bianco opaco · metal, alb mat · metalli, valkoinen matto ·
 metal, biały mat



Lichtfarbe stufenlos einstellbar ·
 Light color infinitely variable



Integrierter Dimmer ·
 Integrated dimmer



Deckenleuchte · Ceiling lamp
 ↔ 50 x 50 cm, ↓ 4,5 cm
 incl. SMD-LED, 22 W
 2.100 lm, 3.000 - 6.000 K



676615031



Deckenleuchte · Ceiling lamp
 ↔ 75 x 75 cm, ↓ 4,5 cm
 incl. SMD-LED, 36 W
 3.300 lm, 3.000 - 6.000 K



676617531



Deckenleuchte · Ceiling lamp
 ↔ 110 x 60 cm, ↓ 4,5 cm
 incl. SMD-LED, 48 W
 4.300 lm, 3.000 - 6.000 K



676611031



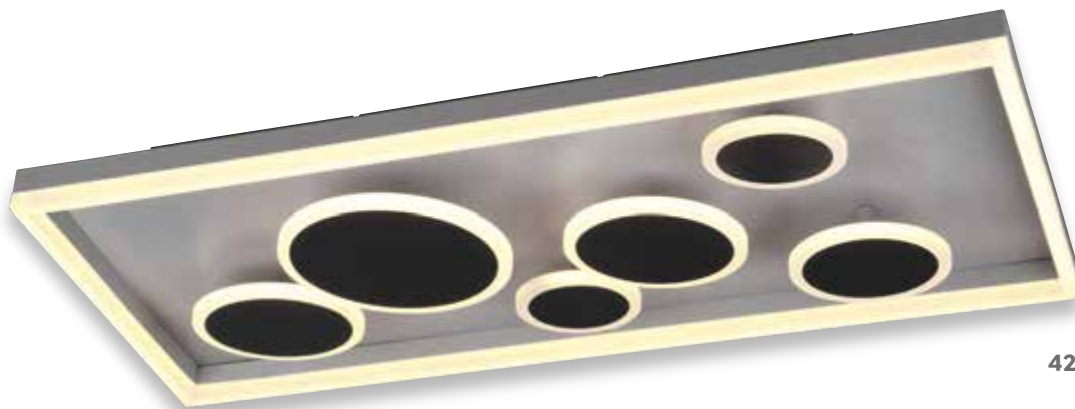

Deckenleuchte · Ceiling lamp

↔ 80 x 40 cm, ↑ 9,2 cm

incl. SMD-LED, 45 W

3.800 lm, 2.500 + 3.500 K



671710742 | Anthrazit / Grau · anthracite / grey

671710779 | goldfarbig / Braun · gold / brown



HARRIET

Metall, goldfarbig / Braun oder Anthrazit / Grau · metal, gold / brown or anthracite / grey ·
 metale, or / brun ou antracite / gris · metaal, goud / bruin of antraciet / grijs ·
 metal, oro / marron o antracita / gris · metallo, oro / marrone o antracite / grigio ·
 metal, aur / maro sau antracit / gri · metalli, kultaa / ruskea tai antrasiitti / harmaa ·
 metal, złota / brązowy lub antracyt / popielaty



SwitchDimtoWarm

Einstellung der Helligkeit und der Lichtfarbe mit herkömmlichem Lichtschalter · Setting the
 brightness and light color with a conventional light switch · Réglage de la luminosité et de la
 couleur de la lumière avec un interrupteur conventionnel · Instelling van de felheid en lichtkleur
 met een gewone lichtschakelaar · Regulación de la claridad y del color de la luz mediante un
 interruptor de la luz convencional · Regolazione del colore e della luminosità della luce con
 un interruttore di tipo convenzionale · Reglarea luminozității și a culorii luminii prin intermediul
 unui întrerupător de lumină uzual · Kirkkauden ja valon värin säätäminen tavallisilla valokytkimillä ·
 Regulacja jasności i barwy światła za pomocą konwencjonalnego włącznika światła



79

Deckenleuchte · Ceiling lamp

↔ 60 x 60 cm, ↓ 9,2 cm
 incl. SMD-LED, 45 W
 3.800 lm, 2.500 + 3.500 K





671710442 | Anthrazit / Grau · anthracite / grey
 671710479 | goldfarbig / Braun · gold / brown



SUBARA

Metall Weiß matt, Acryl · metal white mat, acryl ·
 metale blanc mat, acryl · metaal wit mat, acryl ·
 metal estera blanca, acrílico · metallo bianco opaco, acrilico ·
 metal alb mat, acrilic · metalli valkoinen matto, akryyli · metal biały mat, akryl

 Lichtfarbe stufenlos einstellbar ·
 Light color infinitely variable

 Memory Funktion ·
 Memory function



Deckenleuchte · Ceiling lamp
 ↔ 40 x 26 cm, ↑ 5,6 cm
 incl. SMD-LED, 20 W
 2.100 lm, 3.000 + 4.000 K



274510107



Deckenleuchte · Ceiling lamp
 ↔ 88 x 58 cm, ↑ 6,4 cm
 incl. SMD-LED, 58 W
 5.400 lm, 3.000 - 5.500 K



674510107



KAGAWA

Metall Weiß matt, Acryl · metal white mat, acryl ·
 metale blanc mat, acryl · metaal wit mat, acryl ·
 metal estera blanca, acrílico · metallo bianco opaco, acrilico ·
 metal alb mat, acrilic · metalli valkoinen matto, akryyli · metal biały mat, akryl



Lichtfarbe stufenlos einstellbar ·
 Light color infinitely variable



Memory Funktion ·
 Memory function



Nachtlicht ·
 Night light



Deckenleuchte · Ceiling lamp
 Ø 50 cm, ↓ 6 cm
 incl. SMD-LED, 40 W
 5.000 lm, 2.700 - 6.000 K



625815031



RAVEN

Schiefer, Schwarz · Shale, black ·
 Ardoise, noir · Leisteen, zwart · Pizarra, negro ·
 Ardesia, nero · Ardezie, negru · Savi, musta · łupek, czarny

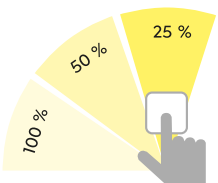

SWITCH DIMMER

 indirekte Beleuchtung ·
 indirect lighting



Wandleuchte · Wall lamp
 Ø 20 cm, ↗ 3,6 cm
 incl. SMD-LED, 9 W
 1.000 lm, 3.000 K



224290102



Wandleuchte · Wall lamp
 ↔ 25 x 12 cm, ↗ 3,6 cm
 incl. SMD-LED, 9 W
 1.000 lm, 3.000 K



224210102

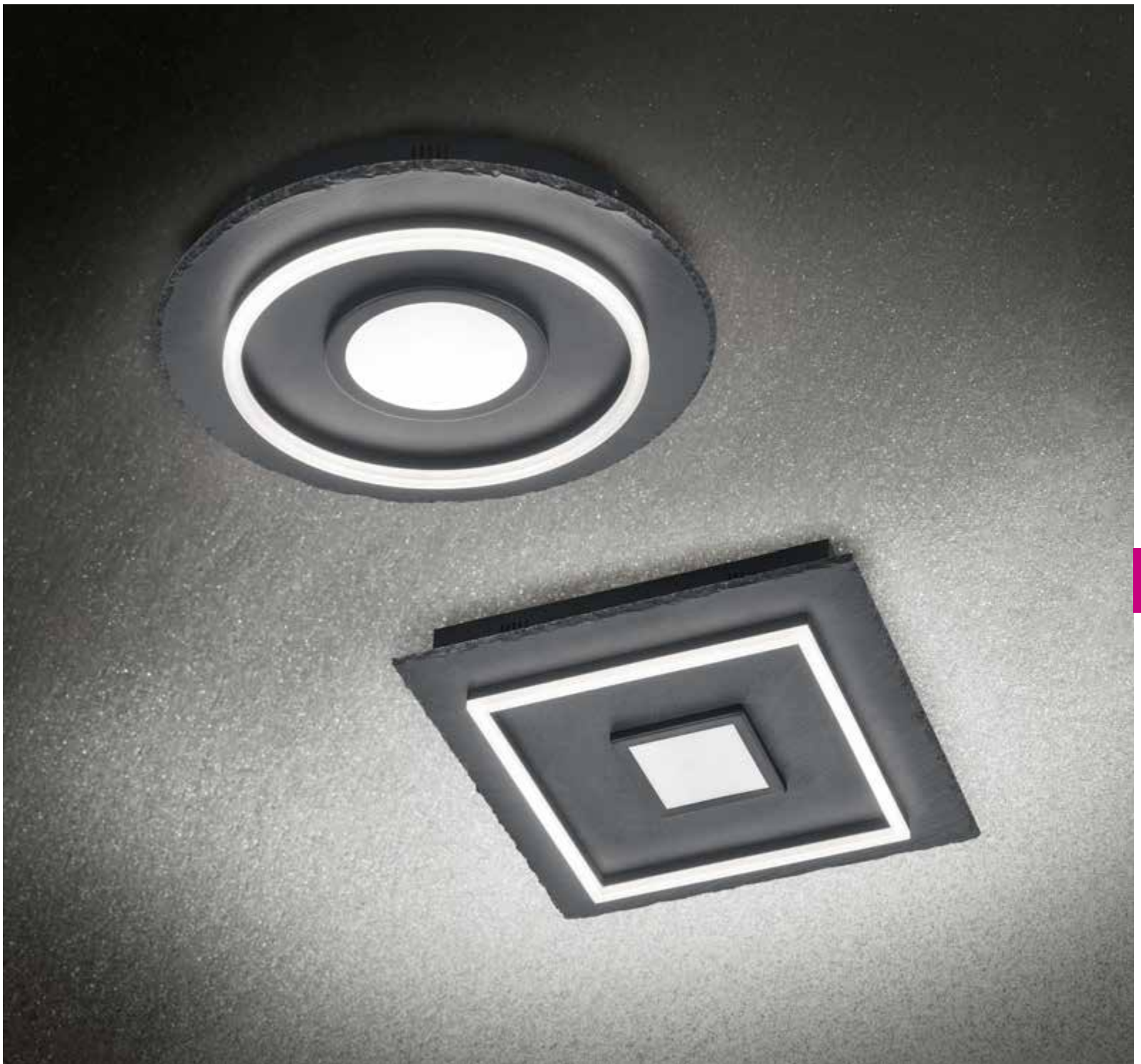

CORBIE

Schiefer, Schwarz · Shale, black ·
 Ardoise, noir · Leisteen, zwart · Pizarra, negro · Ardesia, nero ·
 Ardezie, negru · Savi, musta · łupek, czarny

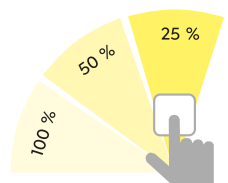

SWITCH DIMMER



Wandleuchte · Wall lamp
 Ø 40 cm, ↗ 6,4 cm
 incl. SMD-LED, 27 W
 3.100 lm, 3.000 K



672810202

Wandleuchte · Wall lamp
 ↔ 40 x 40 cm, ↑ 6,4 cm
 incl. SMD-LED, 31 W
 3.600 lm, 3.000 K



672819202



Getrennt schaltbar ·
Separately switchable





VERUS

Metall, Acryl · metal, acryl ·
 metale, acryl · metaal, acryl · metal, acrílico ·
 metallo, acrilico · metal, acrylic · metalli, akryyli · metal, akryl

 Lichtfarbe stufenlos einstellbar ·
 Light color infinitely variable

 Integrierter Dimmer ·
 Integrated dimmer



07 | Nickel matt · nickel mat

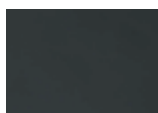

32 | Schwarz matt · black mat



Deckenleuchte · Ceiling lamp
 Ø 50 cm, ↓ 7,2 cm
 incl. SMD-LED, 30 W
 3.000 lm, 3.000 K
 incl. SMD-LED, 20 W
 2.000 lm, 3.000 K



626910307
 626910332



Deckenleuchte · Ceiling lamp
 Ø 70 cm, ↓ 7,2 cm
 incl. SMD-LED, 40 W
 4.000 lm, 3.000 K
 incl. SMD-LED, 25 W
 2.500 lm, 3.000 K



626919307
 626919332

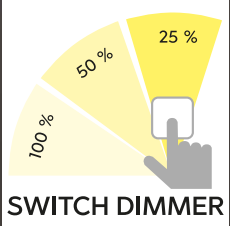

31 | Weiß matt · white mat



32 | Schwarz matt · black mat



Deckenleuchte · Ceiling lamp
 Ø 45 cm, ↑ 11 cm
 incl. SMD-LED, 27 W
 3.100 lm, 3.000 K
(31 = 3.200 lm, 4.000 K)



671210131
671210132



GIRONA

Metall, Acryl · metal, acryl ·
metale, acryl · metaal, acryl · metal, acrílico ·
metallo, acrilico · metal, acrilic · metalli, akryyli · metal, akryl



2.700 K

6.500 K



Deckenleuchte · Ceiling lamp

Ø 60 cm, ↓ 12 cm

incl. SMD-LED, 48 W

5.600 lm, 2.700 - 6.000 K



671290131

671290132

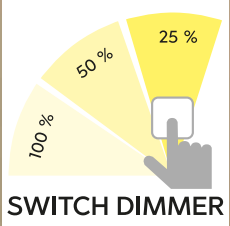

Deckenleuchte · Ceiling lamp
 Ø 21 cm, ↓ 5 cm
 incl. SMD-LED, 12 W
 1.050 lm, 3.000 K



679112132



Deckenleuchte · Ceiling lamp
 Ø 42 cm, ↓ 7,5 cm
 incl. SMD-LED, 18 W
 1.800 lm, 3.000 - 5.500 K



679114232



Deckenleuchte · Ceiling lamp
 Ø 65 cm, ↓ 10 cm
 incl. SMD-LED, 50 W
 5.000 lm, 3.000 - 5.500 K



679110032



OKINAWA

Metall, Acryl, Schwarz matt · metal, acryl, black mat ·
 metale, acryl, noir mat · metaal, acryl, mat zwart · metal, acrílico, estera negra ·
 metallo, acrilico, nero opaco · metal, acrilic, negru mat · metalli, akryyli, mattamusta · metal, akryl, czarny mat



Lichtfarbe stufenlos einstellbar ·
 Light color infinitely variable



Integrierter Dimmer ·
 Integrated dimmer



Memory Funktion ·
 Memory function



3.000 K

5.500 K

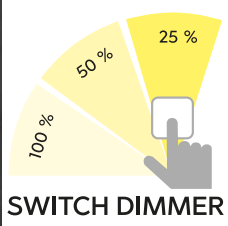

Deckenleuchte · Ceiling lamp
 Ø 21 cm, ↓ 5 cm
 incl. SMD-LED, max. 12 W
 max. 1.050 lm, 3.000 K



678711206



Deckenleuchte · Ceiling lamp
 Ø 42 cm, ↓ 7 cm
 incl. SMD-LED, max. 30 W
 max. 3.100 lm, 3.000 - 5.500 K



678713006



Deckenleuchte · Ceiling lamp
 Ø 67 cm, ↓ 10 cm
 incl. SMD-LED, max. 100 W
 max. 9.800 lm, 3.000 - 5.500 K





678710006



OSAKA

Chrom, Acryl, Starlight-Effekt · chrome, acryl, starlight effect ·
 chrome, acryl, effet étoile · chroom, acryl, sterlicht effect · cromo, acrílico, efecto de la luz · cromo, acrilico, effetto di stelle ·
 crom, acrilic, efect lumina stelelor · kromi, akryyli, starlight vaikutus · chrom, akryl, efekt starlight

 Lichtfarbe stufenlos einstellbar ·
 Light color infinitely variable

 Integrierter Dimmer ·
 Integrated dimmer

 Memory Funktion ·
 Memory function



2.700 K

6.000 K



SAPPORO

Acryl, Starlight-Effekt · acryl, starlight effect ·
 acryl, effet étoile · acryl, sterlicht effect ·
 acrílico, efecto de la luz · acrílico, effetto di stelle ·
 acrilic, efect lumina stelelor · akryyli, starlight vaikutus ·
 akryl, efekt starlight

 Lichtfarbe stufenlos einstellbar ·
 Light color infinitely variable

 Integrierter Dimmer ·
 Integrated dimmer

 Memory Funktion ·
 Memory function



Deckenleuchte · Ceiling lamp
 ↔ 41,5 x 41,5 cm, ↑ 7,5 cm
 incl. SMD-LED, max. 30 W
 max. 2.100 lm, 3.000 - 5.500 K



677610106



Deckenleuchte · Ceiling lamp
 ↔ 51,5 x 51,5 cm, ↑ 8,5 cm
 incl. SMD-LED, max. 60 W
 max. 4.500 lm, 3.000 - 5.500 K



677690106



MIKO

Chrom, Acryl, Starlight-Effekt · chrome, acryl, starlight effect ·
 chrome, acryl, effet étoile · chroom, acryl, sterlicht effect ·
 cromo, acrílico, efecto de la luz · cromo, acrilico, effetto di stelle ·
 crom, acrilic, efect lumina stelelor · kromi, akryyli, starlight vaikutus ·
 chrom, akryl, efekt starlight · krom, akrilik, starlight etkisi



Lichtfarbe stufenlos einstellbar ·
 Light color infinitely variable



Integrierter Dimmer ·
 Integrated dimmer



Memory Funktion ·
 Memory function



3.000 K

5.500 K

Deckenleuchte · Ceiling lamp

Ø 85 cm, ↓ 12,5 cm

incl. SMD-LED, 95 W

9.600 lm, 3.000 - 5.500 K



675610106

TOKYO

Acryl · acryl ·
acryl · acryl · acrílico · acrilico · acrilic · akryyli · akryl



Lichtfarbe stufenlos einstellbar ·
Light color infinitely variable



Memory Funktion ·
Memory function



Deckenleuchte · Ceiling lamp

Ø 60 cm, ↑ 6,5 cm
incl. SMD-LED, 45 W
4.000 lm, 3.000 - 5.500 K



628915001



LOTUS

Acryl, Weiß, Chrom · acryl, white, chrome ·
acryl, blanc, chrome · acryl, wit, chroom ·
acrílico, blanco, cromo · acrilico, bianco, cromo ·
acrilic, alb, crom · akryyli, valkoinen, kromi ·
akryl, biały, chrom



Lichtfarbe stufenlos einstellbar ·
Light color infinitely variable



Memory Funktion ·
Memory function



Deckenleuchte · Ceiling lamp

Ø 60 cm, ↑ 7,5 cm
incl. SMD-LED, max. 45 W
4.000 lm, 3.000 - 5.500 K



629010101





NAGANO

Acryl, Starlight-Effekt · acryl, starlight effect ·
 acryl, effet étoile · acryl, sterlicht effect · acrílico, efecto de la luz ·
 acrilico, effetto di stelle · acrilic, efect lumina stelelor · akryyli, starlight vaikutus · akryl, efekt starlight



Lichtfarbe stufenlos einstellbar ·
 Light color infinitely variable



Memory Funktion ·
 Memory function



Deckenleuchte · Ceiling lamp

Ø 80 cm, ↑ 10,8 cm
 incl. SMD-LED, max. 80 W
 max. 6.400 lm, 3.000 - 5.500 K



677718000

NORIAKI

Chrom, Acryl, Starlight-Effekt · chrome, acryl, starlight effect · chrome, acryl, effet étoile · chroom, acryl, sterlicht effect · cromo, acrílico, efecto de la luz · cromo, acrilico, effetto di stelle · crom, acrilic, efect lumina stelelor · kromi, akryyli, starlight vaikutus · chrom, akryl, efekt starlight

 Lichtfarbe stufenlos einstellbar · Light color infinitely variable

 Integrierter Dimmer · Integrated dimmer

 Memory Funktion · Memory function





Deckenleuchte · Ceiling lamp

Ø 59,5 cm, ↓ 10 cm
incl. SMD-LED, 45 W
4.000 lm, 3.000-5.500 K

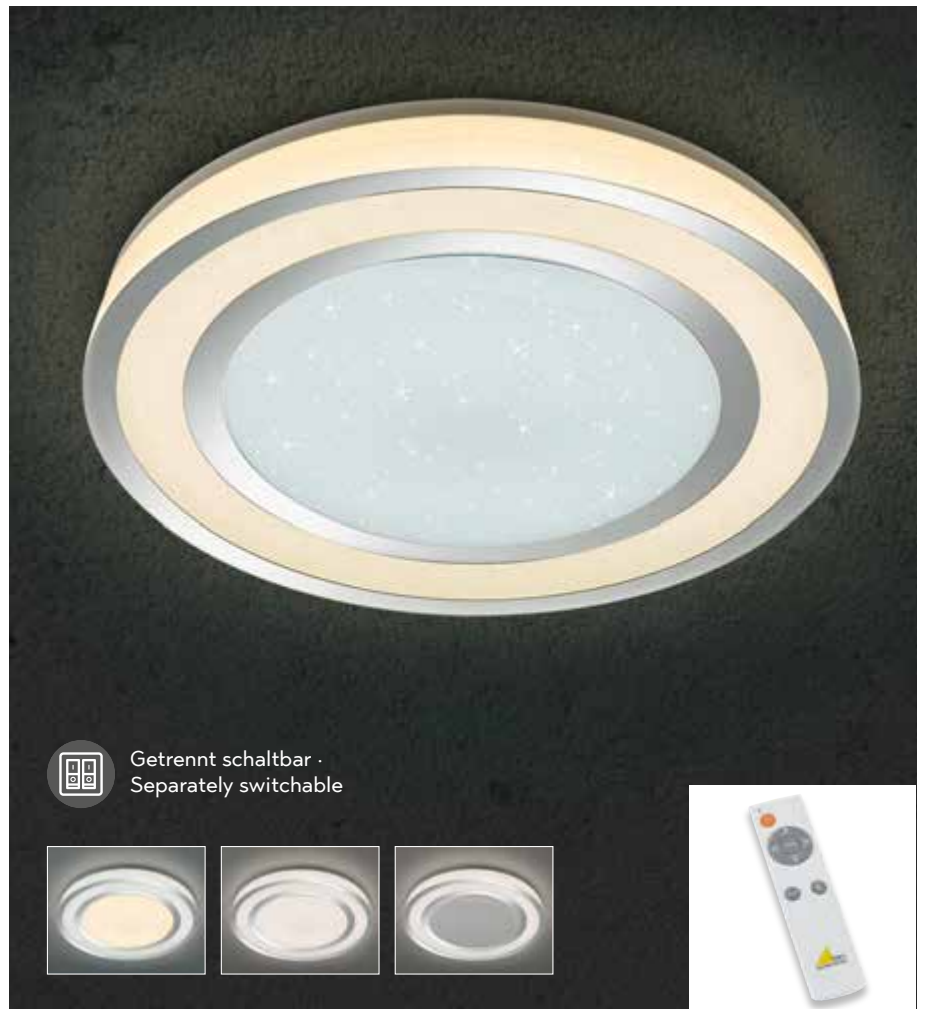

679210106



 Getrennt schaltbar · Separately switchable



CONDOR

Acryl, Starlight-Effekt · acryl, starlight effect · acryl, effet étoile · acryl, sterlicht effect · acrílico, efecto de la luz · acrilico, effetto di stelle · acrilic, efect lumina stelelor · akryyli, starlight vaikutus · akryl, efekt starlight



Deckenleuchte · Ceiling lamp

Ø 42 cm, ↓ 9,5 cm
incl. SMD-LED, 21 W
2.200 lm, 4.000 K



657810100

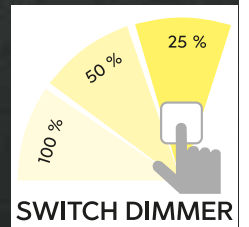
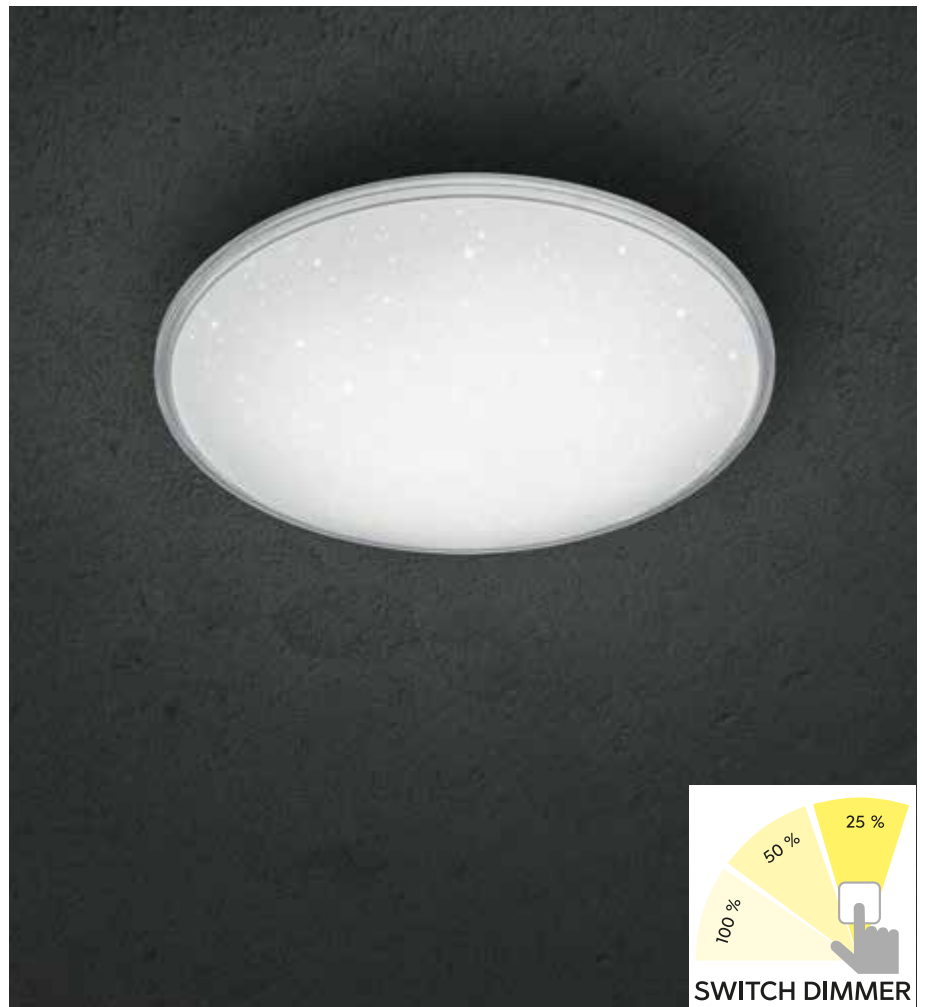



LUNAR

Kunststoff · plastic ·
plastique · kunststof · plástico · plastica · plastic · muovi · plastik · plastik

Mondphasen individuell einstellbar · Phases of the moon individually adjustable ·
Phases de lune réglables · Maanstanden apart instelbaar ·
Fases lunares ajustables individualmente · Fasi lunari regolabili individualmente ·
Fazele lunii reglabile individual · Kuun vaiheet erikseen säädettävissä ·
Cykl księżyca indywidualnie regulowany

 Musterschutz ·
Registered model

 Integrierter Dimmer ·
Integrated dimmer



Deckenleuchte · Ceiling lamp
Ø 40 cm, ↓ 10 cm
incl. SMD-LED, 22 W
2.000 lm, 3.000 K



627514000



Deckenleuchte · Ceiling lamp
Ø 60 cm, ↓ 12 cm
incl. SMD-LED, 40 W
3.500 lm, 3.000 K



627516000

SHOGUN

Acryl, Starlight-Effekt · acryl, starlight effect ·
acryl, effet étoile · acryl, sterlicht effect ·
acrílico, efecto de la luz · acrilico, effetto di stelle ·
acrilic, efect lumina stelelor · akryyli, starlight vaikutus ·
akryl, efekt starlight



Lichtfarbe stufenlos einstellbar ·
Light color infinitely variable



Memory Funktion ·
Memory function

Deckenleuchte · Ceiling lamp

Ø 42,5 cm, ↓ 6 cm
incl. SMD-LED, 21,5 W
2.400 lm, 3.000-5.500 K



628513001



SAMURAI

Acryl, Starlight-Effekt · acryl, starlight effect ·
acryl, effet étoile · acryl, sterlicht effect ·
acrílico, efecto de la luz · acrilico, effetto di stelle ·
acrilic, efect lumina stelelor · akryyli, starlight vaikutus ·
akryl, efekt starlight



Lichtfarbe stufenlos einstellbar ·
Light color infinitely variable



Memory Funktion ·
Memory function

Deckenleuchte · Ceiling lamp

↔ 42,5 x 42,5 cm, ↓ 6 cm
incl. SMD-LED, 21,5 W
2.400 lm, 3.000-5.500 K



628613001



RAIKO

Acryl, Starlight-Effekt · acryl, starlight effect ·
acryl, effet étoile · acryl, sterlicht effect ·
acrílico, efecto de la luz · acrilico, effetto di stelle ·
acrilic, efect lumina stelelor · akryyli, starlight vaikutus ·
akryl, efekt starlight ·



Lichtfarbe stufenlos einstellbar ·
Light color infinitely variable



Memory Funktion ·
Memory function

Deckenleuchte · Ceiling lamp

42,5 x 42,5 cm, ↑ 6 cm
incl. SMD-LED, 21,5 W
2.400 lm, 3.000-5.500 K



678613001



363

SEIKO

Acryl, Starlight-Effekt · acryl, starlight effect ·
acryl, effet étoile · acryl, sterlicht effect ·
acrílico, efecto de la luz · acrilico, effetto di stelle ·
acrilic, efect lumina stelelor · akryyli, starlight vaikutus ·
akryl, efekt starlight



Lichtfarbe stufenlos einstellbar ·
Light color infinitely variable



Memory Funktion ·
Memory function

Deckenleuchte · Ceiling lamp

Ø 42,5 cm, ↑ 6 cm
incl. SMD-LED, 21,5 W
2.400 lm, 3.000-5.500 K



678513001





FERNANDO

Metall, Weiß matt oder Schwarz matt · metal, white mat or black mat ·
 metale, blanc mat ou noir mat · metaal, wit mat of mat zwart ·
 metal, estera blanca o estera negra · metallo, bianco opaco o nero opaco ·
 metal, alb mat sau negru mat · metalli, valkoinen matto tai musta matto ·
 metal, biały mat lub czarny mat

Empfohlen:

recommended: LED GU10, 5 W
 400 lm, 3.000 K



956-5936



31 | Weiß matt · white mat



32 | Schwarz matt · black mat



Deckenleuchte · Ceiling lamp

↔ 23 x 20 cm, ↓ 15 cm
 excl. 3 x GU10, max. 35 W



604900331
 604900332



Deckenleuchte · Ceiling lamp

↔ 37 x 30 cm, ↓ 15 cm
 excl. 6 x GU10, max. 35 W



604900631
 604900632





COOKIE

Metall, Weiß matt oder Schwarz matt · metal, white mat or black mat ·
 metale, blanc mat ou noir mat · metaal, wit mat of mat zwart · metal, estera blanca o estera negra · metallo, bianco opaco o nero opaco ·
 metal, alb mat sau negru mat · metalli, valkoinen matto tai musta matto · metal, biały mat lub czarny mat



Deckenleuchte · Ceiling lamp
 Ø 9,6 cm, ↑ 12,5 cm
 excl. 1 x GU10, max. 35 W



612900131
 612900132



Deckenleuchte · Ceiling lamp
 ↔ 17,8 x 9,6 cm, ↑ 12,5 cm
 excl. 2 x GU10, max. 35 W



612900231
 612900232



Deckenleuchte · Ceiling lamp
 ↔ 17,8 x 17,8 cm, ↑ 12,5 cm
 excl. 4 x GU10, max. 35 W



612900431
 612900432

Empfohlen:
 recommended: LED GU10, 5 W
 400 lm, 3.000 K



956-5936



BISCUIT

Metall, Weiß matt oder Schwarz matt · metal, white mat or black mat ·
 metale, blanc mat ou noir mat · metaal, wit mat of mat zwart · metal, estera blanca o estera negra · metallo, bianco opaco o nero opaco ·
 metal, alb mat sau negru mat · metalli, valkoinen matto tai musta matto · metal, biały mat lub czarny mat



31 | Weiß matt · white mat



32 | Schwarz matt · black mat

Deckenleuchte · Ceiling lamp
 ↔ 9,6 x 9,6 cm, ↓ 12,5 cm
 excl. 1 x GU10, max. 35 W



613000131
 613000132

Deckenleuchte · Ceiling lamp
 ↔ 17,8 x 9,6 cm, ↓ 12,5 cm
 excl. 2 x GU10, max. 35 W



613000231
 613000232

Deckenleuchte · Ceiling lamp
 ↔ 17,8 x 17,8 cm, ↓ 12,5 cm
 excl. 4 x GU10, max. 35 W



613000431
 613000432

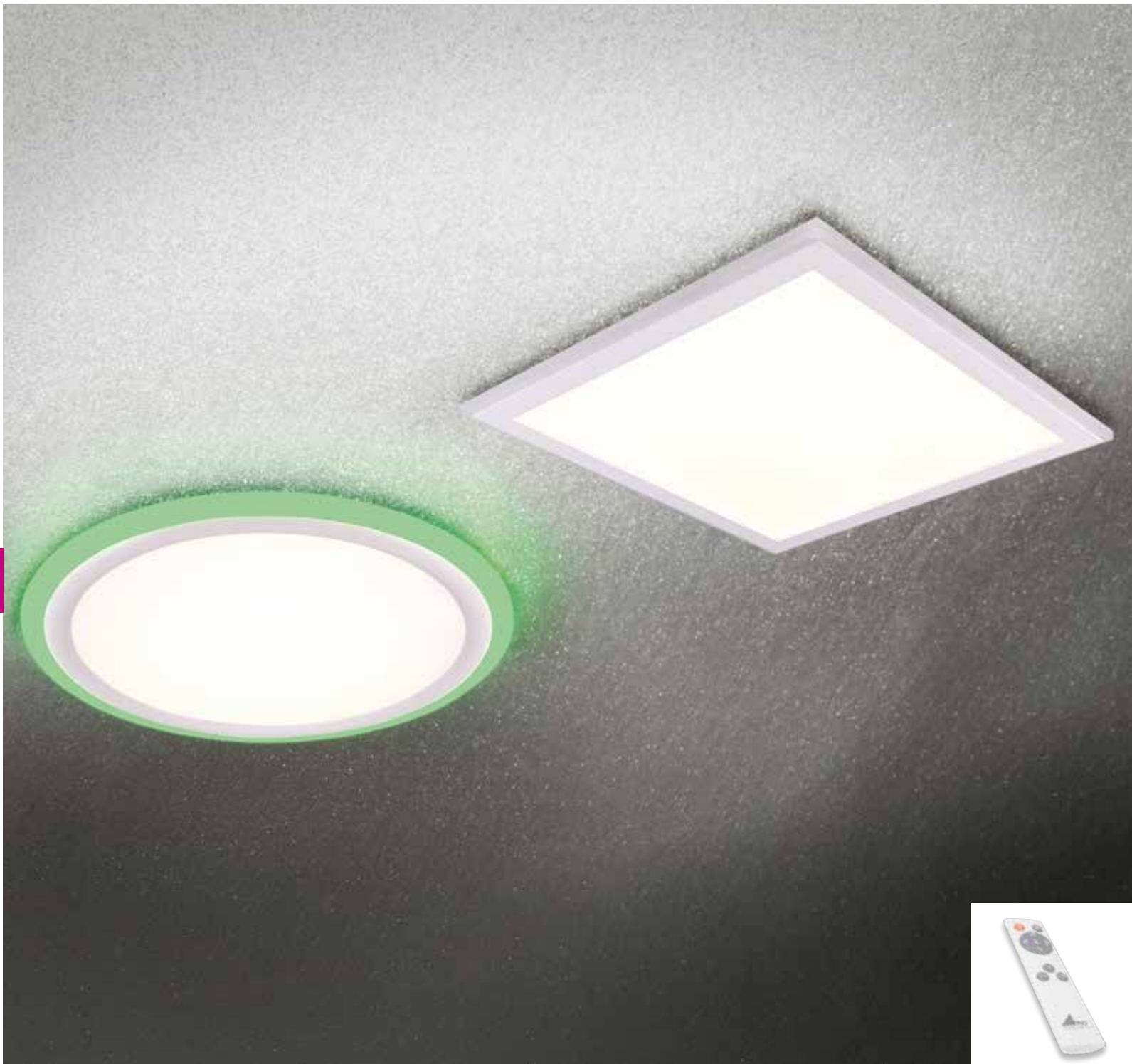

Deckenleuchte · Ceiling lamp

↔ 100 x 25 cm, ↓ 5,5 cm
incl. SMD-LED, 38 W
4.000 lm, 2.700 - 6.500 K

Deckenleuchte · Ceiling lamp

↔ 45 x 45 cm, ↓ 5,5 cm
incl. SMD-LED, 28 W
3.200 lm, 2.700 - 6.500 K

Deckenleuchte · Ceiling lamp

Ø 50 cm, ↓ 5,5 cm
incl. SMD-LED, 45 W
5.000 lm, 2.700 - 6.500 K



679010031

679015031

679095031



COLUMBIA

Kunststoff, Acryl · plastic, acryl ·
 plastique, acryl · kunststof, acryl · plástico, acrílico ·
 plastica, acrilico · plastic, acrylic · muovi, akryyli · plastik, akryl



Lichtfarbe stufenlos einstellbar ·
 Light color infinitely variable



RGBW Farbwechsler ·
 RGBW Colorchanging



Memory Funktion ·
 Memory function



Getrennt schaltbar ·
 Separately switchable





Deckenleuchte · Ceiling lamp
 Ø 30 cm, ↑ 4,2 cm
 incl. SMD-LED, 15 W
 1.500 lm, 3.000 K



674093007



Deckenleuchte · Ceiling lamp
 Ø 45 cm, ↑ 4,2 cm
 incl. SMD-LED, 25 W
 2.500 lm, 3.000 K



674094507



Deckenleuchte · Ceiling lamp
 Ø 62 cm, ↑ 4,2 cm
 incl. SMD-LED, 30 W
 3.000 lm, 3.000 K



674096207



Deckenleuchte · Ceiling lamp
 ↔ 30 x 30 cm, ↑ 4,2 cm
 incl. SMD-LED, 15 W
 1.500 lm, 3.000 K



674013007



PHOENIX

Nickel matt, Acryl · nickel mat, acryl ·
 nickel mat, acryl · nikkel mat, acryl · níquel mate, acrílico · nichel opaco, acrílico ·
 nichel mat, acrílic · harjattu teräs, akryyli · nikiel mat, akryl .



Dimmbar ·
 Dimmable



Deckenleuchte · Ceiling lamp
 ↔ 45 x 45 cm, ↓ 4,2 cm
 incl. SMD-LED, 25 W
 2.500 lm, 3.000 K



674014507



Deckenleuchte · Ceiling lamp
 ↔ 62 x 62 cm, ↓ 4,2 cm
 incl. SMD-LED, 30 W
 3.000 lm, 3.000 K



674016207



Deckenleuchte · Ceiling lamp
 ↔ 120 x 30 cm, ↓ 4,2 cm
 incl. SMD-LED, 30 W
 3.000 lm, 3.000 K



674011207



GONZALO

Kunststoff, Weiß oder titanfarbig · plastic, white or titan ·
 plastique, blanc ou titane · kunststof, wit of titaan · plástico, blanco o titán ·
 plastica, bianco o titano · plastic, alb sau titaniu · muovi, valkoinen tai titaani ·
 plastik, biały lub tytanowy



Dimmbar ·
 Dimmable



Deckenleuchte · Ceiling lamp
 Ø 29 cm, ↑ 8 cm
 incl. SMD-LED, 9 W
 750 lm, 3.000 K



626510987



Deckenleuchte · Ceiling lamp
 Ø 34 cm, ↑ 9 cm
 incl. SMD-LED, 12 W
 1.050 lm, 3.000 K



626511287



Deckenleuchte · Ceiling lamp
 Ø 42 cm, ↑ 10 cm
 incl. SMD-LED, 25 W
 2.000 lm, 3.000 K



626512587



CESAR

Chrom, Acryl mit Kristalleffekt · chrome, broken glass optic ·
 chrome, optique verre pilé · chroom, Gebroken glas optiek · cromo, Efecto cristal roto ·
 cromo, effetto ottico vetro rotto · crom, aspect de sticla sparta · kromi, lasi efekti optiikka · chrom, Optyczne rozbite szkło

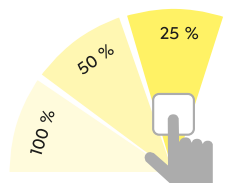

SWITCH DIMMER



Deckenleuchte · Ceiling lamp
 Ø 26 cm, ↑ 3 cm
 incl. SMD-LED, 15 W
 1.350 lm, 3.000 K



IP44

656411506



Deckenleuchte · Ceiling lamp
 Ø 40 cm, ↑ 3 cm
 incl. SMD-LED, 24 W
 2.000 lm, 3.000 K



IP44

656412406



Deckenleuchte · Ceiling lamp
 ↔ 30 x 30 cm, ↑ 3 cm
 incl. SMD-LED, 18 W
 1.650 lm, 3.000 K



IP44

656511806



Deckenleuchte · Ceiling lamp
 ↔ 40 x 40 cm, ↑ 3 cm
 incl. SMD-LED, 24 W
 2.000 lm, 3.000 K



IP44

656512006



ZEUS

Metall, Nickel matt oder Weiß matt · metal, nickel mat or white mat ·
 metale, nickel mat ou blanc mat · metaal, nikkel mat of wit mat · metal, níquel mate o estera blanca ·
 metallo, nichel opaco o bianco opaco · metal, nichel mat sau alb mat · metalli, harjattu teräs tai mattavalkoinen ·
 metal, nikiel mat lub biały mat



01 | Weiß · white



07 | Nickel matt · nickel mat

Deckenleuchte · Ceiling lamp

↔ 12 x 12 cm, ↑ 3,5 cm
 incl. SMD-LED, 5,5 W
 450 lm, 3.000 K

657110601
 657110607

Deckenleuchte · Ceiling lamp

↔ 18 x 18 cm, ↑ 3,5 cm
 incl. SMD-LED, 12,5 W
 1.100 lm, 3.000 K

657111201
 657111207

Deckenleuchte · Ceiling lamp

↔ 22,5 x 22,5 cm, ↑ 3,5 cm
 incl. SMD-LED, 17 W
 1.600 lm, 3.000 K

657111801
 657111807



CENTO

Metall, Nickel matt oder Weiß matt · metal, nickel mat or white mat ·
 metale, nickel mat ou blanc mat · metaal, nikkel mat of wit mat · metal, níquel mate o estera blanca ·
 metallo, nichel opaco o bianco opaco · metal, nichel mat sau alb mat · metalli, harjattu teräs tai mattavalkoinen ·
 metal, nikiel mat lub biały mat



Deckenleuchte · Ceiling lamp
 Ø 12 cm, ↑ 3,5 cm
 incl. SMD-LED, 5,5 W
 450 lm, 3.000 K

657010601
 657010607



Deckenleuchte · Ceiling lamp
 Ø 18 cm, ↑ 3,5 cm
 incl. SMD-LED, 11,5 W
 1.100 lm, 3.000 K

657011201
 657011207



Deckenleuchte · Ceiling lamp
 Ø 22,5 cm, ↑ 3,5 cm
 incl. SMD-LED, 17 W
 1.600 lm, 3.000 K

657011801
 657011807

CLEO

Metall, goldfarbig · metal, gold ·
metale, or · metaal, goud · metal, oro · metallo, oro ·
metal, aur · metalli, kultaa · metal, złota



Wandleuchte · Wall lamp
↓ 15 x 8 cm, ↗ 8 cm
excl. 2 x GU10, max. 35 W



206500279



Wandleuchte · Wall lamp
↓ 16,5 x 6 cm, ↗ 10 cm
excl. 2 x GU10, max. 35 W



206400279

Empfohlen:
recommended: LED GU10, 5 W
400 lm, 3.000 K



956-55



AURORA

Metall, goldfarbig · metal, gold ·
metale, or · metaal, goud · metal, oro · metallo, oro ·
metal, aur · metalli, kultaa · metal, złota



Wandleuchte · Wall lamp
↗ 12 cm, Ø 20 cm
incl. 1 x SMD-LED, 3,1 W, 310 lm
incl. 1 x SMD-LED, 3 W, 200 lm
3.000 K



223810279

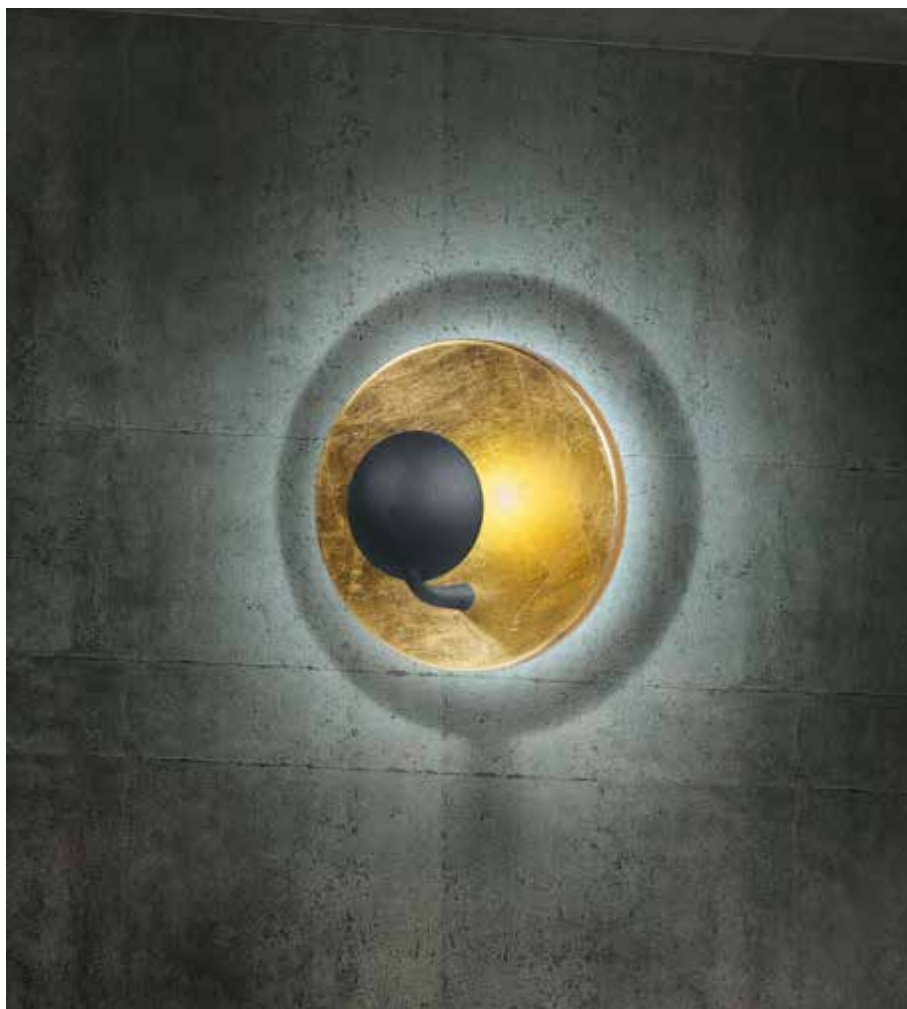



CHIROS

Metall, goldfarbig, Glas satiniert · metal, gold, satinated glass ·
 metale, or, verre satiné · metaal, goud, gesatineerd glas · metal, oro, vidrio satinado ·
 metallo, oro, vetro satinato · metal, aur, sticla satinata · metalli, kultaa, satinoitu lasi ·
 metal, złota, szkło satynowe



Wandleuchte · Wall lamp
 Ø 22 cm, ℓ 6,5 cm
 incl. 1 x SMD-LED, 8 W
 700 lm, 3.000 K

224110179



Deckenleuchte · Ceiling lamp
 Ø 32 cm, ℓ 6 cm
 incl. 1 x SMD-LED, 12 W, 1.100 lm
 incl. 1 x SMD-LED, 3,5 W, 350 lm
 3.000 K

624110279

MARIO

Metall, Weiß matt oder Schwarz matt · metal, white mat or black mat ·
metale, blanc mat ou noir mat · metaal, wit mat of mat zwart ·
metal, estera blanca o estera negra · metallo, bianco opaco o nero
opaco · metal, alb mat sau negru mat · metalli, valkoinen matto
tai musta matto · metal, biały mat lub czarny mat



Getrennt schaltbar ·
Separately switchable

Wandleuchte · Wall lamp

Ø 16 cm, √ 10,5 cm
incl. 1 x SMD-LED, 6 W
600 lm, 3.000 K
incl. 1 x SMD-LED, 2,3 W
200 lm, 3.000 K

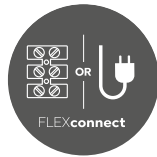

Seite/page 648



378

222370231 | Weiß matt · white mat
222370232 | Schwarz matt · black mat

LUIGI

Metall, Weiß matt oder Schwarz matt · metal, white mat or black mat ·
metale, blanc mat ou noir mat · metaal, wit mat of mat zwart ·
metal, estera blanca o estera negra · metallo, bianco opaco o nero
opaco · metal, alb mat sau negru mat · metalli, valkoinen matto
tai musta matto · metal, biały mat lub czarny mat



Getrennt schaltbar ·
Separately switchable

Wandleuchte · Wall lamp

↑ 20 x 13,5 cm, √ 11 cm
incl. 1 x SMD-LED, 5 W
500 lm, 3.000 K
incl. 1 x SMD-LED, 2,3 W
200 lm, 3.000 K



Seite/page 648



222270231 | Weiß matt · white mat
222270232 | Schwarz matt · black mat



MARRIOT

Nickel matt oder goldfarbig, Stoffschirm · nickel mat or gold, fabric shade ·
 nickel mat ou or, abat-jour tissu · nikkell mat of goud, Stoffen kap · níquel mate o oro, Pantalla de tela ·
 nichel opaco o oro, paralume in tessuto · nichel mat sau aur, abajur textil ·
 harjattu teräs tai kultaa, kangas varjostin · nikiel mat lub złota, Klosz z materiału

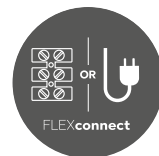

Seite/page 648



07 | Nickel matt · nickel mat



79 | goldfarbig · gold



Getrennt schaltbar ·
 Separately switchable

Wandleuchte · Wall lamp
 ↓ 30,8 x 14 cm, ∅ 17,6 cm
 incl. 1 x SMD-LED, 3,1 W
 310 lm, 3.000 K
 excl. 1 x E14, max. 40 W



271470207
 271470279



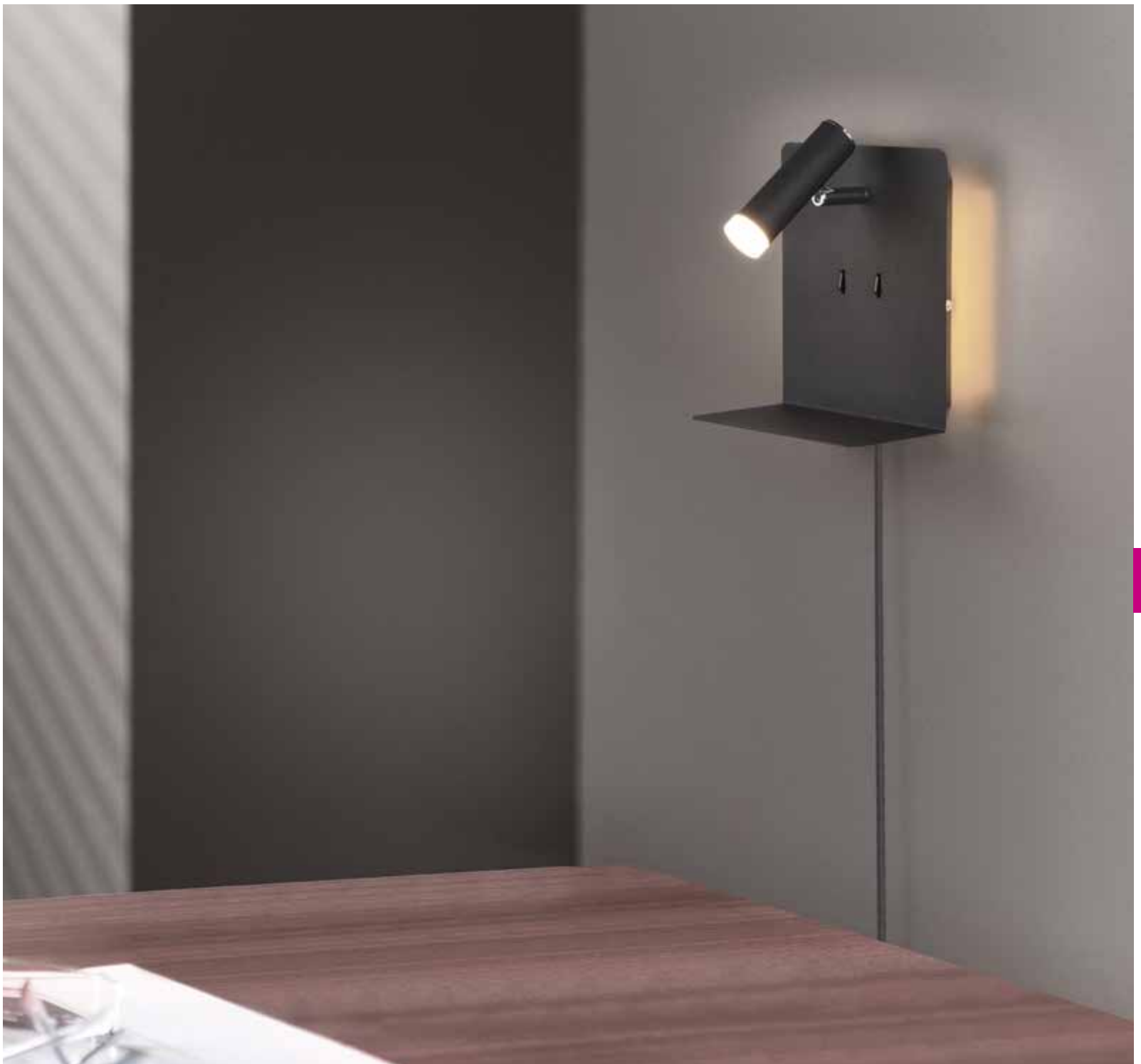

ELEMENT

Metall · metal ·
metale · metaal · metal · metallo ·
metal · metalli · metal · metal



USB Anschluss mit Ladefunktion ·
Recharging USB connection



Getrennt schaltbar ·
Separately switchable



indirekte Beleuchtung ·
indirect lighting



07 | Nickel matt · nickel mat



31 | Weiß matt · white mat

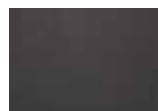

32 | Schwarz matt · black mat

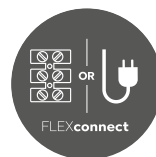

Seite/page 648

Wandleuchte · Wall lamp

↓ 20 x 16 cm, ∅ 14 cm
incl. 1 x SMD-LED, 3 W
240 lm, 3.000 K
incl. 2 x SMD, 1,5 W
2 x 120 lm, 3.000 K



222570207
222570231
222570232

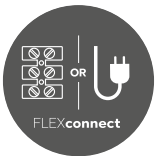

Seite/page 648



1x

2x

3x





JORDAN

Nickel matt, Weiß matt oder Schwarz matt, Acryl · nickel mat, white mat or black mat, acryl ·
 nickel mat, blanc mat ou noir mat, acryl · nikkel mat, wit mat of mat zwart, acryl ·
 níquel mate, estera blanca o estera negra, acrílico · nichel opaco, bianco opaco o nero opaco, acrílico ·
 nichel mat, alb mat sau negru mat, acrilic · harjattu teräs, mattavalkoinen tai mattamusta, akryyli ·
 nikiel mat, biały mat lub czarny mat, akryl



Getrennt schaltbar ·
 Separately switchable



07 | Nickel matt · nickel mat



31 | Weiß matt · white mat



32 | Schwarz matt · black mat

Wandleuchte · Wall lamp

Ø 15 cm, √ 12 cm
 incl. 1 x SMD-LED, 5 W
 550 lm, 3.000 K
 incl. 1 x SMD-LED, 2 W
 200 lm, 3.000 K



229210207
 229210231
 229210232



LOUIS

Metall · metal ·
metale · metaal · metallo · metal · metalli · metal · metal

Wandleuchte · Wall lamp
 ↑ 10 x 10 cm, ↗ 10 cm
 incl. 1 x OSRAM-LED, 4,3 W
 430 lm, 3.000 K



223310105
 223310131
 223310132



05 | Aluminium gebürstet · brushed aluminium



31 | Weiß matt · white mat



32 | Schwarz matt · black mat



LACAPO

Metall · metal ·
metale · metaal · metallo · metal · metalli · metal

Wandleuchte · Wall lamp
↔ 10,5 cm, ↑ 6 cm, ↗ 15 cm
incl. SMD-LED, 4,3 W
430 lm, 3.000 K



223410107
223410131
223410132

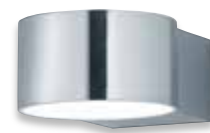

07 | Nickel matt · nickel mat



31 | Weiß matt · white mat



32 | Schwarz matt · black mat



MIGUEL

Metall, Weiß matt oder Schwarz matt · metal, white mat or black mat ·
 metale, blanc mat ou noir mat · metaal, wit mat of mat zwart · metal, estera blanca o estera negra ·
 metallo, bianco opaco o nero opaco · metal, alb mat sau negru mat · metalli, valkoinen matto tai musta matto · metal,
 biały mat lub czarny mat

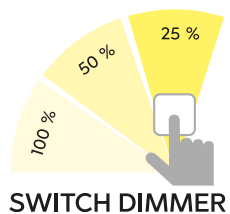

31 | Weiß matt · white mat



32 | Schwarz matt · black mat

Wandleuchte · Wall lamp
 ↔ 20,5 x 16,5 cm, ∩ 8,3 cm
 incl. SMD-LED, 2 x 6 W
 2 x 500 lm, 3.000 K



224910231
224910232



MELVIN

Metall, Schwarz matt oder Nickel antik · metal, black mat or nickel antique ·
 metale, noir mat ou nickel antique · metaal, mat zwart of antiek nikkel ·
 metal, estera negra o níquel antiguo · metallo, nero opaco o nickel anticato ·
 metal, negru mat sau nichel antic · metalli, mattamusta tai antiikkiteräs ·
 metal, czarny mat lub aikiel antyczny

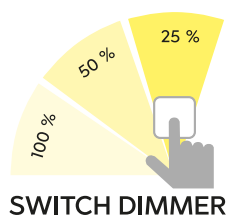

32 | Schwarz matt · black mat

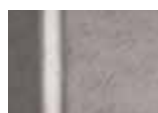

67 | Nickel antik · nickel antique

Wandleuchte · Wall lamp
 ↑ 8,5 x 11 cm, ↗ 10 cm
 incl. OSRAM-LED, 4,3 W
 430 lm, 3.000 K



223910132
223910167



CONCHA

rostfarbig, Weiß matt oder Anthrazit · rusty, white mat or anthracite ·
 rouille, blanc mat ou antracite · roestkleur, wit mat of antraciet · óxido, estera blanca o antracita ·
 ruggine, bianco opaco o antracite · ruginiu, alb mat sau antracit · rustiikki, mattavalkoinen tai antrasiitti ·
 miedź, biały mat lub antrycyt

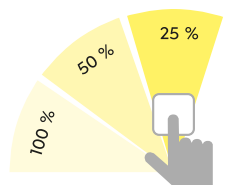

SWITCH DIMMER



24 | rostfarbig · rusty

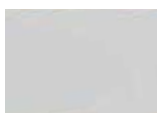

31 | Weiß matt · white mat

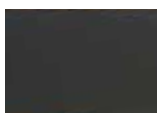

42 | Anthrazit · anthracite



Wandleuchte · Wall lamp
 ↔ 28 x 8 cm, √ 4,5 cm
 incl. 2 x SMD-LED, 6 W
 2 x 600 lm, 3.000 K



225172924
 225172931
 225172942



Wandleuchte · Wall lamp
 ↔ 47 x 8 cm, √ 4,5 cm
 incl. 2 x SMD-LED, 9 W
 2 x 900 lm, 3.000 K



225174724
 225174731
 225174742



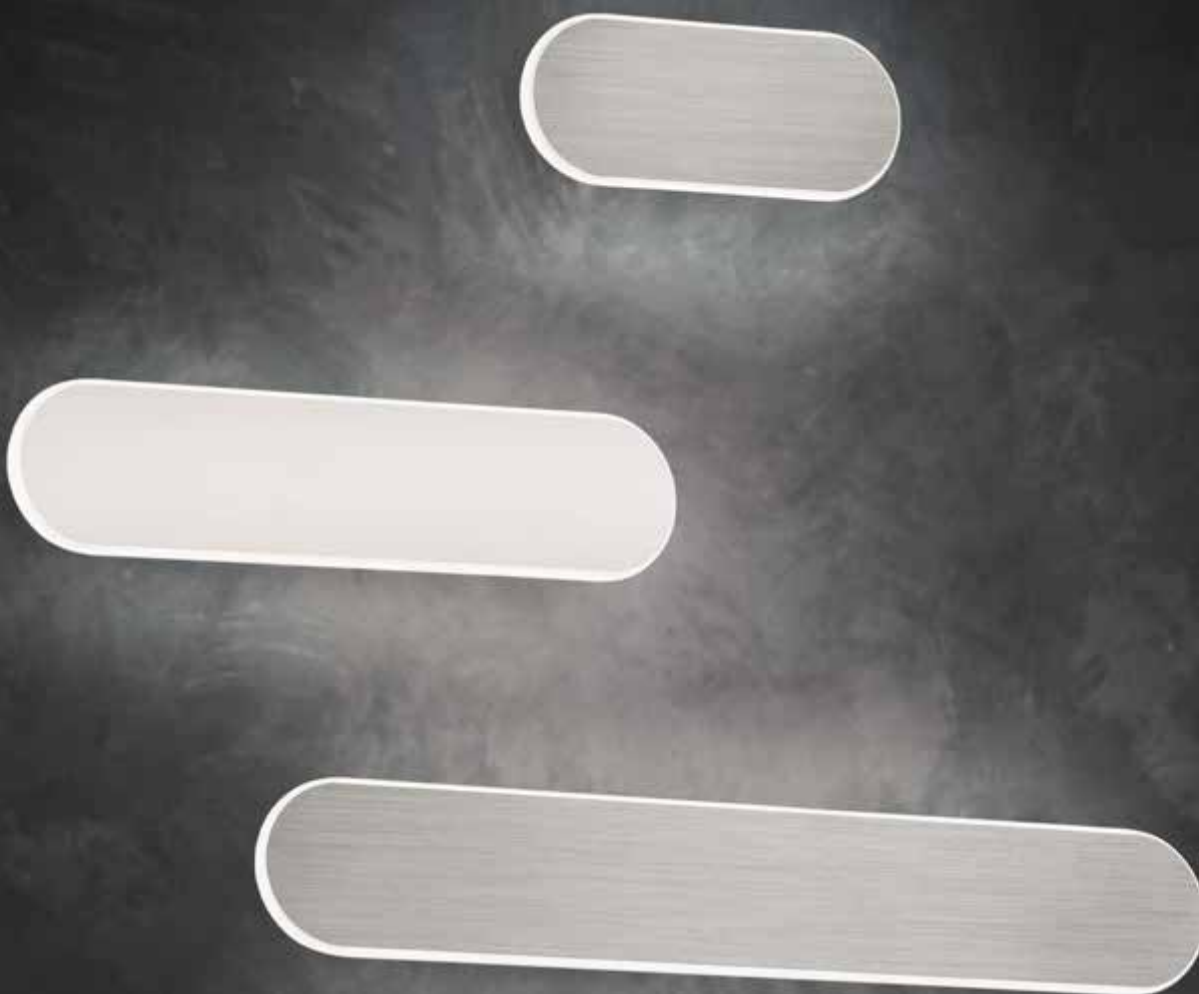

DIP SWITCH

Lichtfarben direkt an der Leuchte einstellbar · Colours directly adjustable at the lamp ·
 Les couleurs de la lumière peuvent être réglées directement sur le luminaire ·
 Lichtkleuren direct instelbaar op de lamp · Tonalidades de luz ajustables directamente en la lámpara ·
 Colori della luce regolabili direttamente sulla lampada · Culori ale luminii reglabile direct de la bec ·
 Valon väri asetettävissa suoraan valaisimesta · Barwy światła można ustawić bezpośrednio na oprawie



Wandleuchte · Wall lamp

↔ 20 x 8 cm, √ 4,8 cm
 incl. SMD-LED, 8,5 W
 850 lm, 2.700 + 4.000 + 6.000 K



225271007
 225271031



Wandleuchte · Wall lamp

↔ 35 x 8 cm, √ 4,8 cm
 incl. SMD-LED, 14 W
 1.400 lm, 2.700 + 4.000 + 6.000 K



225271507
 225271531



Wandleuchte · Wall lamp

↔ 50 x 8 cm, √ 4,8 cm
 incl. SMD-LED, 18 W
 1.800 lm, 2.700 + 4.000 + 6.000 K



225272007
 225272031



07 | Nickel matt · nickel mat

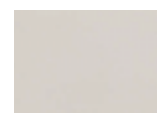

31 | Weiß matt · white mat



CARLO

Metall, Nickel matt oder Weiß matt · metal, nickel mat or white mat ·
 metale, nickel mat ou blanc mat · metaal, nikkel mat of wit mat · metal, níquel mate o estera blanca · metallo, nichel opaco o bianco opaco ·
 metal, nichel mat sau alb mat · metalli, harjattu teräs tai mattavalkoinen · metal, nikiel mat lub biały mat

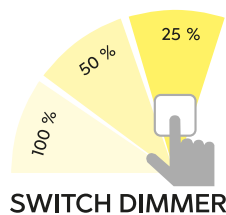
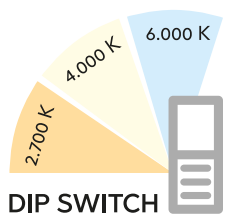

2.700 K



4.000 K



6.000 K

PLATON

Aluminium gebürstet, Acryl · brushed aluminium, acryl · aluminium balayé, acryl · geborsteld aluminium, acryl · aluminio pulido, acrílico · alluminio spazzolato, acrilico · aluminiu lucios, acrilic · harjattu alumiini, akryyli · aluminium szczotkowane, akryl



Wandleuchte · Wall lamp

↔ 13 x 18 cm, ∇ 9 cm
incl. 1 x SMD-LED, 4,3 W
430 lm, 3.000 K



274670105



Wandleuchte · Wall lamp

↔ 30 x 18 cm, ∇ 11 cm
incl. 2 x SMD-LED, 4,3 W
2 x 430 lm, 3.000 K



274670205



TRINITY

Aluminium gebürstet, Acryl · brushed aluminium, acryl · aluminium balayé, acryl · geborsteld aluminium, acryl · aluminio pulido, acrílico · alluminio spazzolato, acrilico · aluminiu lucios, acrilic · harjattu alumiini, akryyli · aluminium szczotkowane, akryl



Lichtfarbe einstellbar ·
Adjustable light color



3.000 K



4.000 K



5.500 K

Wandleuchte · Wall lamp

↑ 30 x 20 cm, ∇ 7 cm
incl. SMD-LED, 10 W
800 lm, 3.000+4.000+5.500 K



274813005



ABERDEEN

Nickel matt · nickel mat ·
nickel mat · nikkell mat · níquel mate ·
nichel opaco · nichel mat · harjattu teräs · nikiel mat



Wandleuchte · Wall lamp

↔ 20 cm, ↓ 8 cm, ↗ 7 cm
incl. 6 x SMD-LED, 1 W
6 x 100 lm, 3.000 K



225610607



WALES

Nickel matt · nickel mat ·
nickel mat · nikkell mat · níquel mate ·
nichel opaco · nichel mat · harjattu teräs · nikiel mat



Wandleuchte · Wall lamp

↔ 9 cm, ↓ 9 cm, ↗ 5,8 cm
incl. 2 x SMD-LED, 3,2 W
2 x 300 lm, 3.000 K



225510207





CUBE

Beton · concrete ·
 béton · beton · hormigón ·
 cemento · beton · betoni · beton

Empfohlen:
 recommended: LED GU10, 5 W
 400 lm, 3.000 K



956-55



Deckenleuchte · Ceiling lamp
 ↓ 15 cm, ↔ 10 x 10 cm
 excl. 1 x GU10, max. 35 W



606600178



Wandleuchte · Wall lamp
 ↓ 15 x 10 cm, ↗ 9 cm
 excl. 2 x GU10, max. 35 W



206600278



ADRIANO

Aluminium gebürstet oder Weiß · brushed aluminium or white ·
 aluminium balayé ou blanc · geborsteld aluminium of wit ·
 aluminio pulido o blanco · alluminio spazzolato o bianco ·
 aluminiu lucios sau alb · harjattu alumiini tai valkoinen ·
 aluminium szczotkowane lub biały



01 | Weiß · white



05 | Aluminium gebürstet · brushed aluminium

Wandleuchte · Wall lamp

↔ 30 x 6 cm, ∇ 8 cm

incl. 2 x SMD-LED, 3,1 W

2 x 310 lm, 3.000 K



220810201

220810205



ZORRO

Nickel matt, Weiß matt oder Schwarz matt · nickel mat, white mat or black mat ·
 nickel mat, blanc mat ou noir mat · nikkel mat, wit mat of mat zwart ·
 níquel mate, estera blanca o estera negra · nichel opaco, bianco opaco o nero opaco ·
 nichel mat, alb mat sau negru mat · harjattu teräs, valkoinen matto tai musta matto ·
 nikiel mat, biały mat lub czarny mat



07 | Nickel matt · nickel mat



31 | Weiß matt · white mat



32 | Schwarz matt · black mat



Wandleuchte · Wall lamp
 ↔ 18 x 14,5 cm, √ 6,5 cm
 incl. 1 x SMD-LED, 6,5 W
 500 lm, 3.000 K

223210107
223210131
223210132



Wandleuchte · Wall lamp
 ↔ 40 x 18 cm, √ 6,5 cm
 incl. 1 x SMD-LED, 13 W
 1.000 lm, 3.000 K

223210231
223210232

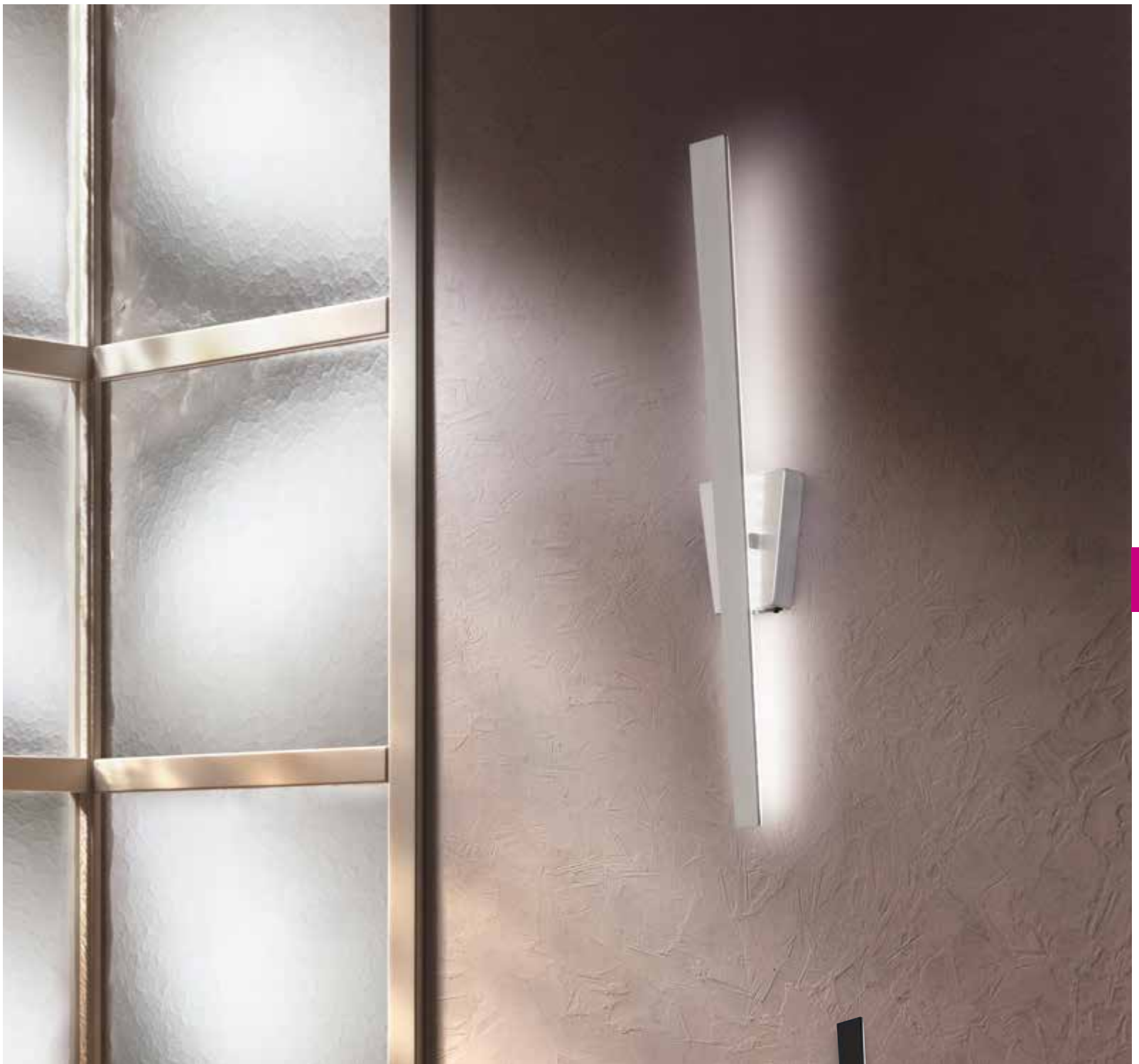

ZITA

Nickel matt, Weiß matt oder Schwarz matt · nickel mat, white mat or black mat ·
 nickel mat, blanc mat ou noir mat · nikkell mat, wit mat of mat zwart ·
 níquel mate, estera blanca o estera negra · nichel opaco, bianco opaco o nero opaco ·
 nichel mat, alb mat sau negru mat · harjattu teräs, valkoinen matto tai musta matto ·
 nikiel mat, biały mat lub czarny mat

Wandleuchte · Wall lamp

↑ 60 x 10 cm, ↗ 6,5 cm
 incl. 1 x SMD-LED, 6 W
 480 lm, 3.000 K



225870107 | Nickel matt · nickel mat

225870132 | Schwarz matt · black mat





CUADRO

Altmessing oder Nickel matt · old brass or nickel mat ·
 laiton fumé ou nickel mat · oud brons of nikkel mat · bronze viejo o níquel mate ·
 ottone invecchiato o nichel opaco · bronz antic sau nichel mat ·
 antiikkimessinki tai harjattu teräs · patyna lub nikiel mat

Wandleuchte · Wall lamp
 ↔ 48 x 10,5 cm, ∇ 10 cm
 incl. 1 x SMD-LED, 8 W
 600 lm, 3.000 K



225210104 | Altmessing · old brass
 225210107 | Nickel matt · nickel mat



CURTIS

Altmessing, Nickel matt oder Messing matt · old brass, nickel mat or brass mat ·
 laiton fumé, nickel mat ou laiton mat · oud brons, nikkel mat of messing mat · bronce viejo, níquel mate o bronce mate ·
 ottone invecchiato, nichel opaco o ottone satinato · bronz antic, nichel mat sau bronz mat · antiikkimessinki,
 harjattu teräs tai mattamessinki · patyna, nikiel mat lubmosiędz mat

 Integrierter Dimmer ·
 Integrated dimmer



Wandleuchte · Wall lamp
 ↔ 18 cm, ↗ max. 35 cm
 incl. SMD-LED, 4 W
 380 lm, 3.000 K



279770104
 279770107
 279770108



QUINTA

rostfarbig, Glas alabasterfarbig · rusty, alabaster-coloured glass ·
 rouille, verre couleur albâtre · roestkleur, albastkleurig glas · óxido, vidrio de color alabastro ·
 ruggine, vetro colore alabastro · ruginiu, sticla culoare alabastru · rustiikki, lasi alabasteri väri · miedź, szkło alabaster kolor



Deckenleuchte · Ceiling lamp
 Ø 33 cm, ↓ 20 cm
 excl. 2 x E27, max. 42 W



608100224



Deckenleuchte · Ceiling lamp
 Ø 42 cm, ↓ 32 cm
 excl. 3 x E27, max. 60 W



608100324



REPOSA

rostfarbig antik, Glas matt · antique rust, mat glass ·

rouille antique, verre mat · roestkleur antiek, mat glas · oxido, vidrio mate ·

ruggine anticato, vetro sabbaiato · ruginiu antic, sticla mata · rustiikki, mattalasi · antyczny rdzawy, szkło matowane



Deckenleuchte · Ceiling lamp
 Ø 80 cm, ↓ 10,5 cm
 incl. 15 x SMD-LED, 1,1 W
 15 x 115 lm, 3.000 K



622811528

FACELLA

rostfarbig, Glas alabasterfarbig · rusty, alabaster-coloured glass ·
rouille, verre couleur albâtre · roestkleur, albastkleurig glas ·
óxido, vidrio de color alabastro · ruggine, vetro colore alabastro ·
ruginiu, sticla culoare alabastru · rustiikki, lasi alabasteri väri ·
miedz, szkło alabaster kolor

Empfohlen:

recommended: LED G9, 3 W
300 lm, 3.000 K



929-2300



Wandleuchte · Wall lamp

↓ 27 cm, ↔ 5,5 cm, ↗ 9 cm
excl. 1 x G9, max. 28 W



216070124



CONO

Nickel matt, Glas matt · nickel mat, mat glass ·
nickel mat, verre mat · nikkell mat, mat glas ·
níquel mate, vidrio mate · nichel opaco, vetro sabbiato ·
nichel mat, sticla mata · harjattu teräs, mattalasi ·
nikiel mat, szkło matowane

Empfohlen:

recommended: LED E14, 4 W
320 lm, 3.000 K



989-40



Wandleuchte · Wall lamp

↓ 35 cm, ↔ 10 cm, ↗ 15 cm
excl. 1 x E14, max. 60 W



2502211-07





CAMPO

rostfarbig, Scavo glas · rusty, scavo glass ·
rouille, verre scavo · roestkleur, scavo glas ·
óxido, vidrio scavo · ruggine, vetro scavo ·
ruginiu, sticla scavo · rustiikki, scavo-lasi ·
miedź, szkło scavo

Empfohlen:
recommended: Filament LED E14, 4,5 W
470 lm, 2.700 K



989-400



Wandleuchte · Wall lamp
↓ 44 cm, ↔ 12 cm, ↗ 16 cm
excl. 1 x E14, max. 40 W



200970124



MOONY

Stoffschirm · fabric shade ·
abat-jour tissu · Stoffen kap · Pantalla de tela ·
paralume in tessuto · abajur textil · kangas varjostin · Klosz z materiału



01 | Weiß · white



45 | Pastellblau · pastel blue



94 | Pastellrosa · pastel pink

Deckenleuchte · Ceiling lamp
Ø 40 cm, ↑ 20,5 cm
excl. 3 x E27, max. 10 W



602300301
602300345
602300394



EMBASSY

Stoff Grau, Acryl · fabric grey, acryl ·
tissu gris, acryl · textiel grijs, acryl · tela gris, acrílico · tessuto grigio, acrilico ·
textil gri, acrilic · tekstiili harmaa, akryyli · tkanina popielaty, akryl



Deckenleuchte · Ceiling lamp
↔ 30 x 30 cm, ↓ 16 cm
excl. 2 x E14, max. 60 W



603800287



Deckenleuchte · Ceiling lamp
↔ 50 x 50 cm, ↓ 17 cm
excl. 4 x E27, max. 60 W



603800487

BOLDER

Metall, Weiß matt oder Schwarz matt · metal, white mat or black mat ·
metale, blanc mat ou noir mat · metaal, wit mat of mat zwart ·
metal, estera blanca o estera negra · metallo, bianco opaco o
nero opaco · metal, alb mat sau negru mat · metalli, valkoinen
matto tai musta matto · ametal, biały mat lub czarny mat



Wandleuchte · Wall lamp

↔ 35 cm, ↑ 29 cm, ↗ max. 150 cm
excl. 1 x E27, max. 40 W



200300131 | Weiß matt · white mat

200300132 | Schwarz matt · black mat



LINE

Metall, Weiß matt oder Schwarz matt · metal, white mat or black mat ·
metale, blanc mat ou noir mat · metaal, wit mat of mat zwart ·
metal, estera blanca o estera negra · metallo, bianco opaco o
nero opaco · metal, alb mat sau negru mat · metalli, valkoinen
matto tai musta matto · ametal, biały mat lub czarny mat



Wandleuchte · Wall lamp

↔ 5,5 cm, ↑ 25 cm, ↗ max. 150 cm
excl. 1 x E27, max. 40 W



200200131 | Weiß matt · white mat

200200132 | Schwarz matt · black mat



Empfohlen:
recommended: Filament LED E27, 6 W
190 lm, 3.000 K



988-654



BALDO

Metall, Weiß matt oder Schwarz matt, Stoffschirm · metal, white mat or black mat, fabric shade ·
 metale, blanc mat ou noir mat, abat-jour tissu · metaal, wit mat of mat zwart, Stoffen kap ·
 metal, estera blanca o estera negra, Pantalla de tela · metallo, bianco opaco o nero opaco, paralume in tessuto ·
 metal, alb mat sau negru mat, abajur textil · metalli, valkoinen matto tai musta matto, kangas varjostin ·
 metal, biały mat lub czarny mat, Klosz z materiału

Wandleuchte · Wall lamp

↔ 28 cm, ↓ 28,3 cm, ↗ max. 150 cm,
 excl. 1 x E27, max. 40 W



200600131 | Weiß matt · white mat

200600132 | Schwarz matt · black mat



ROMA



Wandleuchte · Wall lamp

↔ 24,5 x 9,5 cm, √ 12 cm
excl. 1 x E14, max. 28 W



201000101



Überstreichbare Gipsleuchten ·

Gypsum lights that can be painted · Lampes en gypse à peindre ·
overschilderbare gipslampen · Lámparas de yeso que pueden
pintarse · Le lampade in gesso possono essere verniciate ·
Lámpi de ipsos, ce pot fi vopsite · Maalattava kipsivalaisin ·
Oświetlenie gipsowe, które można pomalować

ZAZOU



Wandleuchte · Wall lamp

↑ 16,5 cm, ↔ 7,5 cm, √ 7 cm
excl. 2 x GU10, max. 10 W



201100201





LILLY

Überstreichbare Gipsleuchten · Gypsum lights that can be painted ·
 Lampes en gypse à peindre · overschilderbare gipslampen ·
 Lámparas de yeso que pueden pintarse · Le lampade in gesso possono essere verniciate ·
 Lāmpi de ipsos, ce pot fi vopsite · Maalattava kipsivalaisin ·
 Oświetlenie gipsowe, które można pomalować

Empfohlen:
 recommended: Filament LED E27, 7 W
 680 lm, 2.700 K



988-710

Empfohlen:
 recommended: Filament LED E27, 7 W
 680 lm, 2.700 K



986-710



Deckenleuchte · Ceiling lamp
 Ø 30 cm, ↓ 6 cm
 excl. 1 x E27, max. 40 W



603300101



Deckenleuchte · Ceiling lamp
 Ø 55 cm, ↓ 8 cm
 excl. 1 x E27, max. 40 W



603390101

MOSAIQUE

Glas Mosaik · glass mosaic · verre mosaïque · glas mozaiek · vidrio mosaico · vetro mosaico · sticla mozaic · lasi mosaiikki · szkło mozaika

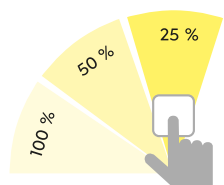

SWITCH DIMMER



Deckenleuchte · Ceiling lamp

Ø 40 cm, ↑ 10 cm

incl. SMD-LED, 20 W

1.800 lm, 3.000 K



673012489

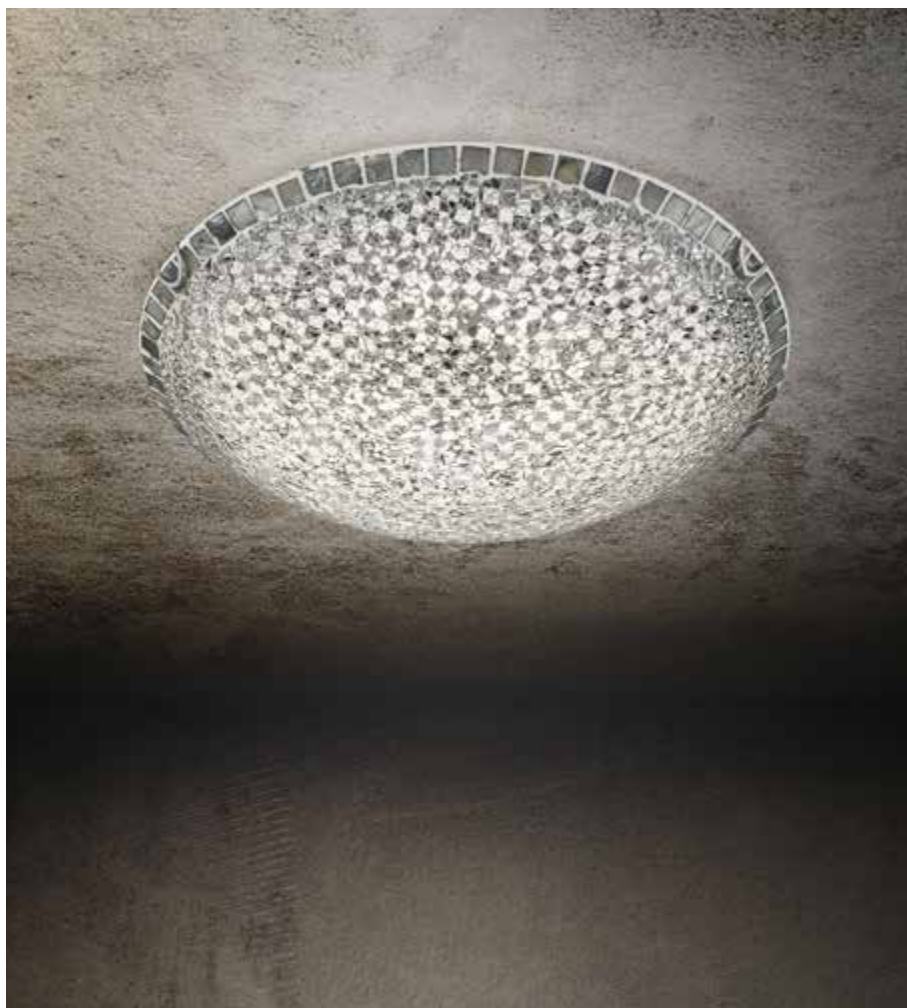

GEMMA

Dekorglas · glas decorated · verre décoré · decoratief glas · vidrio decorado · vetro decorato · sticla decorativa · ornamentilasi · szkło dekoracyjne

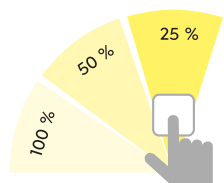

SWITCH DIMMER



Deckenleuchte · Ceiling lamp

Ø 30 cm, ↑ 9,5 cm

incl. SMD-LED, 12 W

900 lm, 3.000 K



673611201





COMTESS

Dekorglas · glas decorated ·
verre décoré · decoratief glas · vidrio decorado ·
vetro decorato · sticla decorativa · ornamenttilasi ·
szkło dekoracyjne

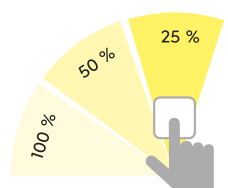

SWITCH DIMMER



Deckenleuchte · Ceiling lamp
Ø 40 cm, ↓ 12 cm
incl. SMD-LED, 20 W
1.800 lm, 3.000 K



656211800



COLINA

Dekorglas · glas decorated ·
 verre décoré · decoratief glas · vidrio decorado ·
 vetro decorato · sticla decorativa · ornamenttilasi · szkło dekoracyjne



Wandleuchte · Wall lamp
 ↔ 17 cm, ↓ 23 cm, ↗ 8,5 cm
 excl. 1 x E27, max. 40 W



200400100

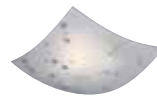

Deckenleuchte · Ceiling lamp
 ↔ 30 x 30 cm, ↓ 9 cm
 excl. 1 x E27, max. 40 W



600400100



Deckenleuchte · Ceiling lamp
 ↔ 40 x 40 cm, ↓ 9,5 cm
 excl. 2 x E27, max. 40 W



600400200



CHRISTOBAL

Chrom, Dekorglas Weiß · chrome, glas decorated white ·
 chrome, verre décoré blanc · chroom, decoratief glas wit · cromo, vidrio decorado blanco ·
 cromo, vetro decorato bianco · crom, sticla decorativa alb · kromi, ornamenttilasi valkoinen · chrom, szkło dekoracyjne biały



Wandleuchte · Wall lamp
 ↔ 30 x 15 cm, ↗ 9 cm
 excl. 1 x E27, max. 40 W



207700100



Deckenleuchte · Ceiling lamp
 Ø 30 cm, ↓ 9 cm
 excl. 1 x E27, max. 40 W



607700100



Deckenleuchte · Ceiling lamp
 Ø 40 cm, ↓ 10 cm
 excl. 2 x E27, max. 40 W



607700200



NORA

Dekorglas · glas decorated ·
 verre décoré · decoratief glas · vidrio decorado ·
 vetro decorato · sticla decorativa · ornamenttilasi · szkło dekoracyjne



Deckenleuchte · Ceiling lamp
 Ø 25 cm, ↑ 8 cm
 excl. 1 x E27, max. 40 W



602100100



Deckenleuchte · Ceiling lamp
 Ø 30 cm, ↑ 8,5 cm
 excl. 2 x E27, max. 40 W



602100200



CARBONADO

Dekorglas · glas decorated ·
 verre décoré · decoratief glas · vidrio decorado ·
 vetro decorato · sticla decorativa · ornamenttilasi · szkło dekoracyjne



Wandleuchte · Wall lamp
 ↔ 20 x 22 cm, ↗ 10 cm
 excl. 1 x E14, max. 40 W



202400106



Deckenleuchte · Ceiling lamp
 Ø 25 cm, ↓ 9,5 cm
 excl. 1 x E27, max. 40 W



602400106



Deckenleuchte · Ceiling lamp
 Ø 30 cm, ↓ 10,5 cm
 excl. 2 x E27, max. 40 W



602400206

ADRIAN

Glas alabasterfarbig · alabaster-coloured glass ·
verre couleur albâtre · albastkleurig glas ·
vidrio de color alabastro · vetro colore alabastro ·
sticla culoare alabastru · lasi alabasteri väri ·
szkło alabaster kolor



Deckenleuchte · Ceiling lamp

Ø 30 cm, ↑ 9 cm
excl. 1 x E27, max. 40 W



6105011-01



Deckenleuchte · Ceiling lamp

Ø 40 cm, ↑ 10 cm
excl. 2 x E27, max. 40 W



6105021-01



BULTO

Nickel matt, Glas matt · nickel mat, mat glass ·
nickel mat, verre mat · nikkell mat, mat glas ·
níquel mate, vidrio mate · nichel opaco, vetro sabbiato ·
nichel mat, sticla mata · harjattu teräs, mattalasi ·
nikiel mat, szkło matowane



Deckenleuchte · Ceiling lamp

Ø 29 cm, ↑ 11,7 cm
excl. 1 x E27, max. 60 W



6107011-07



Deckenleuchte · Ceiling lamp

Ø 40 cm, ↑ 14,3 cm
excl. 2 x E27, max. 60 W



6107021-07





CURVA

Nickel matt, Glas matt · nickel mat, mat glass ·
 nickel mat, verre mat · nikkel mat, mat glas · níquel mate, vidrio mate ·
 nichel opaco, vetro sabbaiato · nichel mat, sticla mata · harjattu teräs, mattalasi ·
 nikiel mat, szkło matowane



Deckenleuchte · Ceiling lamp
 ↔ 50 x 20 cm, ↓ 27 cm
 excl. 3 x E14, max. 40 W



605600307



Deckenleuchte · Ceiling lamp
 ↔ 72 x 28 cm, ↓ 27 cm
 excl. 5 x E14, max. 40 W



605600507

LANA

Glas Weiß matt oder alabasterfarbig · glass white mat or alabaster coloured · verre blanc mat ou couleur albâtre · glas wit mat of albastkleurig · vidrio estera blanca o Color alabastro · vetro bianco opaco o color alabastro · sticla alb mat sau Colorat în alabastru · lasi mattavalkoinen tai alabasterin värinen · szkło biały mat lub kolor alabastrowy



Deckenleuchte · Ceiling lamp

Ø 25 cm, ↓ 9 cm
excl. 1 x E27, max. 40 W



6196011-01



Deckenleuchte · Ceiling lamp

Ø 25 cm, ↓ 9 cm
excl. 1 x E27, max. 40 W



6196011-07



PRIMO

Metall, Glas · metal, glass ·
metale, verre · metaal, glas · metal, vidrio · metallo, vetro ·
metal, sticla · metalli, lasi · metal, szkło



01 | Weiß · white



07 | Nickel matt · nickel mat

Deckenleuchte · Ceiling lamp

Ø 30 cm, ↓ 7,5 cm
excl. 1 x E27, max. 60 W



6101011-01

6101011-07



CHICO

Glas · glass ·
verre · glas · vidrio · vetro ·
sticla · lasi · szkło



Deckenleuchte · Ceiling lamp

Ø 30 cm, ↓ 9 cm
excl. 1 x E27, max. 60 W



6160011-00



419

BUSA

Glas satiniert · satinated glass ·
verre satiné · gesatineerd glas · vidrio satinado ·
vetro satinato · sticla satinata · satinoitu lasi ·
szkło satynowe



Deckenleuchte · Ceiling lamp

↔ 23 x 23 cm, ↓ 8 cm
excl. 1 x E27, max. 40 W



601400106



MARTA

Chrom, Glas · chrome, glass ·
chrome, verre · chroom, glas · cromo, vidrio ·
cromo, vetro · crom, sticla · kromi, lasi · chrom, szkło



Wandleuchte · Wall lamp

↔ 20 x 20 cm, ∅ 8,5 cm
excl. 1 x E14, max. 40 W



2523011-01

420

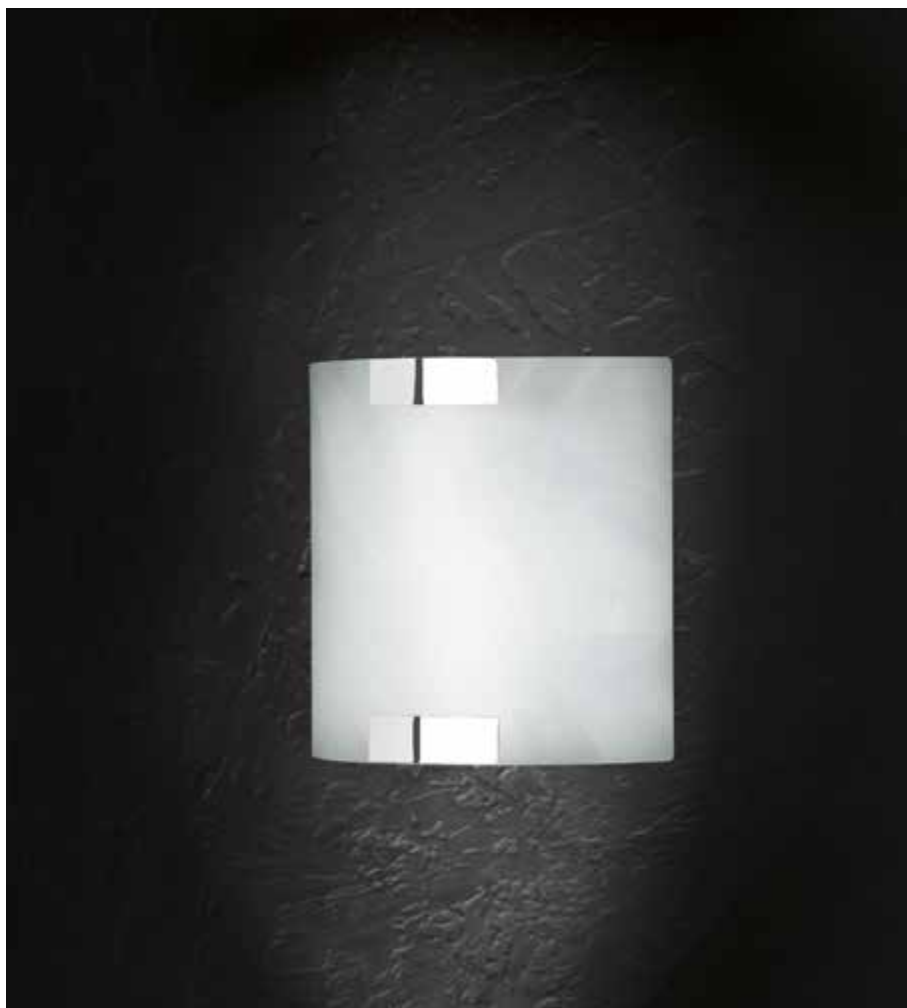

DIVO

Chrom, Glas · chrome, glass ·
chrome, verre · chroom, glas · cromo, vidrio ·
cromo, vetro · crom, sticla · kromi, lasi · chrom, szkło



Wandleuchte · Wall lamp

↔ 20 x 20 cm, ∅ 7,5 cm
excl. 1 x E14, max. 40 W



2522011-06





TOULON

Metall, Glas matt · metal, mat glass ·
 metale, verre mat · metaal, mat glas · metal, vidrio mate · metallo, vetro sabbato ·
 metal, sticla mata · metalli, mattalasi · metal, szkło matowane



Wandleuchte · Wall lamp
 ↔ 13 cm, ↑ 44 cm, ↗ 13 cm
 excl. 1 x E27, max. 60 W



204700101

LAON

Nickel matt · nickel mat ·
nickel mat · nikkell mat · níquel mate ·
nichel opaco · nichel mat · harjattu teräs · nikiel mat

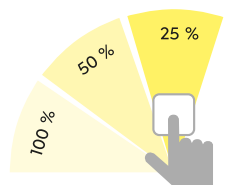

SWITCH DIMMER

Steckerleuchte · Plug light

↑ 40 cm, ↔ 4,7 cm, ↗ max. 16 cm
incl. 1 x LED GU10, 5 W
400 lm, 3.000 K



899670107



LIGARA

Kunststoff · plastic ·
plastique · kunststof · plástico ·
plastica · plastic · muovi · plastik

Steckerleuchte · Plug light

↑ 28 cm, ↔ 6,9 cm, ↗ max. 20 cm
excl. 1 x E14, max. 40 W



8911211-07



LEVISTO

Glas alabasterfarbig · alabaster-coloured glass ·
verre couleur albâtre · albastkleurig glas ·
vidrio de color alabastro · vetro colore alabastro ·
sticla culoare alabastru · lasi alabasteri väri ·
szkło alabaster kolor

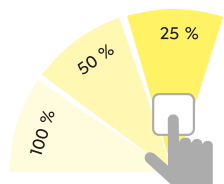

SWITCH DIMMER

Steckerleuchte · Plug light

↑ 40 cm, ↔ 4,7 cm, ↗ max. 22 cm
incl. 1 x LED E14, 6 W
470 lm, 3.000 K



891010107



423

FRED

Glas matt · mat glass ·
verre mat · mat glas · vidrio mate ·
vetro sabbaiato · sticla mata · mattalasi · szkło matowane

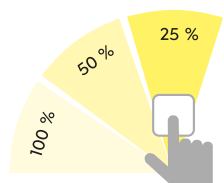

SWITCH DIMMER

Steckerleuchte · Plug light

↑ 40 cm, ↔ 4,7 cm, ↗ max. 20 cm
incl. 1 x LED G9, 3 W
300 lm, 3.000 K



891770107



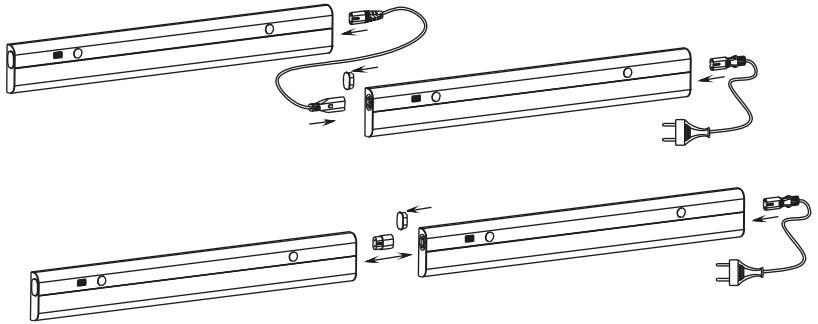
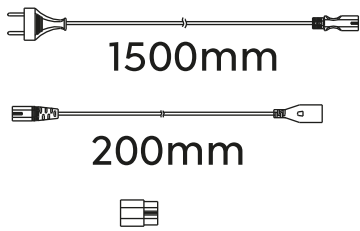

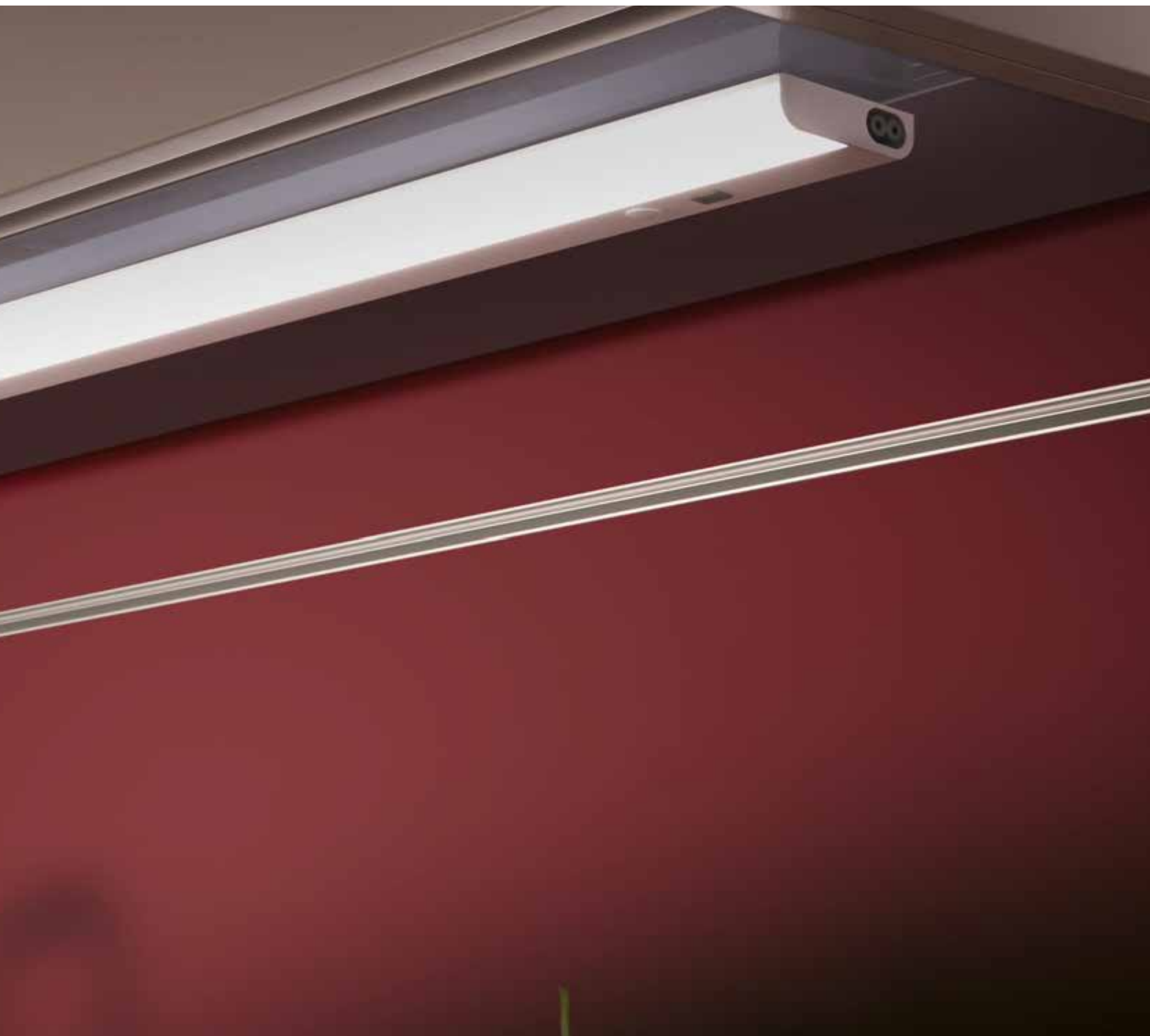

SIMEO

Kunststoff, Weiß · plastic, white ·
 plastique, blanc · kunststof, wit · plástico, blanco ·
 plastica, bianco · plastic, alb · muovi, valkoinen · plastik, biały



Gestensteuerung · Gesture control ·
 Contrôle gestuel · Gebaarbediening · Control gestual ·
 Controllo gestuale · Control prin gesturi/miscarea mainii ·
 Kädellä ohjattava liiketunnistin · Sterowana gestami



Unterbauleuchte · cabinet lighting
 ↔ 52,8 x 6,8 cm, ↓ 1,8 cm
 incl. SMD-LED, 10 W
 850 lm, 3.000 K



273271201



Unterbauleuchte · cabinet lighting
 ↔ 77 x 6,8 cm, ↓ 1,8 cm
 incl. SMD-LED, 15,5 W
 1.300 lm, 3.000 K



273271801



ARAGON

Kunststoff, Weiß oder titanfarbig · plastic, white or titan ·
 plastique, blanc ou titane · kunststof, wit of titaan · plástico, blanco o titán ·
 plastica, bianco o titano · plastic, alb sau titaniu · muovi, valkoinen tai titaani ·
 plastik, biały lub tytanowy



01 | Weiß · white



87 | titanfarbig · titanium-coloured



Unterbauleuchte · cabinet lighting
 ↔ 40 x 4 cm, ↓ 2 cm
 incl. 3 x SMD-LED, 1 W
 3 x 80 lm, 3.000 K



273170301
 273170387



Unterbauleuchte · cabinet lighting
 ↔ 55 x 4 cm, ↓ 2 cm
 incl. 4 x SMD-LED, 1 W
 4 x 80 lm, 3.000 K



273170401
 273170487



ALINO

Kunststoff, Weiß oder titanfarbig · plastic, white or titan ·
 plastique, blanc ou titane · kunststof, wit of titaan · plástico, blanco o titán ·
 plastica, bianco o titano · plastic, alb sau titaniu · muovi, valkoinen tai titaani ·
 plastik, biały lub tytanowy



01 | Weiß · white



87 | titanfarbig · titanium-coloured



Unterbauleuchte · cabinet lighting

↔ 34 x 7 cm, ↓ 2 cm
 incl. SMD-LED, 4 W
 350 lm, 3.000 K



272970401
 272970487



Unterbauleuchte · cabinet lighting

↔ 55 x 7 cm, ↓ 2 cm
 incl. SMD-LED, 7 W
 600 lm, 3.000 K



272970701
 272970787



ECCO

Nickel matt · nickel mat ·
 nickel mat · nikkell mat · níquel mate ·
 nichel opaco · nichel mat · harjattu teräs · nikiel mat

Unterbauleuchte · cabinet lighting

↔ 12,4 x 11,5 cm, ↑ 4,3 cm
 incl. 3 x SMD-LED, 3 W
 3 x 200 lm, 3.000 K



273370307 Set: 3 St./3 pc.





RAMON

Kunststoff · plastic ·
 plastique · kunststof · plástico ·
 plastica · plastic · muovi · plastik



Unterbauleuchte · cabinet lighting
 ↔ 28 x 2,5 cm, ↓ 4 cm
 incl. 1 x SMD-LED, 4 W
 350 lm, 3.000 K



273070401



Unterbauleuchte · cabinet lighting
 ↔ 51 x 2,5 cm, ↓ 4 cm
 incl. 1 x SMD-LED, 7 W
 600 lm, 3.000 K



273070701



Unterbauleuchte · cabinet lighting
 ↔ 84 x 2,5 cm, ↓ 4 cm
 incl. 1 x SMD-LED, 13 W
 1.100 lm, 3.000 K



273071301



Unterbauleuchte · cabinet lighting
 ↔ 114 x 2,5 cm, ↓ 4 cm
 incl. 1 x SMD-LED, 18 W
 1.500 lm, 3.000 K



273071801





430 - 505

Tisch- & Stehleuchten

Table- & floor lamps
Lampes de table & lampadaires
Tafel- & vloerlampen
Sobremesas y lámparas de pie
Lampade da tavolo e piantane
Veioze si lampadare
Pöytä- & lattia
Stołowe i podłogowe



BANGKOK

Metall, Marmor · metal, marble ·
 metale, marbre · metaal, marmer · metal, mármol ·
 metallo, marmo · metal, marmura · metalli, marmori ·
 metal, marmur



Integrierter Dimmer ·
 Integrated dimmer

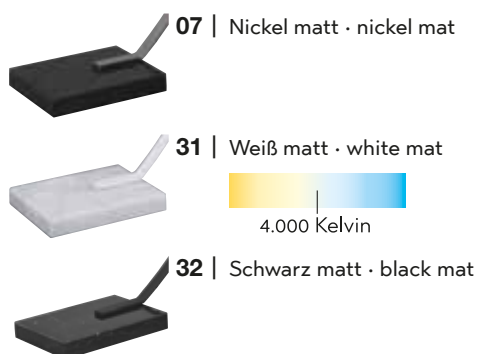

Stehleuchte · Floor lamp
 ↔ 22 x 23 cm, ↓ 180 cm, ↗ 127,5 cm
 incl. SMD-LED, 18 W
 1.400 lm, 3.000 K
(31 = 1.800 lm, 4.000 K)



426511807
 426511831
 426511832



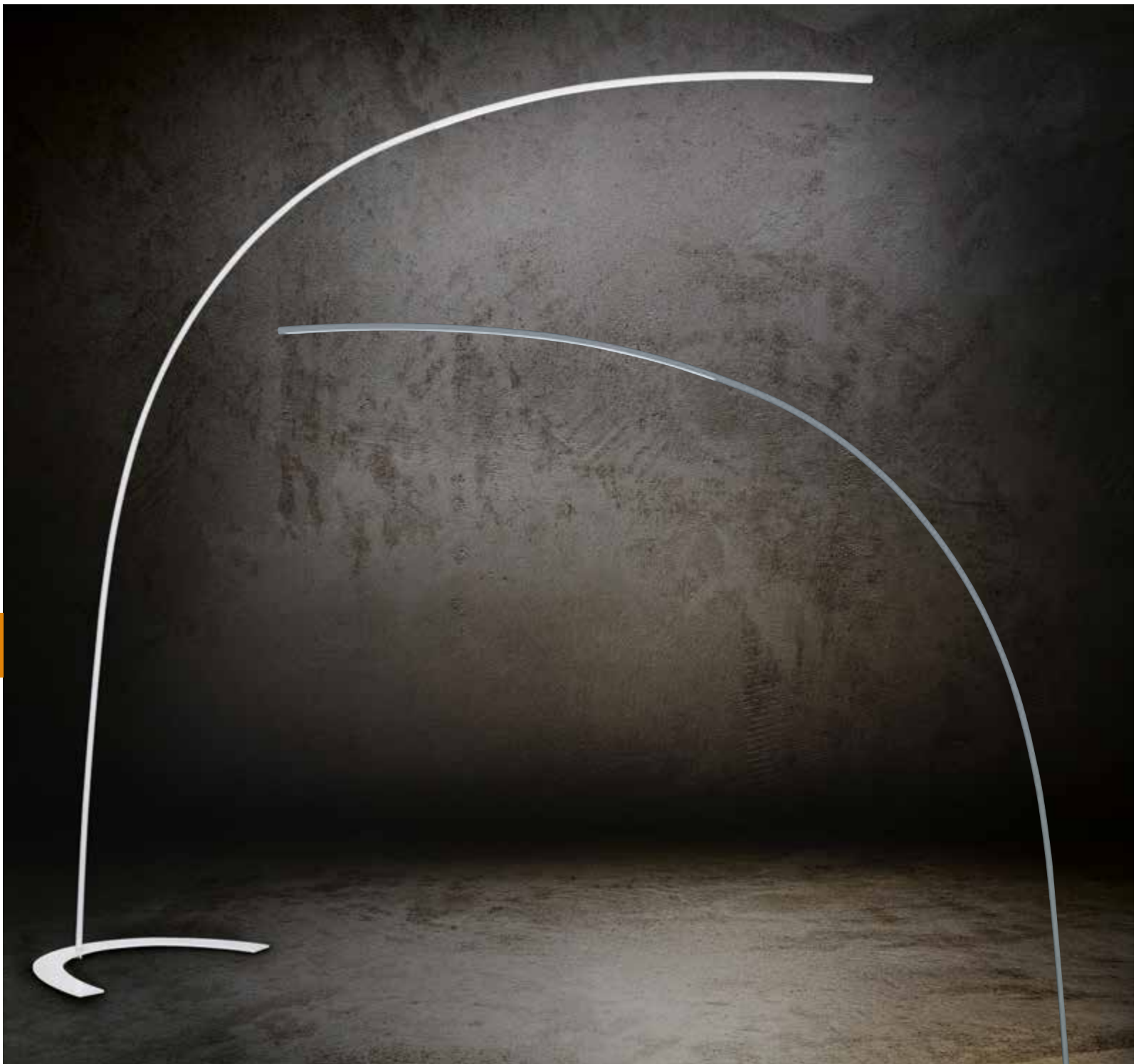

SHANGHAI

Metall · metal ·
metale · metaal · metallo · metal · metalli · metal



Integrierter Dimmer ·
Integrated dimmer



01 | Weiß · white



02 | Schwarz · black



87 | titanfarbig · titanium-coloured



Stehleuchte · Floor lamp
 ↑ 210 cm, ↔ 65 cm, ↗ 200 cm
 incl. SMD-LED, 18 W
 1.800 lm, 3.000 K



427511801
 427511802
 427511887





FLORESTAN

Nickel matt · nickel mat ·
 nickel mat · nikkell mat · níquel mate ·
 nichel opaco · nichel mat · harjattu teräs · nikiel mat



Integrierter Dimmer ·
 Integrated dimmer

Stehleuchte · Floor lamp
 ↑ 180 cm, Ø 32,5 cm, ∇ 100 cm
 incl. 4 x SMD-LED, 4,3 W
 4 x 430 lm, 3.000 K



429910107



SOLA

Chrom, Marmor, Acryl · chrome, marble, acryl ·
 chrome, marbre, acryl · chroom, marmer, acryl ·
 cromo, mármol, acrílico · cromo, marmo, acrilico ·
 crom, marmura, acrilic · kromi, marmori, akryyli ·
 chrom, marmur, akryl

Empfohlen:
 recommended: LED E14, 5 W
 400 lm, 3.000 K



983-60

Stehleuchte · Floor lamp
 ↑ 176 – 200 cm, ↗ 180 cm, Ø 40 cm
 excl. 1 x E27, max. 75 W



4200011-06



PONTE

Metall, Stoff · metal, fabric ·
 metale, tissu · metaal, textiel · metal, tela ·
 metallo, tessuto · metal, textil · metalli, tekstiili · metal, tkanina



31 | Weiß matt · white mat



32 | Schwarz matt · black mat



Stehleuchte · Floor lamp

↑ max. 168 cm, ↗ max. 125 cm, Ø 40 cm
 excl. 1 x E27, max. 60 W



401600131

401600132





TRACY

Metall, Schwarz matt, Stoffschirm · metal, black mat, fabric shade ·
 metale, noir mat, abat-jour tissu · metaal, mat zwart, Stoffen kap · metal, estera negra, Pantalla de tela ·
 metallo, nero opaco, paralume in tessuto · metal, negru mat, abajur textil · metalli, mattamusta, kangas varjostin ·
 metal, czarny mat, Klosz z materiału

Stehleuchte · Floor lamp
 ↓ 175 cm, Ø 40 cm, ↗ max. 105 cm
 excl. 1 x E27, max. 60 W



462100132



CLARK

Metall, Schwarz matt, Stoffschirm mehrfarbig · metal, black mat, fabric shade multicolor ·
 metale, noir mat, abat-jour tissu multicolore · metaal, mat zwart, Stoffen kap multicolor ·
 metal, estera negra, Pantalla de tela multicolor · metallo, nero opaco, paralume in tessuto multicolore ·
 metal, negru mat, abajur textil multicolor · metalli, mattamusta, kangas varjostin monivärinen ·
 metal, czarny mat, Klosz z materiału multi-kolor



Stehleuchte · Floor lamp
 ↓ 198 cm, ↔ 35 cm, ↗ 170 cm
 excl. 3 x E27, max. 60 W



401700317



PEREZ

Chrom, Marmor, Stoff · chrome, marble, fabric ·
 chrome, marbre, tissu · chroom, marmer, textiel ·
 cromo, mármol, tela · cromo, marmo, tessuto ·
 crom, marmura, textil · kromi, marmori, tekstiili ·
 chrom, marmur, tkanina

Stehleuchte · Floor lamp
 † 170 - 200 cm, † 170 cm, Ø 50 cm
 excl. 3 x E27, max. 60 W



421100301
 421100302



01 | Weiß · white



02 | Schwarz · black





CLAAS

Metall, Stoff · metal, fabric ·
 metale, tissu · metaal, textiel · metal, tela ·
 metallo, tessuto · metal, textil · metalli, tekstiili · metal, tkanina

 USB Anschluss mit Ladefunktion ·
 Recharging USB connection

 **07** | Nickel matt · nickel mat

 **32** | Schwarz matt · black mat



Stehleuchte · Floor lamp
 ↓ 160 cm, ↔ 40 cm, ↗ 40 cm
 excl. 1 x E27, max. 60 W



400400107
400400132



HOTEL

Metall, Stoffschirm · metal, fabric shade ·
 metale, abat-jour tissu · metaal, Stoffen kap ·
 metal, Pantalla de tela · metallo, paralume in tessuto ·
 metal, abajur textil · metalli, kangas varjostin ·
 metal, Klosz z materiału

Stehleuchte · Floor lamp
 ↑ 170 cm, Ø 40 cm, √ 35 cm
 excl. 1 x E27, max. 60 W
 excl. 1 x E14, max. 18 W



403900201
 403900208
 403900211



01 | Nickel matt, Schirm Weiß ·
 nickel mat, shade white



08 | Messing matt, Schirm Creme-Weiß ·
 brass mat, shade cream white



11 | Nickel matt, Schirm Grau ·
 nickel mat, shade grey





PARIS II

Nickel matt oder Messing matt · nickel mat or brass mat ·
 nickel mat ou laiton mat · nikkell mat of messing mat ·
 níquel mate o bronce mate · nichel opaco o ottone satinato ·
 nichel mat sau bronz mat · harjattu teräs tai mattamessinki ·
 nikiel mat lub mosiądz mat



07 | Nickel matt · nickel mat



08 | Messing matt · brass mat



Tischleuchte · Table lamp
 ↓ 58 cm, Ø 35 cm
 excl. 1 x E27, max. 60 W



500200107
 500200108



Stehleuchte · Floor lamp
 ↓ 160 cm, Ø 50 cm
 excl. 1 x E27, max. 60 W



400200107
 400200108





TANDORI

Nickel matt, Stoff · nickel mat, fabric ·
 nickel mat, tissu · nikkel mat, textiel · níquel mate, tela ·
 nichel opaco, tessuto · nichel mat, textil · harjattu teräs, tekstiili · nikiel mat, tkanina

1x ————— 2x ————— 3x



Getrennt schaltbar · Separately switchable
 Interrupteurs séparés · Gescheiden schakelbaar · Interruptores separados ·
 Interruttori separati · Intreruptoare separate · Erikseen kytkettävissä ·
 Oddzileny przełącznik



Tischleuchte · Table lamp
 ↓ 53 cm, Ø 25 cm
 incl. 3 x SMD-LED, 1,8 W
 3 x 150 lm, 3.000 K
 excl. 1 x E27, max. 40 W



575410207

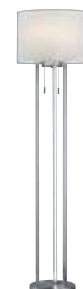

Stehleuchte · Floor lamp
 ↓ 156 cm, Ø 40 cm
 incl. 3 x SMD-LED, 5 W
 3 x 470 lm, 3.000 K
 excl. 1 x E27, max. 40 W



475410207





1x

2x

3x



Getrennt schaltbar · Separately switchable
 Interrupteurs séparés · Gescheiden schakelbaar ·
 Interruptores separados · Interruttori separati ·
 Interrupatoare separate · Erikseen kytkettävissä ·
 Oddzielny przełącznik



NANDOR

Metall, Stoff · metal, fabric ·
 metale, tissu · metaal, textiel · metal, tela ·
 metallo, tessuto · metal, textil · metalli, tekstiili · metal, tkanina

07 | Nickel matt · nickel mat

79 | goldfarbig · gold



Tischleuchte · Table lamp

‡ 62 cm, Ø 30 cm
 incl. 2 x SMD, 3 W
 2 x 300 lm, 3.000 K
 excl. 1 x E27, max. 40 W



575310307
 575310379



Stehleuchte · Floor lamp

‡ 160,5 cm, Ø 40 cm
 incl. 2 x SMD, 7 W
 2 x 600 lm, 3.000 K
 excl. 1 x E27, max. 60 W



475310307
 475310379



CANNES II

Chrom / Aluminium gebürstet, Acryl, Stoffschirm · chrome / brushed aluminium, acryl, fabric shade ·
 chrome / aluminium balayé, acryl, abat-jour tissu · chroom / geborsteld aluminium, acryl, Stoffen kap ·
 cromo / aluminio pulido, acrílico, Pantalla de tela · cromo / alluminio spazzolato, acrilico, paralume in tessuto ·
 crom / aluminiu lucios, acrilic, abajur textil · kromi / harjattu alumiini, akryyli, kangas varjostin ·
 chrom / aluminium szczotkowane, akryl, Klosz z materiału

1x ————— 2x ————— 3x



Stehleuchte · Floor lamp

↑ 165 cm, Ø 38 cm
 incl. SMD-LED, 15,5 W
 1.370 lm, 3.000 K
 excl. 1 x E27, max. 60 W



422970206

Getrennt schaltbar · Separately switchable · Interrupteurs séparés ·
 Gescheiden schakelbaar · Interruptores separados · Interruttori separati ·
 Intrerupatoare separate · Erikseen kytkettävissä · Oddzileny przełącznik





LINZ

Chrom, Stoffschirm, Schwarz/goldfarbig · chrome, fabric shade, black/gold ·
 chrome, abat-jour tissu, noir/or · chroom, Stoffen kap, zwart/goud ·
 cromo, Pantalla de tela, negro/oro · cromo, paralume in tessuto, nero/oro ·
 crom, abajur textil, negru/aur · kromi, kangas varjostin, musta/kultaa ·
 chrom, Klosz z materiału, czarny/złota



Stehleuchte · Floor lamp
 ↓ 210 cm, ↗ 165 cm
 excl. 1 x E27, max. 60 W



467400102



GENT

Holz, Stoffschirm, Schwarz/goldfarbig · wood, fabric shade, black/gold ·
 bois, abat-jour tissu, noir/or · hout, Stoffen kap, zwart/goud ·
 madera, Pantalla de tela, negro/oro · di legno, paralume in tessuto, nero/oro ·
 lemn, abajur textil, negru/aur · puu, kangas varjostin, musta/kultaa ·
 drewno, Klosz z materiału, czarny/złota



Stehleuchte · Floor lamp
 ↓ 110 - 150 cm, ↔ 80 cm
 excl. 1 x E27, max. 60 W



407400179



LIÈGE

Holz, Metall, Schwarz matt/goldfarbig · wood, metal, black mat/gold ·
 bois, métal, noir mat/or · hout, metaal, mat zwart/goud ·
 madera, metal, estera negra/oro · di legno, metallo, nero opaco/oro ·
 lemn, metal, negru mat/aur · puu, metalli, mattamusta/kultaa ·
 drewno, metal, czarny mat/złota



Tischleuchte · Table lamp
 ↓ 29 cm, ↔ 22,5 cm, ↗ 28 cm
 excl. 1 x E14, max. 40 W



507800132



Stehleuchte · Floor lamp
 ↓ 120 - 160 cm, ↔ 80 cm
 excl. 1 x E27, max. 60 W



407800132



TEXEL

Metall Schwarz matt/goldfarbig · metal black mat/gold ·
 metale noir mat/or · metaal mat zwart/goud · metal estera negra/oro ·
 metallo nero opaco/oro · metal negru mat/aur · metalli musta matto/kultaa ·
 metal czarny mat/złota



Tischleuchte · Table lamp
 ↑ 47,5 cm, Ø 16 cm
 incl. 1 x SMD-LED, 6,5 W
 660 lm, 3.000 K



574410179



Stehleuchte · Floor lamp
 ↑ 142,5 cm, Ø 25 cm
 incl. 1 x SMD-LED, 15 W
 1.450 lm, 3.000 K



474410179



LANCE

Metall, Chrom oder Schwarz, Glas rauchfarbig oder mehrfarbig ·
 metal, chrome or black, glass smoke or multicolor ·
 metals, chrome ou noir, verre fumé ou multicolore ·
 metaal, chrom of zwart, glas rookkleur of multicolor ·
 metal, cromo o negro, vidrio humo o multicolor ·
 metallo, cromo o nero, vetro fume' o multicolore ·
 metal, crom sau negru, sticla fumuriu sau multicolor ·
 metalli, kromi tai musta, lasi savu tai monivärinen ·
 metal, chrom lub czarny, szkło przydymiony lub multi-kolor

Stehleuchte · Floor lamp

↑ 156 cm, Ø 60 cm
 excl. 3 x E14, max. 28 W



403400317 | mehrfarbig · multicolor

403400354 | rauchfarbig · smoke



Chrom, Glas rauchfarbig ·
 chrome, glass smoke



Schwarz matt, Glas multicolor ·
 black mat, glass multicolor





Stufenlos dimmbar, Lichtfarbe stufenlos einstellbar ·
 infinitely dimmable, light color infinitely variable ·
 infiniment dimmable, couleur de lumière infiniment
 variable · traploos dimbaar, lichtkleur traploos
 instelbaar · sin etapas regulable, color de luz
 infinitamente variable · infinitamente dimmerabile,
 colore della luce infinitamente variabile ·
 variator de lumina fara trepte, cu intrerupator
 standard de lumina · portaaton himmennys,
 valon väri portaattomasti · bezstopniowe
 ściemnianie, jasny kolor bezstopniowo

458

SPLIT

Nickel matt · nickel mat ·
 nickel mat · nikkel mat · níquel mate ·
 nichel opaco · nichel mat · harjattu teräs · nikiel mat



Lichtfarbe stufenlos einstellbar ·
 Light color infinitely variable



Integrierter Dimmer ·
 Integrated dimmer



Memory Funktion ·
 Memory function

Stehleuchte · Floor lamp
 ↑ 181 cm, ↔ 33 cm, ↗ 43 cm
 incl. SMD-LED, 20 W
 2.000 lm, 3.000 - 6.500 K
 incl. 1 x SMD-LED, 3,5 W
 340 lm, 3.000 - 6.500 K



424910207





PILLAR

Chrom, Acryl · chrome, acryl ·
chrome, acryl · chroom, acryl · cromo, acrílico ·
cromo, acrílico · crom, acrílic · kromi, akryyli ·
chrom, akryl



RGBW Farbwechsler ·
RGBW Colorchanging



Integrierter Dimmer ·
Integrated dimmer



Stehleuchte · Floor lamp
↑ 150 cm, Ø 24 cm
incl. 1 x SMD-LED, 24 W
max. 2.000 lm, 3.000 K



423510101



-  **04** | Altmessing · old brass
-  **07** | Nickel matt · nickel mat
-  **08** | Messing matt · brass mat
-  **32** | Schwarz matt · black mat



BARRIE

Metall · metal ·
 metale · metaal · metal · metallo ·
 metal · metalli · metal

 Lichtfarbe einstellbar ·
 Adjustable light color

 Sensordimmer ·
 Sensor dimmer

 Memory Funktion ·
 Memory function



Stehleuchte · Floor lamp
 † 181 cm, Ø 30 cm, √ 70 cm
 incl. SMD-LED, 32 W, 4.000 lm
 incl. SMD-LED, 6 W, 600 lm
 2.700 + 4.000 K



424210304
 424210307
 424210308
 424210332



3.000 K

6.000 K





Dimmen und Lichtfarbe einstellen ·
Dimming and adjusting light color ·
Varier et choisir la couleur de la lumière ·
Dimmen en lichtkleur instellen ·
Atenuación y ajuste del color de la luz ·
Variare e scegliere il colore della luce ·
Variati lumina si ajustati culoarea luminii ·
Himmennys ja värilämpötilan säätö vakiokytkimellä ·
ściemniać i jasność ustawić



QUEBEC

Nickel matt oder Messing matt · nickel mat or brass mat ·
 nickel mat ou laiton mat · nikkell mat of messing mat ·
 níquel mate o bronz mate · nichel opaco o ottone satinato ·
 nichel mat sau bronz mat · harjattu teräs tai mattamessinki ·
 nikiel mat lub mosiądz mat

 Lichtfarbe stufenlos einstellbar ·
 Light color infinitely variable

 Integrierter Dimmer ·
 Integrated dimmer

 Memory Funktion ·
 Memory function



07 | Nickel matt · nickel mat



08 | Messing matt · brass mat

Stehleuchte · Floor lamp

↓ 180 cm, ↗ 50 cm
 incl. SMD-LED, 34 W
 3.000 lm, 3.000 - 6.000 K
 incl. SMD-LED, 5,5 W
 400 lm, 3.000 - 6.000 K



422710307
 422710308

ARANGO

Nickel matt oder Altmessing · nickel mat or old brass ·
nickel mat ou laiton fumé · nikkell mat of oud brons ·
níquel mate o bronce viejo · nichel opaco o ottone invecchiato ·
nichel mat sau bronz antic · harjattu teräs tai antiikkimessinki ·
nikiel mat lub patyna



Integrierter Dimmer ·
Integrated dimmer

Stehleuchte · Floor lamp

↑ 180 cm, Ø 31 cm
incl. 1 x SMD-LED, 20 W
1.750 lm, 3.000 K



429110104 | Altmessing · old brass

429110107 | Nickel matt · nickel mat



ARIZONA

Nickel matt oder Messing matt ·
nickel mat or brass mat ·
nickel mat ou laiton mat ·
nikkell mat of messing mat ·
níquel mate o bronce mate ·
nichel opaco o ottone satinato ·
nichel mat sau bronz mat ·
harjattu teräs tai mattamessinki ·
nikiel mat lub mosiądz mat



Sensordimmer ·
Sensor dimmer

Stehleuchte · Floor lamp

↑ 180 cm, Ø 25,5 cm, √ 40 cm
incl. SMD-LED, 20 W, 2.000 lm, 3.000 K
incl. 1 x SMD-LED, 5 W, 500 lm, 3.000 K



426410207 | Nickel matt · nickel mat

426410208 | Messing matt · brass mat





SANTO II

Metall, Glas alabasterfarbig · metal, alabaster-coloured glass ·
 metale, verre couleur albâtre · metaal, albastkleurig glas · metal, vidrio de color alabastro ·
 metallo, vetro colore alabastro · metal, sticla culoare alabastru · metalli, lasi alabasteri vâri ·
 metal, szkło alabaster kolor



Integrierter Dimmer ·
 Integrated dimmer



07 | Nickel matt · nickel mat



28 | rostfarbig antik · antique rust



Stehleuchte · Floor lamp

↑ 180 cm, Ø 25,5 cm, ∇ 40 cm

incl. 4 x SMD-LED, 4,5 W, 4 x 440 lm, 3.000 K

incl. 1 x SMD-LED, 4,5 W, 440 lm, 3.000 K



421910207

421910228



CHRIS

Chrom, Acryl mit Kristalleffekt · chrome, broken glass optic ·
 chrome, optique verre pilé · chroom, gebroken glas optiek ·
 cromo, efecto cristal roto · cromo, effetto ottico vetro rotto ·
 crom, aspect de sticla sparta · kromi, lasi efekti optiikka ·
 chrom, optyczne rozbite szkło



Deckenleuchte · Ceiling lamp

↓ 180 cm, ↗ 52 cm

incl. 1 x SMD-LED, 22 W, 2.000 lm, 3.000 K
 incl. 1 x SMD-LED, 3,8 W, 350 lm, 3.000 K



478310206



Deckenleuchte · Ceiling lamp

↓ 200,5 cm, ↔ 70 cm, ↗ 61 cm

incl. 5 x SMD-LED, 3,8 W
 5 x 350 lm, 3.000 K



478310506



BALOUBET

Chrom, Kunststoff/Metall · chrome, plastic/metal ·
 chrome, plastique/metale · chroom, kunststof/metaal ·
 cromo, plástico/metal · cromo, plastica/metallo ·
 crom, plastic/metal · kromi, muovi/metalli ·
 chrom, plastik/metal

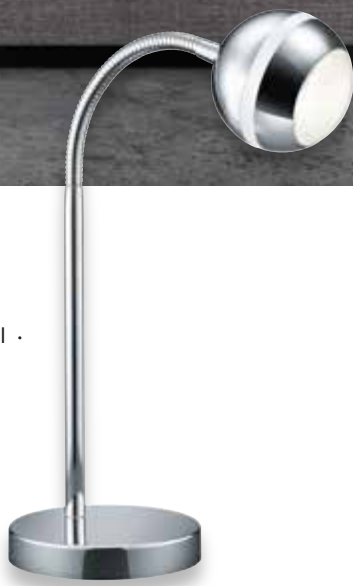

Deckenleuchte · Ceiling lamp
 ↓ 35 cm, ↗ 20 cm
 incl. 1 x SMD-LED, 3,8 W
 350 lm, 3.100 K



528210106



Deckenleuchte · Ceiling lamp
 ↓ 125 cm, ↗ 45 cm
 incl. 2 x SMD-LED, 3,8 W
 2 x 350 lm, 3.100 K



428210206



Tischleuchte · Table lamp
 ↓ 57 cm, ↔ 19 cm, ↗ 46 cm
 incl. SMD-LED, 12 W
 1.400 lm, 2.300 + 3.000 + 4.000 K



523310107
523310108
523310132



Stehleuchte · Floor lamp
 ↓ 145 cm, ↔ 25 cm, ↗ 50 cm
 incl. SMD-LED, 12 W
 1.400 lm, 2.300 + 3.000 + 4.000 K



423310107
423310108
423310132



MONZA

Metall · metal ·
 metale · metaal · metal ·
 metallo · metal · metalli · metal

 Lichtfarbe einstellbar ·
 Adjustable light color

 Sensordimmer ·
 Sensor dimmer

 **07** | Nickel matt · nickel mat

 **08** | Messing matt · brass mat

 **32** | Schwarz matt · black mat





BERGAMO

Nickel matt oder Messing matt · nickel mat or brass mat ·
nickel mat ou laiton mat · nikkell mat of messing mat ·
níquel mate o bronce mate · nichel opaco o ottone satinato ·
nichel mat sau bronz mat · harjattu teräs tai mattamessinki ·
nikiel mat lub mosiądz mat



Sensordimmer ·
Sensor dimmer



07 | Nickel matt · nickel mat



08 | Messing matt · brass mat



Tischleuchte · Table lamp
↓ 50 cm, ↗ 40 cm
incl. 1 x SMD-LED, 12 W
1.100 lm, 3.000 K



520910107
520910108



Stehleuchte · Floor lamp
↓ 135 cm, ↗ 50 cm
incl. 1 x SMD-LED, 12 W
1.100 lm, 3.000 K



420910107
420910108



VERONA

Nickel matt · nickel mat ·
nickel mat · nikkell mat · níquel mate · nichel opaco ·
nichel mat · harjattu teräs · nikiel mat



Sensordimmer · Sensor dimmer
Variateur tactile · Touchdimmer ·
Regulador con sensor · Touchdimmer ·
Variator cu senzor · Kosketushimmennin ·
Czujnik ściemniania ·



Stehleuchte · Floor lamp
↑ 126 cm, ↗ 60 cm
incl. 1 x SMD-LED, 12 W
1.100 lm, 3.000 K



420810107

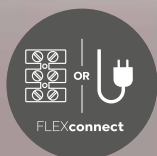

Seite/page 648

KAZAN

Nickel matt oder Schwarz matt · nickel mat or black mat ·
 nickel mat ou noir mat · nikkell mat of mat zwart ·
 níquel mate o estera negra · nichel opaco o nero opaco ·
 nichel mat sau negru mat · harjattu teräs tai musta matto ·
 nikiel mat lub czarny mat



07 | Nickel matt · nickel mat



32 | Schwarz matt · black mat



Wandleuchte · Wall lamp

Ø 14 cm, ↗ max. 55 cm
 incl. 1 x SMD, 8 W
 750 lm, 3.000 K



274770107
 274770132



Stehleuchte · Floor lamp

↑ 121,5 cm, ↔ 24 cm, ↗ max. 61,5 cm
 incl. 1 x SMD, 8 W
 750 lm, 3.000 K



474790107
 474790132





CALCIO

Nickel matt oder Messing matt · nickel mat or brass mat ·
 nickel mat ou laiton mat · nikkell mat of messing mat · níquel mate o bronze mate ·
 nichel opaco o ottone satinato · nichel mat sau bronz mat · harjattu teräs tai mattamessinki ·
 nikiel mat lub mosiądz mat



Integrierter Dimmer ·
 Integrated dimmer



07 | Nickel matt · nickel mat



08 | Messing matt · brass mat



Tischleuchte · Table lamp
 ↑ 43 cm, ↗ 50 cm
 incl. 1 x SMD-LED, 6 W
 560 lm, 3.000 K



572410107
 572410108



Stehleuchte · Floor lamp
 ↑ 120 - 140 cm, ↗ max. 71 cm
 incl. 1 x SMD-LED, 10 W
 1.000 lm, 3.000 K



422410107
 422410108





NARCOS

Nickel matt, Weiß matt oder Schwarz matt · nickel mat, white mat or black mat ·
 nickel mat, blanc mat ou noir mat · nikkell mat, wit mat of mat zwart · níquel mate, estera blanca o estera negra ·
 nichel opaco, bianco opaco o nero opaco · nichel mat, alb mat sau negru mat · harjattu teräs, valkoinen matto tai musta matto ·
 nikiel mat, biały mat lub czarny mat



4 fach TOUCH ·
4 level Touch function

Stehleuchte · Floor lamp

↑ 154 cm, ↔ 28 cm
incl. 3 x SMD-LED, 4,7 W
3 x 470 lm, 3.000 K



473190307
473190331
473190332



07 | Nickel matt · nickel mat



31 | Weiß matt · white mat



32 | Schwarz matt · black mat





EDWARD

Metall, Schwarz matt · metal, black mat ·
 metale, noir mat · metaal, mat zwart ·
 metal, estera negra · metallo, nero opaco ·
 metal, negru mat · metalli, mattamusta ·
 metal, czarny mat

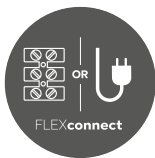

Seite/page 648



Wandleuchte · Wall lamp
 ↓ 25 cm, ↔ 12 cm, ↗ 50 cm
 excl. 1 x E14, max. 28 W



208870132



Stehleuchte · Floor lamp
 ↓ 160 cm, ↔ 38 cm
 excl. 3 x E14, max. 40 W



408800332



ICARO

Metall, Glas matt · metal, mat glass ·
 metale, verre mat · metaal, mat glas · metal, vidrio mate ·
 metallo, vetro sabbiato · metal, sticla mata · metalli, mattalasi · metal, szkło matowane

Stehleuchte · Floor lamp
 ↑ 165 cm, ↗ 54 cm
 excl. 1 x E27, max. 60 W



4035011-04
 4035011-07
 4035011-08

 04 | Altmessing · old brass

 07 | Nickel matt · nickel mat

 08 | Messing matt · brass mat





FILIGRAN

Nickel matt oder Schwarz matt · nickel mat or black mat ·
 nickel mat ou noir mat · nikkell mat of mat zwart · níquel mate o estera negra ·
 nichel opaco o nero opaco · nichel mat sau negru mat · harjattu teräs tai mattamusta · nikiel mat lub czarny mat



Sensordimmer ·
 Sensor dimmer

Stehleuchte · Floor lamp
 † 162 cm, † 52 cm
 incl. 1 x SMD-LED, 6 W
 560 lm, 3.000 K



420490107
 420490132



07 | Nickel matt · nickel mat



32 | Schwarz matt · black mat





Tischleuchte · Table lamp

↑ 45 cm, ↔ 12 cm, ↗ 25 cm
excl. 1 x GU10, max. 5 W



- 512400107
- 512400108
- 512400131
- 512400132



07 | Nickel matt · nickel mat



08 | Messing matt / Schwarz matt
brass matt / black mat



31 | Weiß matt · white mat



32 | Schwarz matt · black mat

480



Stehleuchte · Floor lamp

↑ 151 cm, ↔ 23 cm, ↗ 39 cm
excl. 1 x GU10, max. 5 W



- 412400107
- 412400108
- 412400131
- 412400132



MARLEY

Metall · metal ·
metale · metaal · metal · metallo · metal · metalli · metal

Empfohlen:
recommended: LED GU10, 5 W
400 lm, 3.000 K



956-55





GRANDE

Kunststoff, Weiß · plastic, white ·
 plastique, blanc · kunststof, wit · plástico, blanco ·
 plastica, bianco · plastic, alb · muovi, valkoinen · plastik, biały



Lichtfarbe einstellbar ·
 Adjustable light color



4 fach TOUCH ·
 4 level Touch function



USB Anschluss mit Ladefunktion ·
 Recharging USB connection



Tischleuchte · Table lamp
 ↑ 62 cm, ↔ 17,5 cm, ↗ 50 cm
 incl. 1 x SMD-LED, 9 W
 1.300 lm, 3.000 + 4.000 + 5.000 K



525690101



AVA

Kunststoff · plastic ·
plastique · kunststof · plástico ·
plastica · plastic · muovi · plastik



Lichtfarbe einstellbar ·
Adjustable light color



Sensordimmer ·
Sensor dimmer



USB Anschluss mit Ladefunktion ·
Recharging USB connection



Memory Funktion ·
Memory function



Tischleuchte · Table lamp
↓ 40,4 cm, ↔ 17,1 cm, ↗ 30,5 cm
incl. SMD-LED, 5 W
600 lm, 3.000 + 4.000 + 6.300 K



523090131 | Weiß matt · white mat
523090132 | Schwarz matt · black mat



AMSTERDAM

Metall, Weiß oder Schwarz · metal, white or black ·
 metale, blanc ou noir · metaal, wit of zwart · metal, blanco o negro ·
 metallo, bianco o nero · metal, alb sau negru · metalli, valkoinen tai musta · metal, biały lub czarny

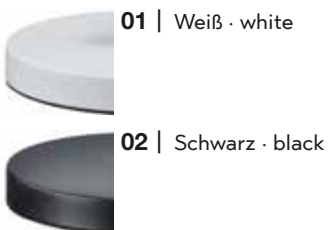

Tischleuchte · Table lamp
 ↓ max. 90 cm, ↗ max. 90 cm, Ø 18 cm
 incl. 1 x COB-LED, 5 W
 500 lm, 3.000 K





527920101
 527920102





NADAL

Metall, Kunststoff, Schwarz matt oder titanfarbig · metal, plastic, black mat or titan ·
 metale, plastique, noir mat ou titane · metaal, kunststof, mat zwart of titaan · metal, plástico, estera negra o titán ·
 metallo, plastica, nero opaco o titano · metal, plastic, negru mat sau titaniu · metalli, muovi, mattamusta tai titaani ·
 metal, plastik, czarny mat lub tytanowy

 Lichtfarbe stufenlos einstellbar ·
 Light color infinitely variable

 Sensordimmer ·
 Sensor dimmer

 **32** | Schwarz matt · black mat

 **87** | titanfarbig · titanium-coloured

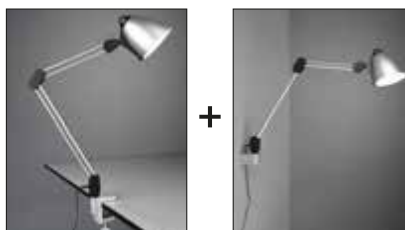

Tischleuchte · Table lamp
 ↑ max. 57 cm, ↔ 19 cm, ↗ max. 46 cm
 incl. SMD-LED, 6,8 W
 640 lm, 3.000 - 5.000 K



525410132
525410187

RODERIC

Metall, Kunststoff · metal, plastic ·
metale, plastique · metaal, kunststof · metal, plástico ·
metallo, plastica · metal, plastic · metalli, muovi · metal, plastik



01 | Weiß · white



42 | Anthrazit · anthracite

Tischleuchte · Table lamp
↑ 50 cm, ↔ 19 cm, √ 55 cm
incl. 1 x SMD-LED, 6 W
670 lm, 3.000 K



527410101
527410142



486

VARIO

Metall, Kunststoff · metal, plastic ·
metale, plastique · metaal, kunststof · metal, plástico ·
metallo, plastica · metal, plastic · metalli, muovi · metal, plastik



02 | Schwarz · black



87 | titanfarbig · titanium-coloured



Tischleuchte · Table lamp
↑ max. 64,5 cm, √ max. 50 cm
incl. SMD-LED, 3,6 W
200 lm, 3.000 K



522520102
522520187





RADO

Metall, Kunststoff · metal, plastic ·
 metale, plastique · metaal, kunststof · metal, plástico ·
 metallo, plastica · metal, plastic · metalli, muovi · metal, plastik



Lichtfarbe einstellbar ·
 Adjustable light color



4 fach TOUCH ·
 4 level Touch function

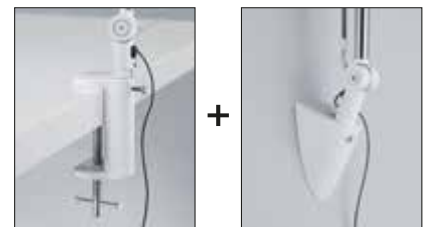

31 | Weiß matt · white mat



32 | Schwarz matt · black mat

Tischleuchte · Table lamp
 ↑ 70 cm, ↗ 38 cm
 incl. 1 x SMD-LED, 5 W
 550 lm, 3.000 + 4.000 + 5.000 K



527690131
 527690132

POLO

Kunststoff · plastic ·
plastique · kunststof · plástico · plastica · plastic · muovi · plastik



Lichtfarbe einstellbar ·
Adjustable light color



4 fach TOUCH ·
4 level Touch function

Tischleuchte · Table lamp

↑ 41 cm, ↗ 40 cm

incl. 1 x SMD-LED, 5 W

550 lm, 3.000 + 4.000 + 5.000 K



527090111 | Grau · grey

527090131 | Weiß matt · white mat



488

POLLY

Kunststoff · plastic ·
plastique · kunststof · plástico · plastica · plastic · muovi · plastik



4 fach TOUCH ·
4 level Touch function

Tischleuchte · Table lamp

↑ 40 cm, ↔ 16 x 16 cm, ↗ 39 cm

incl. 1 x SMD, 4,8 W

450 lm, 3.000 K



573910101 | Weiß · white

573910106 | Chrom · chrome





KIMI

Metall, Holz · metal, wood ·
 metale, bois · metaal, hout · metal, madera ·
 metallo, di legno · metal, lemn · metalli, puu · metal, drewno

31 | Weiß matt · white mat

32 | Schwarz matt · black mat



Tischleuchte · Table lamp

‡ max. 50 cm, Ø 16 cm, ∇ max. 37,5 cm
 excl. 1 x E27, max. 42 W



508300131
 508300132



PRETO

Metall, Kunststoff · metal, plastic ·
 metale, plastique · metaal, kunststof · metal, plástico ·
 metallo, plastica · metal, plastic · metalli, muovi · metal, plastik



Tischleuchte · Table lamp
 ↓ max. 40 cm, ↔ 7,5 cm, ↗ 40 cm
 incl. SMD, 3,8 W
 350 lm, 3.100 K



528380107



Tischleuchte · Table lamp
 ↓ max. 40 cm, ↔ 11,5 cm, ↗ 25 cm
 incl. SMD, 3,8 W
 350 lm, 3.100 K



528310107



LUPO

Kunststoff · plastic ·
 plastique · kunststof · plástico · plastica · plastic · muovi · plastik

 4 fach TOUCH ·
 4 level Touch function

 **01** | Weiß · white

 **02** | Schwarz · black



Tischleuchte · Table lamp
 ↑ 35 cm, Ø 13,5 cm, √ 30 cm
 incl. 1 x SMD-LED, 5 W
 550 lm, 3.500 K



527290101
 527290102

PRONTO

Metall, Kunststoff · metal, plastic ·
metale, plastique · metaal, kunststof · metal, plástico ·
metallo, plastica · metal, plastic · metalli, muovi · metal, plastik



01 | Weiß · white

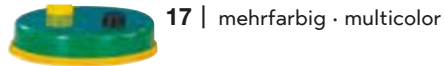

17 | mehrfarbig · multicolor

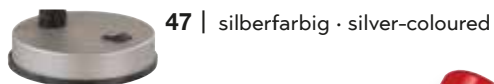

47 | silberfarbig · silver-coloured

Tischleuchte · Table lamp
↑ 30 cm, Ø 13,1 cm, ∠ 22 cm
excl. 1 x E27, max. 18 W



5027011-01
5027011-17
5027011-47



FLEXO

Metall, Kunststoff · metal, plastic ·
metale, plastique · metaal, kunststof · metal, plástico ·
metallo, plastica · metal, plastic · metalli, muovi · metal, plastik



01 | Weiß · white

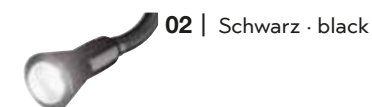

02 | Schwarz · black

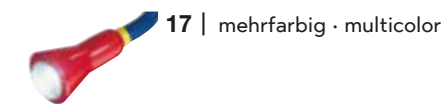

17 | mehrfarbig · multicolor

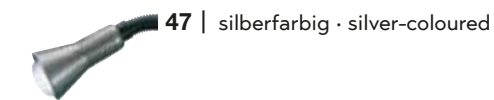

47 | silberfarbig · silver-coloured

Tischleuchte · Table lamp
↑ 30 cm, ∠ 30 cm
excl. 1x E14, max. 18 W



5028010-01
5028010-02
5028010-17
5028010-47





TAJO

Metall · metal ·
 metale · metaal · metal ·
 metallo · metal · metalli · metal



01 | Weiß · white

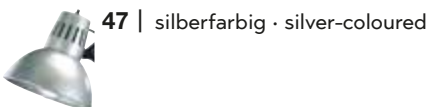

47 | silberfarbig · silver-coloured

Tischleuchte · Table lamp
 ↓ 73,5 cm, Ø 16,8 cm, √ 51 cm
 excl. 1 x E27, max. 40 W



5029010-01
 5029010-47

VENTURA

Metall, Glas matt · metal, mat glass ·
metale, verre mat · metaal, mat glas · metal, vidrio mate ·
metallo, vetro sabbiato · metal, sticla mata · metalli, mattalasi ·
metal, szkło matowane



4 fach TOUCH ·
4 level Touch function



03 | Messing poliert · polished brass



07 | Nickel matt · nickel mat

Tischleuchte · Table lamp

↑ 29 cm, Ø 15,5 cm
incl. 1 x SMD-LED, 4 W
350 lm, 3.000 K



529990103
529990107



LUIS

Metall, Glas alabasterfarbig · metal, alabaster-coloured glass ·
metale, verre couleur albâtre · metaal, albastkleurig glas ·
metal, vidrio de color alabastro · metallo, vetro colore alabastro ·
metal, sticla culoare alabastru · metalli, lasi alabasteri väri ·
metal, szkło alabaster kolor



4 fach TOUCH ·
4 level Touch function



06 | Chrom · chrome



07 | Nickel matt · nickel mat



08 | Messing matt · brass mat

Tischleuchte · Table lamp

↑ 32 cm, Ø 12
excl. 1 x E14, max. 40 W



595500106
595500107
595500108





CURTIS

Altmessing, Nickel matt oder Messing matt · old brass, nickel mat or brass mat ·
 laiton fumé, nickel mat ou laiton mat · oud brons, nikkel mat of messing mat · bronce viejo, níquel mate o bronce mate · ottone invecchiato, nichel opaco o
 ottone satinato · bronz antic, nichel mat sau bronz mat · antiikkimessinki, harjattu teräs tai mattamessinki · patyna, nikiel mat lubmosiádz mat



4 fach TOUCH ·
 4 level Touch function



04 | Altmessing · old brass



07 | Nickel matt · nickel mat



08 | Messing matt · brass mat



Tischleuchte · Table lamp
 ↑ 35 cm, ↔ 18 cm, ↗ max. 15 cm
 incl. SMD-LED, 4 W
 380 lm, 3.000 K



579790104
 579790107
 579790108

DONNA

Metall, Glas alabasterfarbig · metal, alabaster-coloured glass ·
metale, verre couleur albâtre · metaal, albastkleurig glas ·
metal, vidrio de color alabastro · metallo, vetro colore alabastro ·
metal, sticla culoare alabastru · metalli, lasi alabasteri väri ·
metal, szkło alabaster kolor



4 fach TOUCH ·
4 level Touch function



07 | Nickel matt · nickel mat



08 | Messing matt · brass mat



32 | Schwarz matt · black mat

Tischleuchte · Table lamp

↑ 30 cm, Ø 22,5 cm
incl. 1 x SMD-LED, 4 W
350 lm, 3.000 K



525790107
525790108
525790132



EMERALD

Metall, Glas matt · metal, mat glass ·
metale, verre mat · metaal, mat glas · metal, vidrio mate ·
metallo, vetro sabbaiato · metal, sticla mata · metalli, mattalasi ·
metal, szkło matowane



4 fach TOUCH ·
4 level Touch function



06 | Chrom · chrome



07 | Nickel matt · nickel mat

Tischleuchte · Table lamp

↑ 29 cm, Ø 15 cm
incl. 1 x SMD-LED, 4 W
350 lm, 3.000 K



525490106
525490107





32

BERLIN

Metall, Glas matt · metal, mat glass ·
 metale, verre mat · metaal, mat glas ·
 metal, vidrio mate · metallo, vetro sabbiato ·
 metal, sticla mata · metalli, mattalasi ·
 metal, szkło matowane · metal, mat cam



4 fach TOUCH ·
 4 level Touch function



07



79

Tischleuchte · Table lamp

↓ 39 cm, Ø 19,5 cm
 incl. 1 x SMD-LED, 4 W
 350 lm, 3.000 K



527590107 | Nickel matt · nickel mat
 527590132 | Schwarz matt · black mat
 527590179 | goldfarbig · gold

JOOST

Nickel matt, Glas matt · nickel mat, mat glass ·
nickel mat, verre mat · nikkel mat, mat glas ·
níquel mate, vidrio mate · nichel opaco, vetro sabbato ·
nichel mat, sticla mata · harjattu teräs, mattalasi ·
nikiel mat, szkło matowane



4 fach TOUCH ·
4 level Touch function

Tischleuchte · Table lamp

↑ 39 cm, Ø 19 cm
excl. 1 x E27, max. 60 W



5922011-07



498

HENK

Metall, Glas alabasterfarbig · metal, alabaster-coloured glass ·
metale, verre couleur albâtre · metaal, albastkleurig glas ·
metal, vidrio de color alabastro · metallo, vetro colore alabastro ·
metal, sticla culoare alabastru · metalli, lasi alabasteri väri ·
metal, szkło alabaster kolor



4 fach TOUCH ·
4 level Touch function



07 | Nickel matt · nickel mat



08 | Messing matt · brass mat

Tischleuchte · Table lamp

↑ 37 cm, Ø 26 cm
excl. 1 x E14, max. 40 W



5925011-07

5925011-08





FYNN

Metall, Glas alabasterfarbig · metal, alabaster-coloured glass ·
 metale, verre couleur albâtre · metaal, albastkleurig glas · metal, vidrio de color alabastro ·
 metallo, vetro colore alabastro · metal, sticla culoare alabastru · metalli, lasi alabasteri väri ·
 metal, szkło alabaster kolor

 4 fach TOUCH ·
 4 level Touch function

Empfohlen:
 recommended: LED E14, 5 W
 400 lm, 3.000 K



983-56

Tischleuchte · Table lamp
 ↑ 21 cm, Ø 15 cm
 excl. 1 x E14, max. 40 W



- 599000106 | Chrom · chrome
- 599000107 | Nickel matt · nickel mat
- 599000108 | Messing matt · brass mat
- 599000118 | Orange · orange
- 599000124 | rostfarbig · rusty

CRISTO

Chrom oder Nickel matt, Glas · chrome or nickel mat, glass ·
chrome ou nickel mat, verre · chrom of nikkell mat, glas ·
cromo o níquel mate, vidrio · cromo o nichel opaco, vetro ·
crom sau nichel mat, sticla · kromi tai harjattu teräs, lasi ·
chrom lub nikiel mat, szkło



4 fach TOUCH ·
4 level Touch function



00 | Transparent · transparent



07 | Nickel matt · nickel mat

Tischleuchte · Table lamp

↑ 14,5 cm, Ø 11 cm

incl. 1 x SMD-LED, 4,3 W

430 lm, 3.000 K



529690100

529690107



ARY

Metall, Glas matt · metal, mat glass ·
metale, verre mat · metaal, mat glas · metal, vidrio mate ·
metallo, vetro sabbaiato · metal, sticla mata · metalli, mattalasi ·
metal, szkło matowane



4 fach TOUCH ·
4 level Touch function



07 | Nickel matt · nickel mat



32 | Schwarz matt · black mat

Tischleuchte · Table lamp

↑ 15 cm, Ø 9 cm

excl. 1 x E14, max. 40 W



5908011-07

5908011-32



TILL

Metall, Glas matt · metal, mat glass ·
metale, verre mat · metaal, mat glas · metal, vidrio mate ·
metallo, vetro sabbiato · metal, sticla mata · metalli, mattalasi ·
metal, szkło matowane

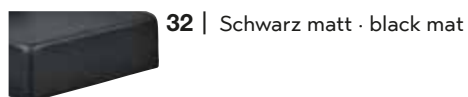

Tischleuchte · Table lamp

↑ 14,5 cm, ↔ 10 x 15 cm
excl. 1 x E14, max. 40 W



5901011-07

5901011-32



501

DAVI

Metall, Glas matt · metal, mat glass ·
metale, verre mat · metaal, mat glas · metal, vidrio mate ·
metallo, vetro sabbiato · metal, sticla mata · metalli, mattalasi ·
metal, szkło matowane

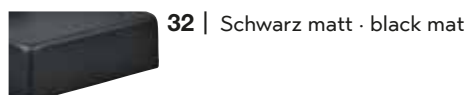

Tischleuchte · Table lamp

↑ 15 cm, ↔ 10 x 15 cm
excl. 1 x E14, max. 40 W



5900011-07

5900011-32



SETA

Nickel matt, Glas · nickel mat, glass ·
nickel mat, verre · nikkell mat, glas · níquel mate, vidrio ·
nichel opaco, vetro · nichel mat, sticla · harjattu teräs, lasi ·
nikiel mat, szkło



On/Off Touch Funktion ·
On/Off Touch function

Tischleuchte · Table lamp

↑ 21 cm, Ø 8,5 cm
incl. 1 x LED E14, 4 W
320 lm, 3.000 K



574090107



MORTEN

Nickel matt, Glas alabasterfarbig · nickel mat, alabaster-coloured
glass · nickel mat, verre couleur albâtre · nikkell mat, albastkleurig
glas · níquel mate, vidrio de color alabastro · nichel opaco, vetro
colore alabastro · nichel mat, sticla culoare alabastru · harjattu
teräs, lasi alabasteri väri · nikiel mat, szkło alabaster kolor



4 fach TOUCH ·
4 level Touch function

Tischleuchte · Table lamp

↔ 15 x 8 cm, ↑ 18 cm
excl. 1 x G9, max. 28 W



592000107



MONTI

Nickel matt, Glas · nickel mat, glass ·
nickel mat, verre · nikkell mat, glas · níquel mate, vidrio ·
nichel opaco, vetro · nichel mat, sticla · harjattu teräs, lasi ·
nikiel mat, szkło

Tischleuchte · Table lamp

↑ 25,5 cm, Ø 15 cm
incl. 1 x LED E14, 4 W
320 lm, 3.000 K



529310107



503

LACAN

Chrom, Acryl · chrome, acryl ·
chrome, acryl · chroom, acryl · cromo, acrílico ·
cromo, acrilico · crom, acrilic · kromi, akryyli · chrom, akryl



4 fach TOUCH ·
4 level Touch function

Tischleuchte · Table lamp

↑ 30 cm, Ø 13 cm
excl. 1 x E14, max. 40 W



593900100





MATS

Nickel matt, Stoff · nickel mat, fabric ·
nickel mat, tissu · nikkel mat, textiel · níquel mate, tela ·
nichel opaco, tessuto · nichel mat, textil · harjattu teräs, tekstiili · nikiel mat, tkanina



4 fach TOUCH ·
4 level Touch function



01 | Weiß · white



02 | Schwarz · black



15 | Grün · green

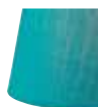

19 | Türkis · turquoise



42 | Anthrazit · anthacite

Tischleuchte · Table lamp

↓ 24 cm, Ø 14 cm
excl. 1 x E14, max. 40 W



599600101
599600102
599600115
599600119
599600142



PIET

Nickel matt, Stoff · nickel mat, fabric ·
 nickel mat, tissu · nikkel mat, textiel · níquel mate, tela ·
 nichel opaco, tessuto · nichel mat, textil · harjattu teräs, tekstiili · nikiel mat, tkanina



4 fach TOUCH ·
 4 level Touch function



01 | Weiß · white



02 | Schwarz · black



42 | Anthrazit · anthracite

Tischleuchte · Table lamp
 ↓ 35 cm, ↔ 12 x 12 cm
 excl. 1 x E14, max. 40 W



5914011-01
 5914011-02
 5914011-42





506 - 545

Spotserien

- Spots
- Spotterie
- Spots
- Focos
- Faretti
- Spoturi
- Spotit
- Reflektorki



geeignet für Auf- und Einbau · suitable for both mounting and installation · adapté au montage et à l'installation · geschikt voor in en opbouw · apropiadas tanto para montaje como para instalación · ideale sia per montaggio e installazione · adecvate pentru aplicare și încorporare · sopii pinta- ja uppoasennukseen · odpowiednie zarówno do montażu jak i instalacji

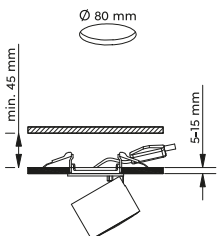

Strahler · Spot
 Ø 8,7 cm, ↑ 10,6 cm
 incl. SMD-LED, 3,5 W
 340 lm, 3.000 K
 incl. SMD-LED, 1,5 W
 110 lm, 3.000 K



652910131
 652910132

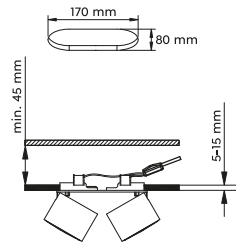

Strahler · Spot
 ↔ 18 x 8,7 cm, ↑ 10,6 cm
 incl. 2 x SMD-LED, 3,5 W
 2 x 340 lm, 3.000 K
 incl. 2 x SMD-LED, 1,5 W
 2 x 110 lm, 3.000 K



652910231
 652910232

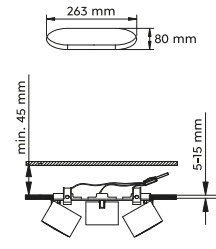

Strahler · Spot
 ↔ 27,3 x 8,7 cm, ↑ 10,6 cm
 incl. 3 x SMD-LED, 3,5 W
 3 x 340 lm, 3.000 K
 incl. 3 x SMD-LED, 1,5 W
 3 x 110 lm, 3.000 K



652910331
 652910332



31 | Weiß matt · white mat



32 | Schwarz matt · black mat



TAURUS

Metall, Weiß matt oder Schwarz matt · metal, white mat or black mat ·
 metale, blanc mat ou noir mat · metaal, wit mat of mat zwart · metal, estera blanca o estera negra ·
 metallo, bianco opaco o nero opaco · metal, alb mat sau negru mat · metalli, valkoinen matto tai musta matto · metal, biały mat lub czarny mat

 Getrennt schaltbar ·
 Separately switchable



1x



2x



3x





Strahler · Spot
 ↔ 10 x 15 cm, ↗ 15 cm
 incl. 1 x SMD-LED, 4,3 W
 430 lm, 3.000 K
 incl. 1 x SMD, 3 W
 280 lm, 3.000 K



828570231



Strahler · Spot
 ↔ 30 x 8,5 cm, ↓ 14 cm
 incl. 2 x SMD-LED, 4,3 W
 2 x 430 lm, 3.000 K
 incl. 1 x SMD, 4 W
 330 lm, 3.000 K



828510331



Strahler · Spot
 ↔ 42 x 8,5 cm, ↓ 15,5 cm
 incl. 3 x SMD-LED, 4,3 W
 3 x 430 lm, 3.000 K
 incl. 1 x SMD, 8 W
 640 lm, 3.000 K



828510431



Strahler · Spot
 ↔ 28 x 28 cm, ↓ 14 cm
 incl. 4 x SMD-LED, 4,3 W
 4 x 430 lm, 3.000 K
 incl. 1 x SMD, 8 W
 640 lm, 3.000 K



828530531



CUBA

Metall, Weiß matt · metal, white mat ·
 metale, blanc mat · metaal, wit mat · metal, estera blanca ·
 metallo, bianco opaco · metal, alb mat · metalli, mattavalkoinen · metal, biały mat



Getrennt schaltbar ·
 Separately switchable



1x

2x

3x

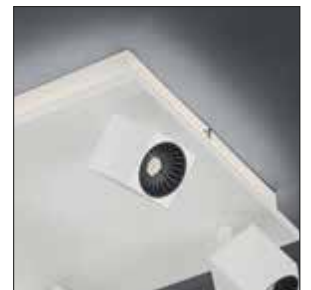
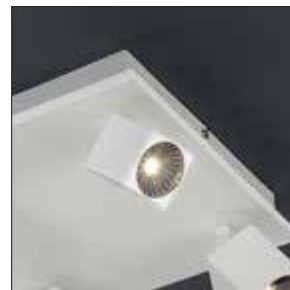



Strahler · Spot
 ↔ 36 x 7 cm, ↑ 18,5 cm
 incl. 2 x SMD-LED, 4,3 W
 2 x 430 lm, 3.000 K



821470205



Strahler · Spot
 ↔ 50 x 7 cm, ↑ 18,5 cm
 incl. 3 x SMD-LED, 4,3 W
 3 x 430 lm, 3.000 K



821410305



Strahler · Spot
 ↔ 96,5 x 8 cm, ↑ 18,5 cm
 incl. 4 x SMD-LED, 4,3 W
 4 x 430 lm, 3.000 K



821410405



Strahler · Spot
 ↔ max.150 x 8 cm, ↑ 24 cm
 incl. 6 x SMD-LED, 4,3 W
 6 x 430 lm, 3.000 K



821410605

CLAPTON

Aluminium gebürstet, Chrom, Glas Weiß gewischt · brushed aluminium, chrome, glass white brushed glass · aluminium balayé, chrome, verre blanc balayé · geborsteld aluminium, chroom, wit geborsteld glas · aluminio pulido, cromo, blanco pulido · alluminio spazzolato, cromo, vetro bianco spazzolato · aluminiu lucios, crom, alb lucios · harjattu alumiini, kromi, lasi harjattu valkoinen · aluminium szczotkowane, chrom, szkło białe otarła



Strahler · Spot
 ↓ 20 x 7 cm, ↗ 16 cm
 incl. 1 x SMD-LED, 4,3 W
 430 lm, 3.000 K



821470105



Strahler · Spot
 ↔ 31 x 22 cm, ↓ 18,5 cm
 incl. 4 x SMD-LED, 4,3 W
 4 x 430 lm, 3.000 K



821430405



Strahler · Spot
 ↔ 70 x 50 cm, ↓ 23 cm
 incl. 5 x SMD-LED, 4,3 W
 5 x 430 lm, 3.000 K



621410505



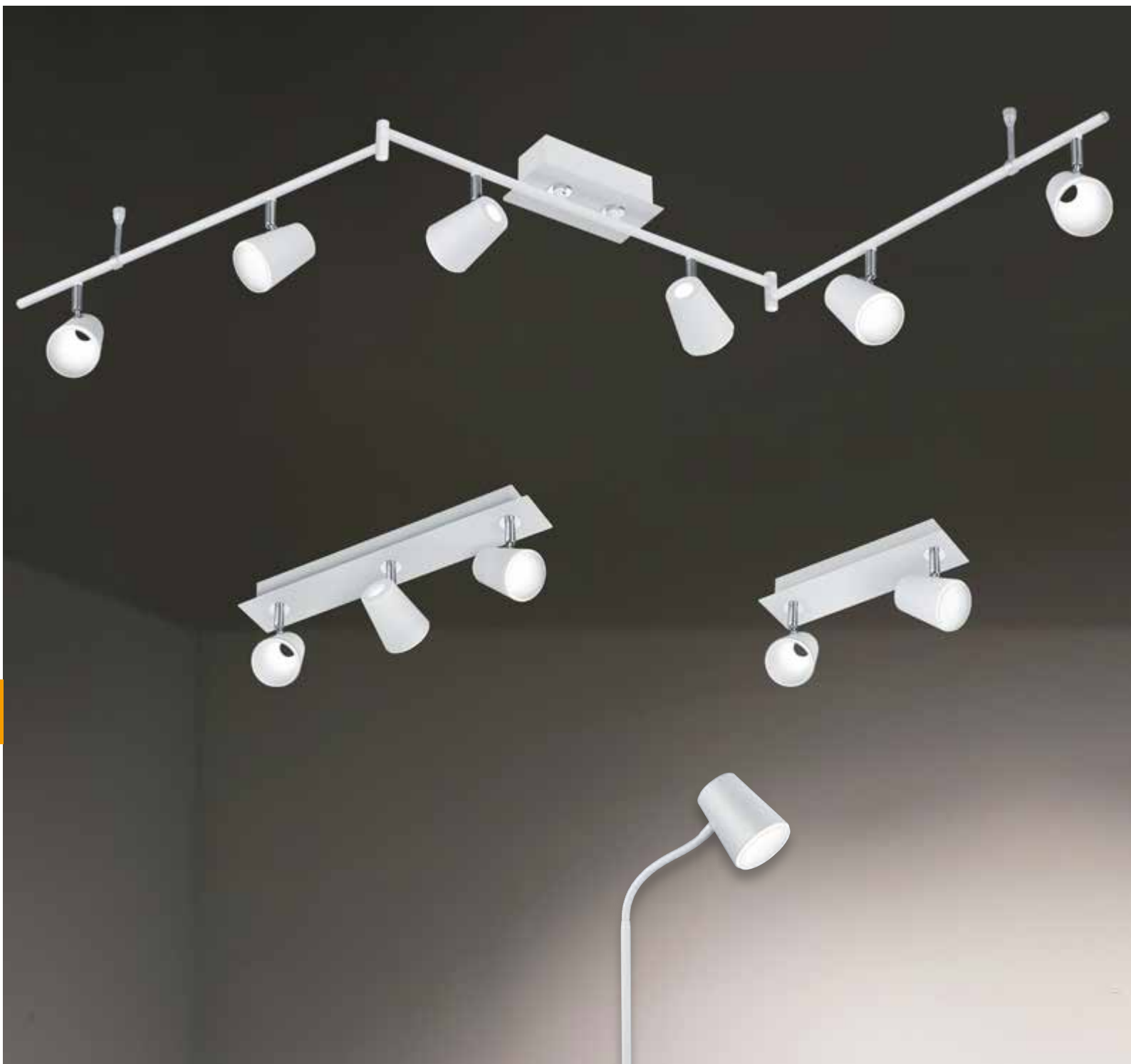

Strahler · Spot
 ↓ 12 x 7,5 cm, ↗ 16 cm
 incl. SMD-LED, 6 W
 550 lm, 3.000 K



873170107
 873170131



Strahler · Spotp
 ↔ 28,5 x 9,5 cm, ↗ 16 cm
 incl. 2 x SMD-LED, 6 W
 2 x 550 lm, 3.000 K



873170207
 873170231



Strahler · Spot
 ↔ 45 x 9,5 cm, ↓ 16 cm
 incl. 3 x SMD-LED, 6 W
 3 x 550 lm, 3.000 K



873110307
 873110331



Strahler · Spot
 ↔ 81,5 x 8 cm, ↓ 20 cm
 incl. 4 x SMD-LED, 6 W
 4 x 550 lm, 3.000 K



873110407
 873110431



NARCOS

Nickel matt oder weiß · nickel mat or white ·
 nickel mat ou blanc · nikkel mat of wit · níquel mate o blanco · nichel opaco o bianco ·
 nichel mat sau alb · harjattu teräs tai valkoinen · nikiel mat lub biały



07 | Nickel matt · nickel mat



31 | Weiß matt · white mat

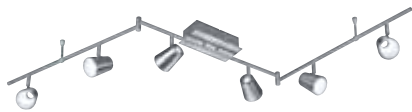

Strahler · Spot

↔ 177 x 10 cm, ↓ 23 cm
 incl. 6 x SMD-LED, 6 W
 6 x 550 lm, 3.000 K



873110607
 873110631



Tischleuchte · Table lamp

↓ 38 cm, ↗ 23 cm
 incl. SMD-LED, 4,7 W
 470 lm, 3.000 K



573190107
 573190131



Stehleuchte · Floor lamp

↓ 154 cm, ↔ 28 cm
 incl. 3 x SMD-LED, 4,7 W
 3 x 470 lm, 3.000 K



473190307
 473190331





Strahler · Spot
 ↓ 13 x 13 cm, ↗ 16 cm
 incl. 1 x SMD, 8 W
 730 lm, 3.000 K



827890131
 827890132



Strahler · Spot
 ↔ 45 x 9 cm, ↗ 16 cm
 incl. 3 x SMD, 6 W
 3 x 550 lm, 3.000 K



827890331
 827890332



Stehleuchte · Floor lamp
 ↓ 154 cm, ↔ 28 cm
 incl. 3 x SMD, 4,7 W
 3 x 470 lm, 3.000 K



427890331
 427890332





LAGOS

Metall, Acryl · metal, acryl ·
metale, acryl · metaal, acryl · metal, acrílico ·
metallo, acrilico · metal, acrilic · metalli, akryyli · metal, akryl



31 | Weiß matt · white mat

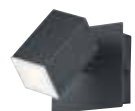

32 | Schwarz matt · black mat



Strahler · Spot
↔ 30 x 9 cm, ↗ 16 cm
incl. 2 x SMD, 6 W
2 x 550 lm, 3.000 K



827890231
827890232



Strahler · Spot
↔ 25 x 25 cm, ↑ 16 cm
incl. 4 x SMD, 6 W
4 x 550 lm, 3.000 K



827830431
827830432

PILATUS

Chrom, Acryl · chrome, acryl ·
chrome, acryl · chroom, acryl · cromo, acrílico · cromo, acrílico ·
crom, acrílic · kromi, akryyli · chrom, akryl · krom, akrilik



Seilsystem · Rope system
↔ max. 500 x 13,5 cm, ↑ 15 cm
incl. 5 x SMD-LED, 3,8 W
5 x 350 lm, 3.000 K

775910506



SHARK

Nickel matt, Acryl · nickel mat, acryl ·
nickel mat, acryl · nikkell mat, acryl · níquel mate, acrílico ·
nichel opaco, acrílico · nichel mat, acrílic · harjattu teräs, akryyli ·
nikiel mat, akryl · mat nikel, akrilik



Seilsystem · Rope system
↔ max. 700 x 13,5 cm, ↑ 14,5 cm
incl. 7 x SMD-LED, 2,5 W
7 x 245 lm, 3.000 K

779310707

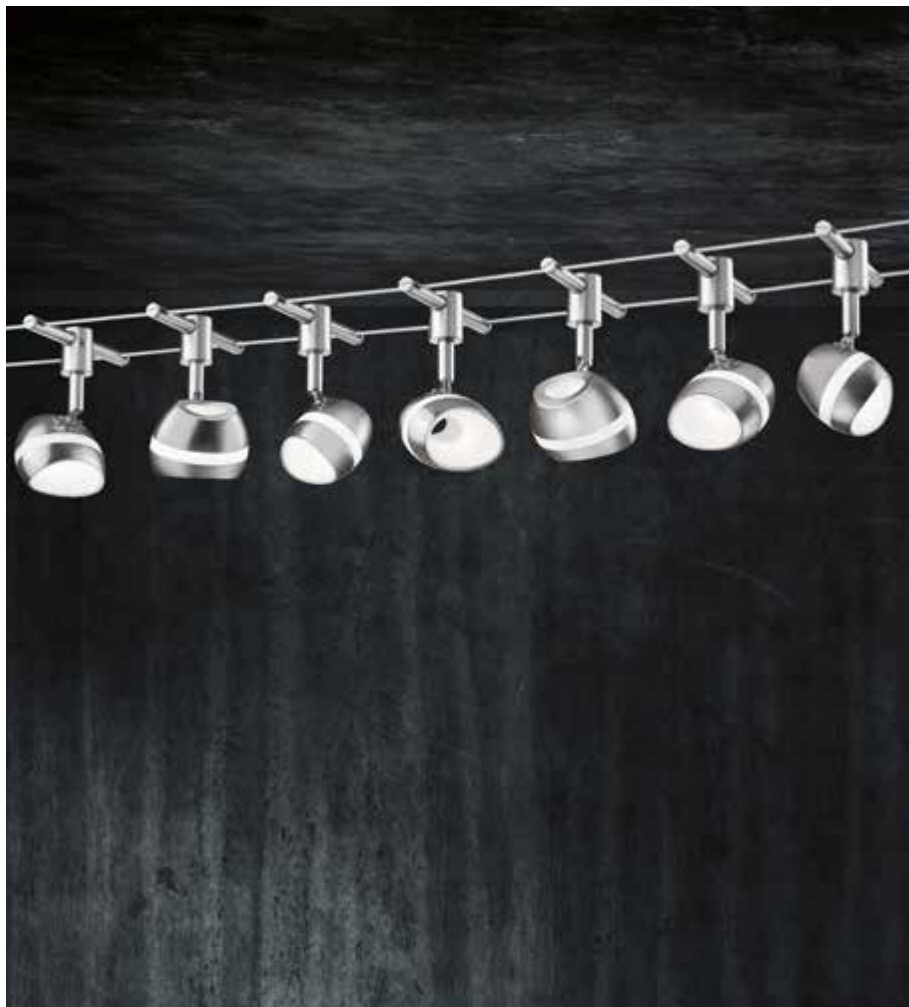



BASIC

titanfarbig · titan ·
titane · titaan · titán · titano ·
titaniu · titaani · tytanowy



Seilsystem · Rope system

↔ max. 500 x 8 cm, ↓ 28 cm
incl. 5 x LED GU5,3/MR16, 3 W
5 x 260 lm, 3.000 K

770010587



BALOUBET

Chrom, Acryl · chrome, acryl ·
chrome, acryl · chroom, acryl · cromo, acrílico ·
cromo, acrílico · crom, acrílic · kromi, akryyli ·
chrom, akryl



Seilsystem · Rope system

↔ max. 500 x 11 cm, ↓ 15,7 cm
incl. 5 x SMD-LED, 3,8 W
5 x 350 lm, 3.100 K

778210506

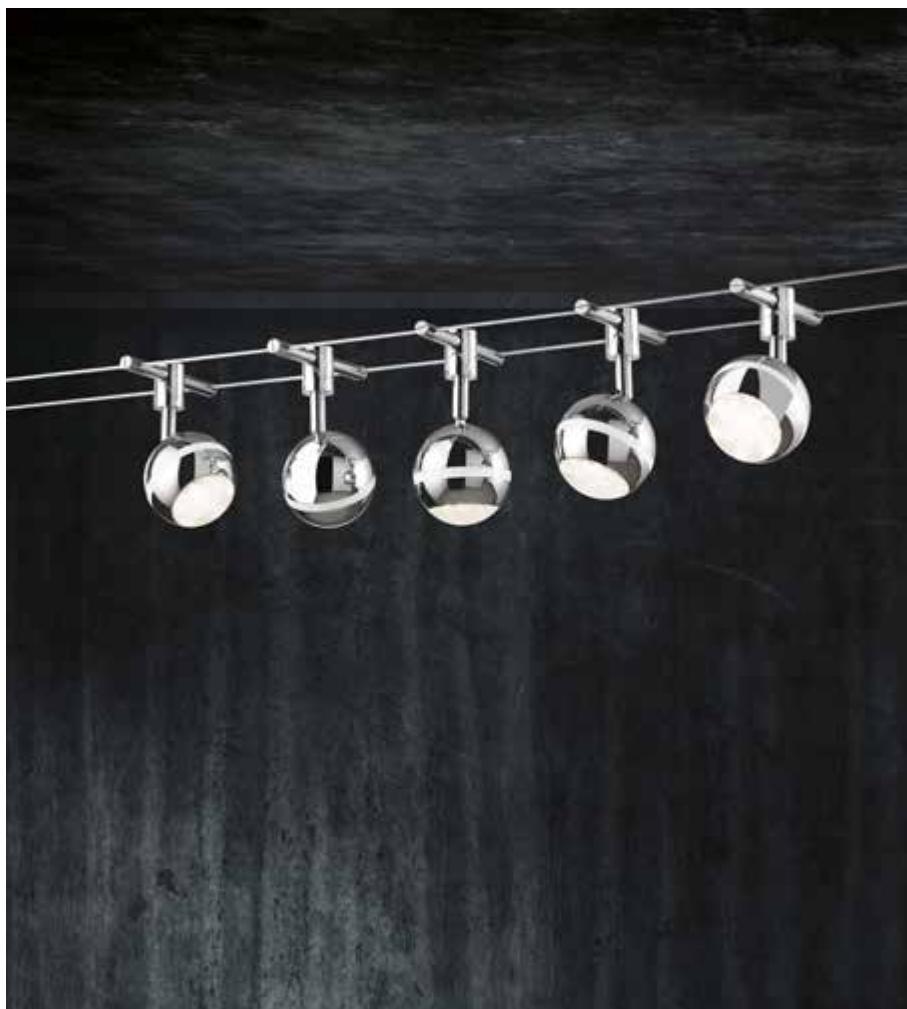





Strahler · Spot
 ↔ 11 x 16 cm, ∅ 19 cm
 excl. 1 x GU10, max. 35 W



800700107
800700131
800700132



Strahler · Spot
 ↔ 28 x 16 cm, ∅ 19 cm
 excl. 2 x GU10, max. 35 W



800700207
800700231
800700232



Strahler · Spot
 ↔ 44 x 16 cm, ∅ 19 cm
 excl. 3 x GU10, max. 35 W



800700307
800700331
800700332



Strahler · Spot
 ↔ 60 x 16 cm, ∅ 19 cm
 excl. 4 x GU10, max. 35 W



800700407
800700431
800700432



LEON

Nickel matt, Weiß matt oder Schwarz matt · nickel mat, white mat or black mat ·
 nickel mat, blanc mat ou noir mat · nikkel mat, wit mat of mat zwart ·
 níquel mate, estera blanca o estera negra · nichel opaco, bianco opaco o nero opaco ·
 nichel mat, alb mat sau negru mat · harjattu teräs, valkoinen matto tai musta matto ·
 nikiel mat, biały mat lub czarny mat

Empfohlen:
 recommended: LED GU10, 5 W
 400 lm, 3.000 K



956-55



07 | Nickel matt · nickel mat



31 | Weiß matt · white mat



32 | Schwarz matt · black mat



Strahler · Spot
 ↔ 12 cm, ↓ 12 cm, ↗ 15 cm
 excl. 1 x GU10, max. 25 W



802400104
 802400107



Strahler · Spot
 ↔ 30 x 9 cm, ↓ 15 cm
 excl. 2 x GU10, max. 35 W



802400204
 802400207



Strahler · Spot
 ↔ 48 x 9 cm, ↓ 15 cm
 excl. 3 x GU10, max. 35 W



802400304
 802400307



Strahler · Spot
 ↔ 24 x 24 cm, ↓ 15 cm
 excl. 4 x GU10, max. 35 W



802430404
 802430407



MARLEY

Metall · metal ·
metale · metaal · metal · metallo · metal · metalli · metal

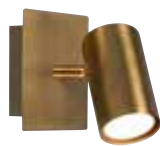

04 | Altmessing · old brass



07 | Nickel matt · nickel mat



Wandleuchte · Wall lamp
↓ 18 cm, ↔ 6 cm, ↗ 8 cm
excl. 2 x GU10, max. 35 W



212400204
212400207



Strahler · Spot
↔ 77,4 x 57,4 cm, ↓ 22,4 cm
excl. 5 x GU10, max. 35 W



612400504
612400507

Empfohlen:
recommended: LED GU10, 5 W
400 lm, 3.000 K



956-55



Strahler · Spot
 ↓ 12 x 12 cm, ↗ 15 cm
 excl. 1 x GU10, max. 25 W



802400101
 802400124
 802400132



Strahler · Spot
 ↔ 30 x 9 cm, ↓ 15 cm
 excl. 2 x GU10, max. 35 W



802400201
 802400224
 802400232



Strahler · Spot
 ↔ 48 x 9 cm, ↓ 15 cm
 excl. 3 x GU10, max. 35 W



802400301
 802400324
 802400332



Strahler · Spot
 ↔ 77,4 x 57,4 cm, ↓ 22,4 cm
 excl. 5 x GU10, max. 35 W



612400501
 612400524
 612400532

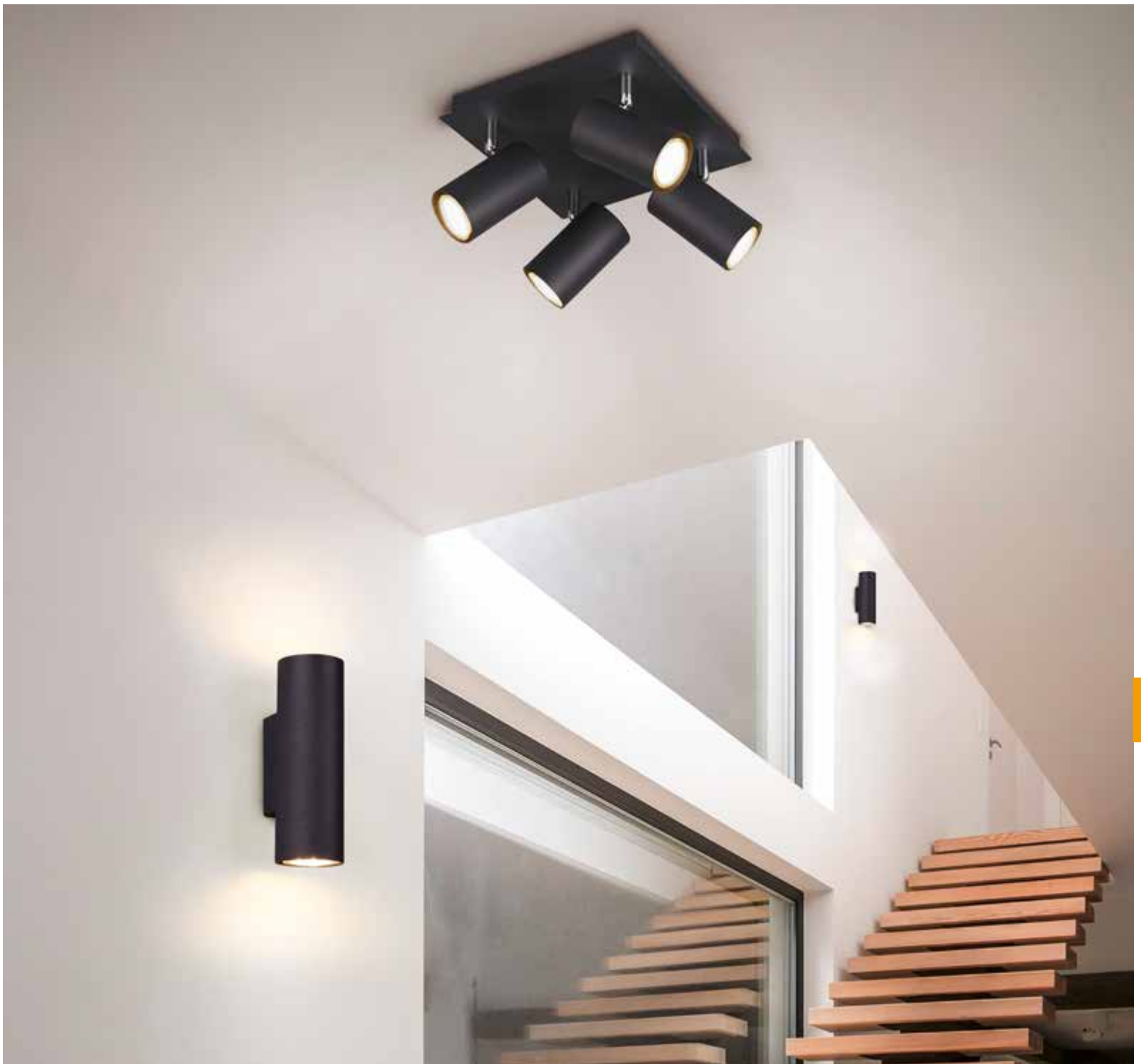

MARLEY

Metall · metal ·
metale · metaal · metal · metallo · metal · metalli · metal



01 | Weiß · white



24 | rostfarbig · rusty



32 | Schwarz matt · black mat



Wandleuchte · Wall lamp
↑ 18 x 6 cm, ∅ 8 cm
excl. 2 x GU10, max. 35 W



212400201
212400224
212400232



Strahler · Spot
↔ 24 x 24 cm, ↓ 15 cm
excl. 4 x GU10, max. 35 W



802430401
802430424
802430432

Empfohlen:
recommended: LED GU10, 5 W
400 lm, 3.000 K



956-55



Strahler · Spot
Ø 25 cm, ↓ 14,5 cm
excl. 3 x GU10, max. 10 W



800690331
800690332



Strahler · Spot
↔ 62 x 11 cm, ↓ 14,5 cm
excl. 4 x GU10, max. 10 W



800600431
800600432



Strahler · Spot
↔ 29 x 11 cm, ↓ 14,5 cm
excl. 2 x GU10, max. 10 W



800600231
800600232



GOA

Metall, Weiß matt oder Schwarz matt · metal, white mat or black mat ·
 metale, blanc mat ou noir mat · metaal, wit mat of mat zwart ·
 metal, estera blanca o estera negra · metallo, bianco opaco o nero opaco ·
 metal, alb mat sau negru mat · metalli, valkoinen matto tai musta matto ·
 metal, biały mat lub czarny mat · metal, beyaz mat veya siyah mat

Empfohlen:
 recommended: LED GU10, 5 W
 400 lm, 3.000 K



956-55



31 | Weiß matt · white mat



32 | Schwarz matt · black mat

Strahler · Spot
 Ø 11 cm, 14,5
 excl. 1 x GU10, max. 10 W



800600131
 800600132



Strahler · Spot
 Ø 10 cm, 15 cm
 excl. 1 x GU10, max. 35 W



803500131
803500132



Strahler · Spot
 ↔ 24 x 7 cm, ↓ 15 cm
 excl. 2 x GU10, max. 35 W



803500231
803500232



Strahler · Spot
 ↔ 41 x 7 cm, ↓ 15 cm
 excl. 3 x GU10, max. 35 W



803500331
803500332



Strahler · Spot
 ↔ 24 x 24 cm, ↓ 15 cm
 excl. 4 x GU10, max. 35 W



803590431
803590432



PAGO

Metall, Weiß matt oder Schwarz matt · metal, white mat or black mat ·
metale, blanc mat ou noir mat · metaal, wit mat of mat zwart ·
metal, estera blanca o estera negra · metallo, bianco opaco o nero opaco ·
metal, alb mat sau negru mat · metalli, valkoinen matto tai musta matto ·
metal, biały mat lub czarny mat

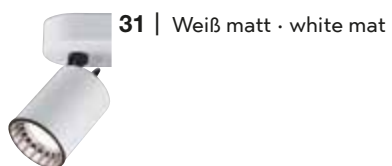

31 | Weiß matt · white mat

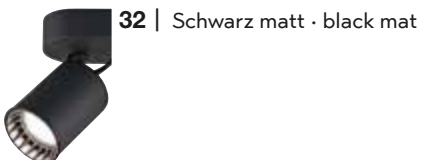

32 | Schwarz matt · black mat

Empfohlen:
recommended: LED GU10, 5 W
400 lm, 3.000 K



956-55





Strahler · Spot
 ↔ 10 x 15 cm, ↗ 18 cm
 excl. 1 x GU10, max. 42 W



802500178



Strahler · Spot
 ↔ 23 x 10 cm, ↓ 18 cm
 excl. 2 x GU10, max. 42 W



802500278



Strahler · Spot
 ↔ 35 x 10 cm, ↓ 18 cm
 excl. 3 x GU10, max. 42 W



802500378



Strahler · Spot
 ↔ 23 x 23 cm, ↓ 18 cm
 excl. 4 x GU10, max. 42 W



802530478



CONCRETE

Beton, Grau · concrete, grey ·
 béton, gris · beton, grijs · hormigón, gris · cemento, grigio ·
 beton, gri · betoni, harmaa · beton, popielaty · beton, gri

Empfohlen:
 recommended: LED GU10, 5 W
 400 lm, 3.000 K



956-55



Stehleuchte · Floor lamp
 ↓ 160 cm, ↔ 34 cm
 excl. 3 x GU10, max. 42 W



402500378

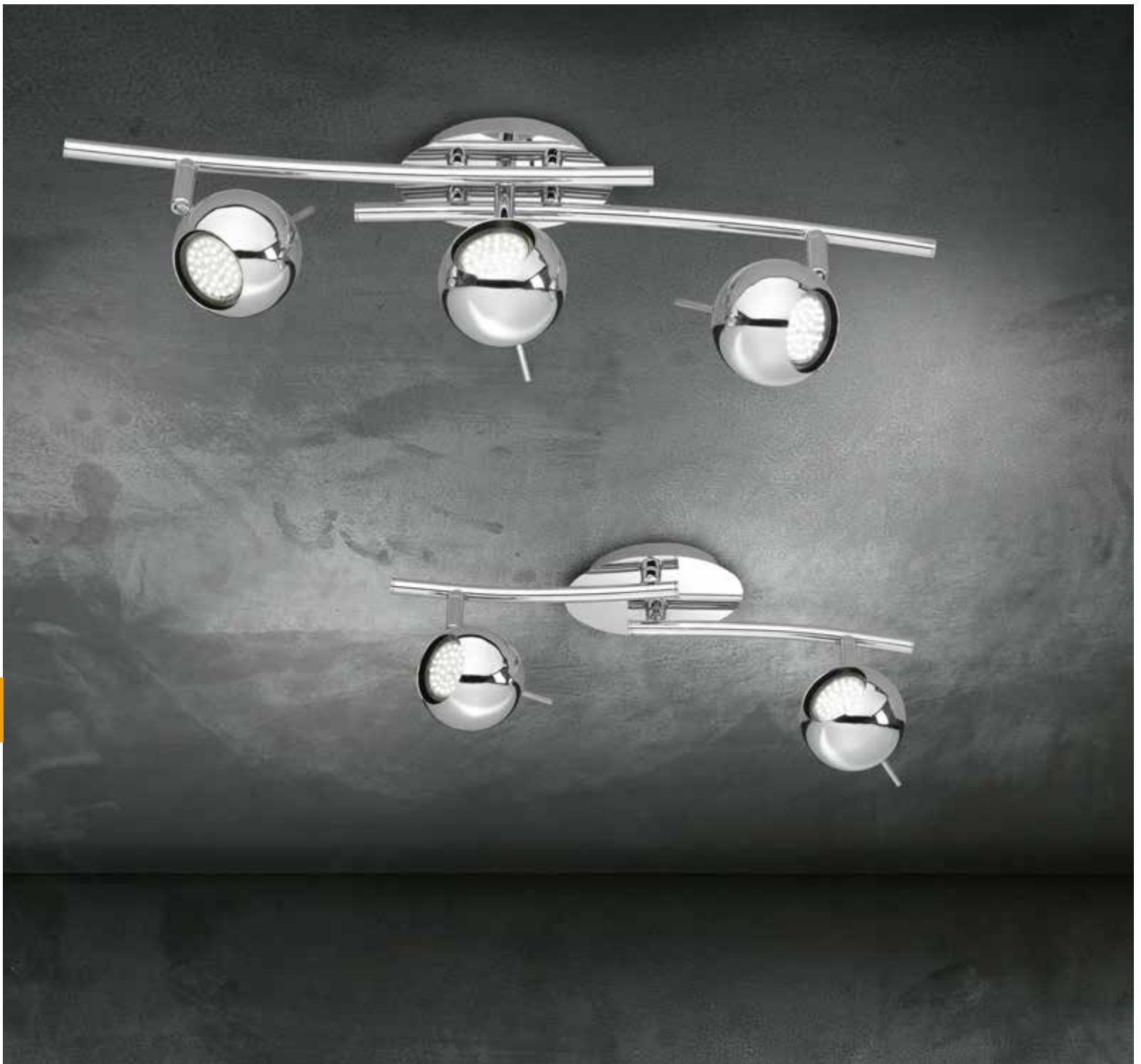

BOWIE

Chrom · chrome ·
chrome · chroom · cromo ·
cromo · crom · kromi · chrom · krom



Strahler · Spot
↓ 14 x 8 cm, ↗ 15 cm
excl. 1 x GU10, max. 25 W



818070106



Strahler · Spot
↔ 40 x 8 cm, ↓ 18 cm
excl. 2 x GU10, max. 25 W



818000206



Strahler · Spot
↔ 55 x 8 cm, ↓ 18 cm
excl. 3 x GU10, max. 25 W



818000306

Empfohlen:
recommended: LED GU10, 3 W
250 lm, 3.000 K



956-30





Strahler · Spot
 ↓ 10,6 x 6 cm, ↗ 13 cm
 excl. 1 x GU10, max. 28 W



803000107



Strahler · Spot
 ↓ 37 x 7 cm, ↗ 22 cm
 excl. 1 x GU10, max. 28 W



803080107



Strahler · Spot
 ↔ 32 x 5 cm, ↓ 13 cm
 excl. 2 x GU10, max. 28 W



803000207



Strahler · Spot
 ↔ 54 x 5 cm, ↓ 13 cm
 excl. 3 x GU10, max. 28 W



803000307



MICHAEL

Nickel matt · nickel mat ·
 nickel mat · nikkell mat · níquel mate ·
 nichel opaco · nichel mat · harjattu teräs ·
 nikiel mat · mat nikel

Empfohlen:
 recommended: LED GU10, 5 W
 400 lm, 3.000 K



956-55



Strahler · Spot
 ↔ 80 x 10 cm, ↓ 20 cm
 excl. 4 x GU10, max. 28 W



803000407



Strahler · Spot
 ↔ 180 x 10 cm, ↓ 18 cm
 excl. 6 x GU10, max. 28 W



803000607



Strahler · Spot
 Ø 25,5 cm, ↓ 15 cm
 excl. 3 x GU10, max. 28 W



803090307

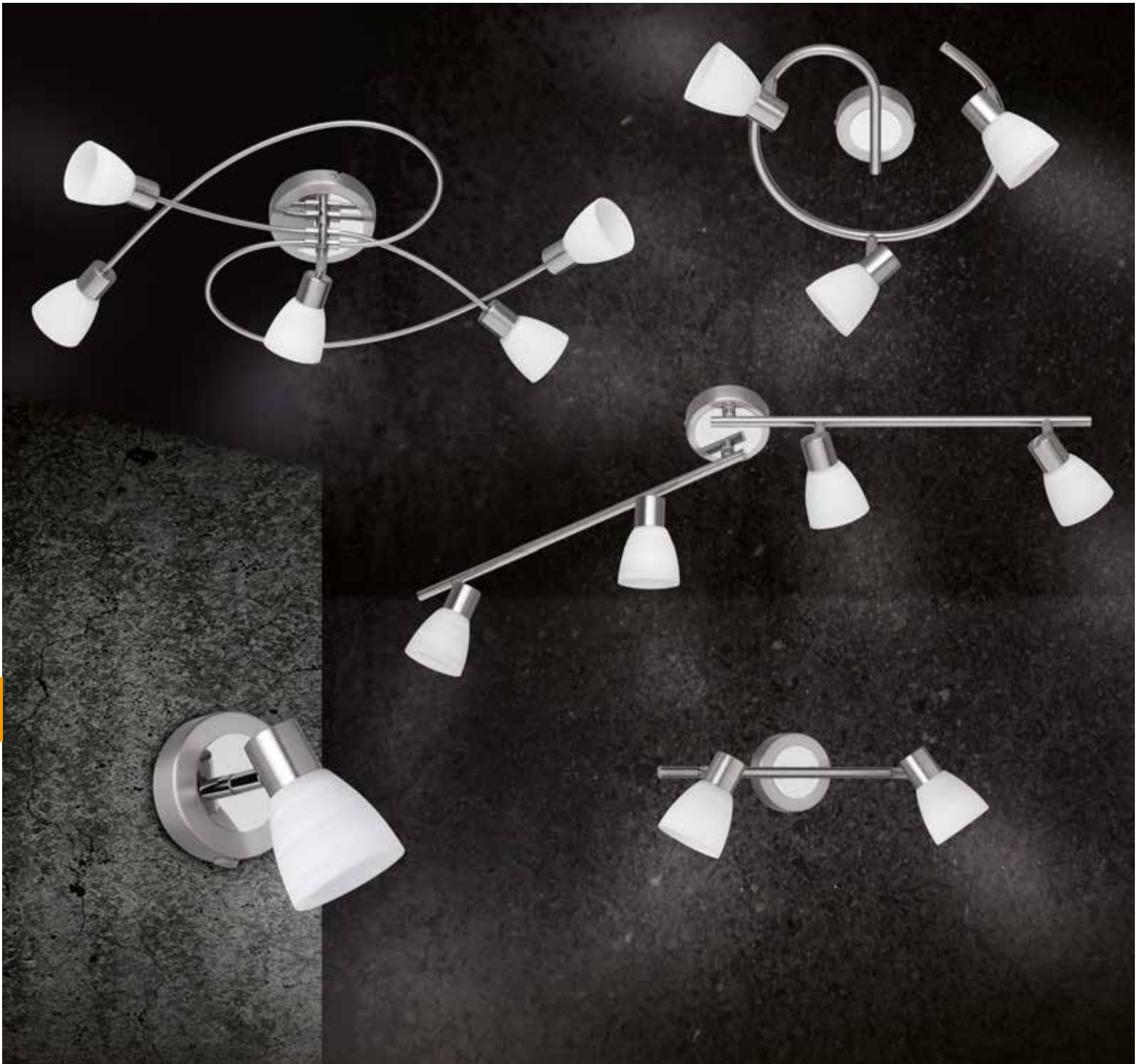

Strahler · Spot
 Ø 9 cm, ↗ 16 cm
 incl. 1 x LED G9, 3 W
 250 lm, 3.000 K



871570107



Strahler · Spot
 ↔ 34 cm, ↓ 18 cm
 incl. 2 x LED G9, 3 W
 2 x 250 lm, 3.000 K



871510207



Strahler · Spot
 Ø 29,5 cm, ↓ 18 cm
 incl. 3 x LED G9, 3 W
 3 x 250 lm, 3.000 K



871590307



Strahler · Spot
 ↔ 90 cm, ↓ 19 cm
 incl. 4 x LED G9, 3 W
 4 x 250 lm, 3.000 K



871510407



CARICO

Nickel matt, Glas Weiß gewischt · nickel mat, glass white brushed glass ·
 nickel mat, verre blanc balayé · nikkel mat, wit geborsteld glas ·
 níquel mate, blanco pulido · nichel opaco, vetro bianco spazzolato ·
 nichel mat, alb lucios · harjattu teräs, lasi harjattu valkoinen ·
 nikiel mat, szkło białe otarla



Dimmbar ·
Dimmable



Strahler · Spot
 ↔ 150 cm, ↑ 19 cm
 incl. 6 x LED G9, 3 W
 6 x 250 lm, 3.000 K



871510607



Strahler · Spot
 ↔ 73 x 34,5 cm, ↑ 21,5 cm
 incl. 5 x LED G9, 3 W
 5 x 250 lm, 3.000 K



671510507

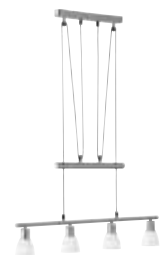

Pendelleuchte · Pendant
 ↔ 74,5 cm, ↑ 95 - 160 cm
 incl. 4 x LED G9, 3 W
 4 x 250 lm, 3.000 K



371510407

incl.: LED G9, 3 W
300 lm, 3.000 K





Pendelleuchte · Pendant
 ↔ 60,5 cm, ↓ 95 - 160 cm
 incl. 3 x LED E14, 5 W
 3 x 400 lm, 3.000 K



371010307
 371010308

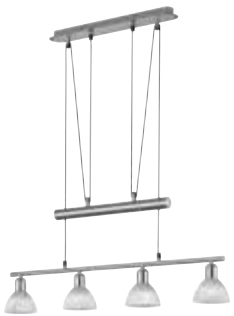

Pendelleuchte · Pendant
 ↔ 80 cm, ↓ 95 - 160 cm
 incl. 4 x LED E14, 5 W
 4 x 400 lm, 3.000 K



371010407
 371010408



07 | Nickel matt · nickel mat



08 | Messing matt · brass mat



Strahler · Spot
 Ø 10 cm, ↗ 19 cm
 incl. 1 x LED E14, 5 W
 400 lm, 3.000 K

871010107
 871010108



Strahler · Spot
 ↔ 33 cm, ↓ 19 cm
 incl. 2 x LED E14, 5 W
 2 x 400 lm, 3.000 K

871010207
 871010208



Strahler · Spot
 ↔ 55 cm, ↓ 19 cm
 incl. 3 x LED E14, 5 W
 3 x 400 lm, 3.000 K

871010307
 871010308



Strahler · Spot
 ↔ 88 cm, ↓ 19 cm
 incl. 4 x LED E14, 5 W
 4 x 400 lm, 3.000 K



871010407
 871010408





LEVISTO

Nickel matt oder Messing matt, Glas alabasterfarbig ·
 nickel mat or brass mat, alabaster-coloured glass · nickel mat ou laiton mat, verre couleur albâtre · nikkel mat of messing mat, albastkleurig glas ·
 níquel mate o bronze mate, vidrio de color alabastro · nichel opaco o ottone satinato, vetro colore alabastro · nichel mat sau bronz mat, sticla
 culoare alabastru · harjattu teräs tai mattamessinki, lasi alabasteri väri · nikiel mat lub mosiądz mat, szkło alabaster kolor



Strahler · Spot
 Ø 30 cm, ↑ 21 cm
 incl. 3 x LED E14, 5 W
 3 x 400 lm, 3.000 K

871090307
 871090308



Strahler · Spot
 ↔ 180 cm, ↑ 21 cm
 incl. 6 x LED E14, 5 W
 6 x 400 lm, 3.000 K

871010607
 871010608



incl.
 LED E14, 5 W
 400 lm, 3.000 K

983-60





Strahler · Spot
 Ø 52 cm, ↓ 19 cm
 incl. 3 x LED E14, 4 W
 3 x 320 lm, 3.000 K

624830307
 624830328



Strahler · Spot
 ↓ 13 x 10 cm, ↗ 19 cm
 incl. 1 x LED E14, 4 W
 320 lm, 3.000 K

824810107
 824810128



Strahler · Spot
 ↔ 31 cm, ↓ 20 cm
 incl. 2 x LED E14, 4 W
 2 x 320 lm, 3.000 K

824810207
 824810228



Strahler · Spot
 ↔ 45 cm, ↓ 20,5 cm
 incl. 3 x LED E14, 4 W
 3 x 320 lm, 3.000 K

824810307
 824810328



Strahler · Spot
 ↔ 60 cm, ↓ 20,5 cm
 incl. 4 x LED E14, 4 W
 4 x 320 lm, 3.000 K



824810407
 824810428



Pendelleuchte · Pendant
 ↔ 78 cm, ↑ 85 - 180 cm
 incl. 4 x LED E14, 4 W
 4 x 320 lm, 3.000 K



324810407
 324810428



Tischleuchte · Table lamp
 ↓ 40 cm, ↗ 28 cm
 incl. 1 x LED E14, 4 W
 320 lm, 3.000 K



524810107
 524810128



FREDDY

Nickel matt oder rostfarbig, Glas matt · nickel mat or rusty, mat glass ·
 nickel mat ou rouille, verre mat · nikkel mat of roestkleur, mat glas ·
 níquel mate o óxido, vidrio mate · nichel opaco o ruggine, vetro sabbiato ·
 nichel mat sau ruginiu, sticla mata · harjattu teräs tai rustiikki, mattalasi ·
 nikiel mat lub miedz, szkło matowane



incl.
 LED E14, 4 W
 320 lm, 3.000 K

983-40



07 | Nickel matt · nickel mat



28 | rostfarbig antik · antique rust



Stehleuchte · Floor lamp
 ↑ 125 cm, ↗ 55 cm
 incl. 2 x LED E14, 4 W
 2 x 320 lm, 3.000 K



424810207
424810228



Stehleuchte · Floor lamp
 ↑ 150 cm, ↗ 55 cm
 incl. 1 x LED E14, 4 W
 320 lm, 3.000 K



424810107
424810128



Empfohlen:
recommended: LED E14, 5 W
400 lm, 3.000 K



983-60

TRUMPET

Altmessing, Glas Weiß · old brass, glass white ·
laiton fumé, verre blanc · oud brons, glas wit · bronze viejo, vidrio blanco ·
ottone invecchiato, vetro bianco · bronz antic, sticla alb · antiikkimessinki, lasi valkoinen · patyna, szkło biały



Strahler · Spot
Ø 9 cm, √ 17 cm
excl. 1 x E14, max. 40 W



803100104



Strahler · Spot
↔ 26 cm, ↓ 19,5 cm
excl. 2 x E14, max. 40 W



803100204



Strahler · Spot
↔ 41 cm, ↓ 19,5 cm
excl. 3 x E14, max. 40 W



803100304



Strahler · Spot
↔ 68 cm, ↓ 19,5 cm
excl. 4 x E14, max. 40 W



803100404



Empfohlen:
recommended: Filament LED E14, 4 W
470 lm, 3.000 K



989-400

HOUSTON

Metall, Schwarz/goldfarbig · metal, black/gold ·
metale, noir/ro · metaal, zwart/goud · metal, negro/oro ·
metallo, nero/oro · metal, negru/aur · metalli, musta/kultaa ·
metal, czarny/złota



Strahler · Spot
↔ 9,5 x 12 cm, ↗ 17 cm
excl. 1 x E14, max. 40 W



800300132



Strahler · Spot
↔ 36,5 cm, ↓ 19 cm
excl. 2 x E14, max. 40 W



800300232



Strahler · Spot
↔ 69,5 cm, ↓ 19 cm
excl. 4 x E14, max. 40 W



800300432







546 - 569

2-Phasen- Schienensystem

2-phase track system

Système de voie à deux phases

2-fase-spoorsysteem

Sistema de rieles en 2 fases

Sistema a binario bifase

Sistem de piste cu 2 faze

2-vaihekiskojärjestelmä

2-fazowy system prowadnic

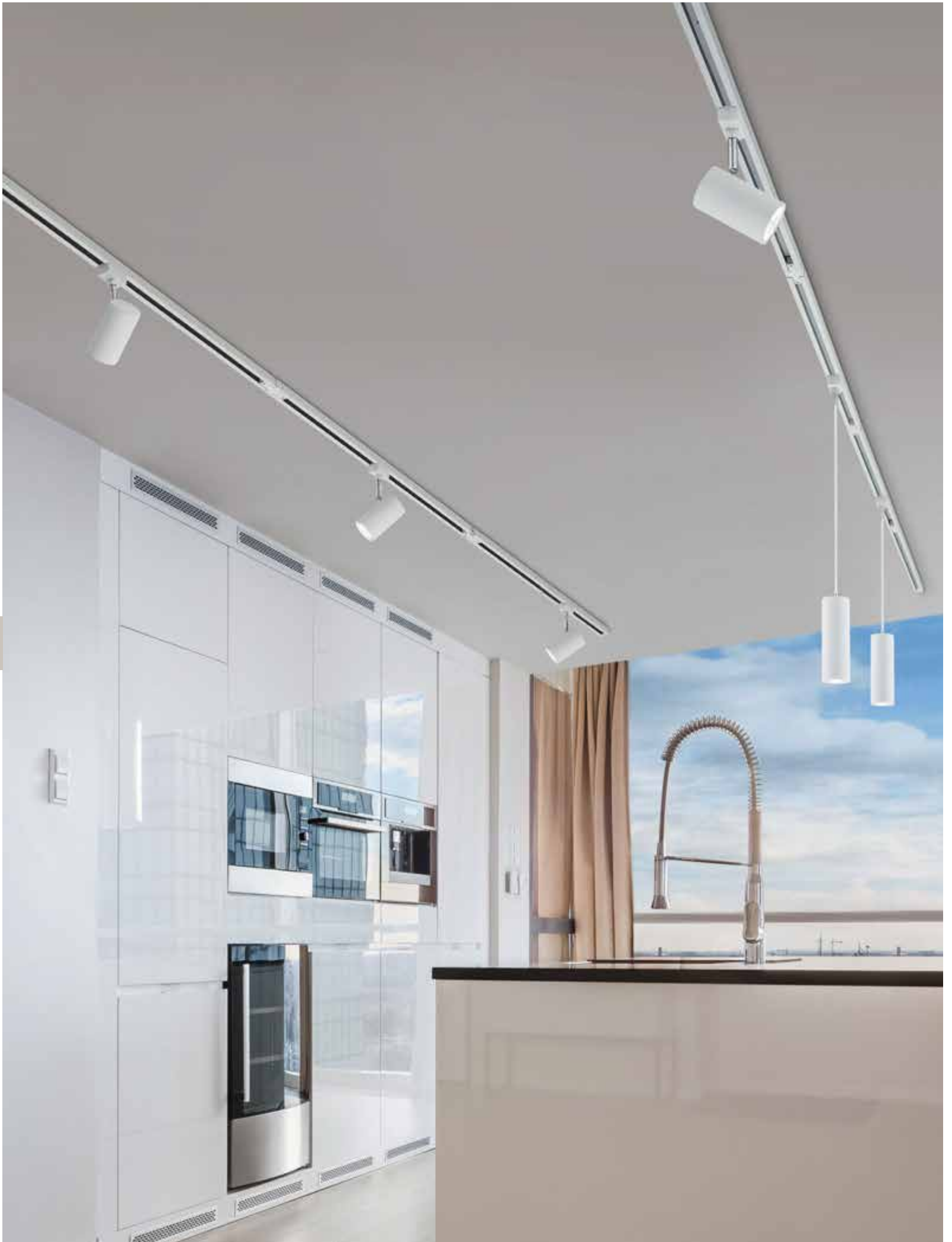

Für jede Raumsituation die ideale Beleuchtung.

Das DUOline 2-Phasen-Schiensystem ist äußerst flexibel und bietet zahlreiche Möglichkeiten zur individuellen Lichtgestaltung. Die verschiedenen Spots und Pendelleuchten lassen sich frei in der Schiene platzieren und können so gezielt in allen Wohnbereichen eingesetzt werden. Das 2-Phasensystem ermöglicht, dass mit nur einem Stromanschluss zwei Beleuchtungsgruppen getrennt voneinander geschaltet oder gedimmt werden können.

Bitte beachten! Um das 2-Phasensystem nutzen zu können, wird eine vieradrige Stromleitung benötigt.

The ideal lighting for every room situation.

The DUOline 2-phase track system is extremely flexible and offers numerous possibilities for individual lighting arrangements. The various spotlights and pendant lamps can be positioned as desired in the track and can therefore be used in all living areas. The 2-phase system allows two lighting groups to be switched or dimmed independently of each other with just one power connection.

Please note! A four-core power cable is required to be able to use the 2-phase system.

L'éclairage parfait pour chaque type de pièces.

Le système de rails biphasés DUOline est extrêmement flexible et offre de nombreuses possibilités de conception individuelle de l'éclairage. Les différents projecteurs et luminaires suspendus peuvent être positionnés librement dans le rail et peuvent donc être utilisés de manière spécifique dans tous vos espaces d'habitation. Le système biphasé permet de commuter ou de faire varier l'intensité de deux groupes d'éclairage séparément l'un de l'autre avec un seul branchement électrique.

Attention ! Un câble d'alimentation à quatre conducteurs est nécessaire pour utiliser le système biphasé.

Voor elke situatie de ideale verlichting.

Het DUOline-2-fase-spoorsysteem is uiterst flexibel en biedt talrijke mogelijkheden voor een individuele lichtvormgeving. De diverse spots en hanglampen kunnen willekeurig in het spoor geplaatst worden en kunnen zo doelgericht in alle woonruimtes gebruikt worden. Het 2-fase-systeem maakt mogelijk dat met slechts één stroomaansluiting twee verlichtingsgroepen apart van elkaar geschakeld of gedimd kunnen worden.

Opgelet! Om het 2-twee-fasesysteem te kunnen gebruiken is een vierdradige stroomleiding nodig.

La iluminación ideal para cada habitación.

El sistema de rieles en 2 fases DUOline es extraordinariamente flexible y ofrece numerosas posibilidades de diseño lumínico individuales. Los distintos puntos y lámparas de péndulo le permiten colocar los rieles libremente y por eso pueden utilizarse en toda la vivienda. El sistema de rieles en 2 fases permite que se activen o atenúen dos grupos de lámparas separados con un solo cable de corriente.

¡Por favor, recuerde! Para poder utilizar el sistema en 2 fases, será necesario un cable de corriente de cuatro filamentos.

L'illuminazione ideale per qualsiasi esigenza abitativa.

Il sistema a binario bifase DUOline è estremamente flessibile e offre numerose possibilità per la progettazione individuale dell'illuminazione. I vari faretti e lampade a sospensione possono essere posizionati liberamente nel binario e possono quindi essere utilizzati in modo specifico in tutti gli ambienti abitativi. Il sistema bifase consente di commutare o dimmerare due gruppi di illuminazione separatamente l'uno dall'altro con una sola connessione di alimentazione.

Attenzione! Per utilizzare il sistema bifase è necessario un cavo di alimentazione a quattro conduttori.

Iluminatul ideal pentru fiecare încăpere.

Sistemul de piste cu 2 faze DUOline este deosebit de flexibil și oferă numeroase posibilități pentru structurarea individuală a luminii. Diferitele spot-uri și lustre pot fi amplasate liber pe pistă și pot fi astel utilizate ținut în toate zonele spațiilor de locuit. Sistemul cu 2 faze permite comutarea și reglarea intensității pentru două grupuri de corpuri de iluminat separate, folosind un singur racord electric.

Vă rugăm să aveți în vedere! Pentru a putea utiliza sistemul cu 2 faze, este necesară utilizarea unui cablu electric cu patru fire.

Ihanteellinen valaistus jokaiseen huoneen käyttötilanteeseen.

DUOline 2-vaihekiskojärjestelmä on erittäin joustava ja tarjoaa lukuisia vaihtoehtoja yksilölliseen valaistuksen suunnitteluun. Eri spotti- ja ripustettavat valaisimet voidaan sijoittaa mihin tahansa kiskoon, joten niitä voidaan käyttää kaikissa asuintiloissa. 2-vaihejärjestelmä mahdollistaa kahden valaistusryhmän kytkemisen tai himmentämisen erikseen yhdellä sähköliitännällä.

Huomaa! Kaksivaihejärjestelmän käyttämiseksi tarvitaan nelijohtiminen sähkönsyöttö.

Idealne oświetlenie do każdej sytuacji w pomieszczeniu.

Dwufazowy system prowadnic DUOline jest niezwykle elastyczny i oferuje wiele opcji indywidualnego projektowania oświetlenia. Różne skupienia i lampy wiszące można umieścić w dowolnym miejscu na szynie, dzięki czemu można je stosować we wszystkich pomieszczeniach mieszkalnych. System 2-fazowy umożliwia osobne przełączanie lub przyciemnianie dwóch grup oświetlenia za pomocą tylko jednego podłączenia zasilania.

Proszę pamiętać! Dla korzystania z systemu 2-fazowego, wymagana jest czteroprzewodowa linia zasilania.

ÜBERSICHT KOMPONENTEN

Component overview · Aperçu des composants · Overzicht van componenten ·
Vista general por componentes · Panorâmica dei componentes · Prezentare generală a componentelor ·
Komponentteihin yleiskuvaus · Przegląd komponentów

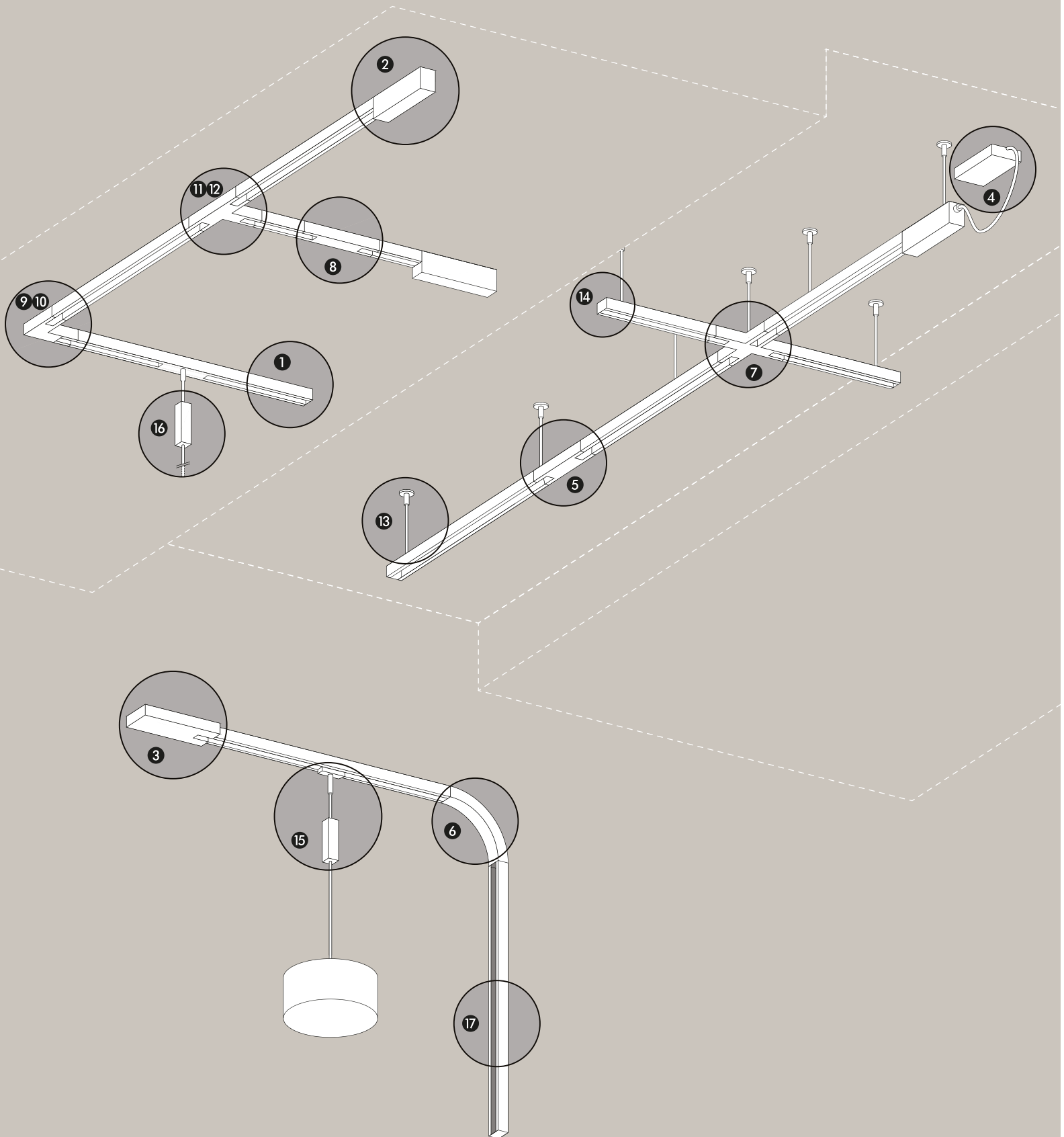

Die Vorteile von DUOline im Überblick:

- Individuelle Lichtgestaltung
- Nur ein Stromanschluss erforderlich
- Kein Trafo notwendig
- Leuchten frei kombinierbar und leicht versetzbar
- Zwei verschiedene Lichtszenarien
- Getrenntes Schalten und Dimmen
- Für Decken- und Wandmontage geeignet

Bei der Planung bitte unbedingt die Position des Schutzleiters beachten, der innerhalb des Systems durchgängig verbunden sein muss.

Advantages of DUOline at a glance:

- individual lighting arrangements
- only one power connection required
- no need for a transformer
- lamps can be freely combined and are easily positioned
- two different lighting scenarios
- separate switching and dimming
- suitable for ceilings and walls

When planning, please pay attention to the position of the protective conductor, which must be connected continuously within the system.

Les avantages de DUOline en un coup d'œil :

- Conception individuelle de l'éclairage
- Une seule connexion électrique requise
- Pas besoin de transformateur
- Les luminaires peuvent être librement combinés et facilement déplacés
- Deux scénarios lumineux différents
- Commutation et variateur de lumière séparés
- Convient pour le montage au plafond et au mur

Lors de la planification, veuillez prêter une attention particulière à la position du conducteur de protection, qui doit être connecté en permanence dans le système.

Overzicht van de voordelen van DUOline:

- Individuele lichtvormgeving
- Slechts één stroomaansluiting nodig
- Geen transformator nodig
- Lampen willekeurig combineerbaar en gemakkelijk verplaatsbaar
- Twee verschillende lichtscenario's
- Apart schakelen en dimmen
- Geschikt voor plafond- en muurmontage

Let bij de planning absoluut op de positie van de beschermende geleider die binnen het systeem ononderbroken verbonden moet zijn.

Las ventajas de DUOline en resumen:

- Diseño lumínico individual
- Solo un cable de corriente necesario
- Ningún transformador necesario
- Lámpara combinables libremente y fácilmente desplazable
- Dos escenarios lumínicos diferentes
- Activación y atenuación separadas
- Adecuado para su montaje en techo y pared

Al planificar, por favor, tenga en cuenta la posición de la toma de tierra, que debe estar conectado a lo largo de todo el sistema.

I vantaggi di DUOline in sintesi:

- Progettazione individuale dell'illuminazione
- È necessario un solo collegamento di alimentazione
- Non è necessario alcun trasformatore
- Le lampade possono essere liberamente combinate e facilmente spostate
- Due differenti scenari di illuminazione
- Commutazione e dimmerazione separate
- Adatto per il montaggio a soffitto e a parete

In fase di progettazione, prestare attenzione alla posizione del conduttore di protezione, che deve essere collegato in modo continuo all'interno dell'impianto.

Avantajele DUOline dintr-o privire:

- Structurarea individualizată a luminii
- Este necesară o singură conexiune electrică
- Nu este necesar un transformator
- Lămpile pot fi combinate liber și pot fi deplasate cu ușurință
- Două scenarii de iluminat diferite
- Comutare și reglare a intensității separate
- Adecvat pentru montajul pe plafon și pe perete

La planificare, luați neapărat în considerare poziția conductorului de protecție, care trebuie să fie conectat continuu în interiorul sistemului.

DUOlinen edut lyhyesti:

- Yksilöllinen valaistussuunnittelu
- Vaaditaan vain yksi sähköliitäntä
- Muuntajaa ei tarvita
- Valaisimia voidaan yhdistellä vapaasti ja siirtää helposti
- Kaksi erilaista valaistusskenaariota
- Erillinen kytkentä ja himmennys
- Sopii katto- ja seinäasennukseen

Huomioi suunnittelussa koko järjestelmään kytkettävän suojamaadoituksen sijainti.

Zalety DUOline w skrócie:

- Indywidualny projekt oświetlenia
- Wymagane jest tylko jedno połączenie zasilania
- Nie wymaga transformatora
- Oprawy można dowolnie łączyć i łatwo przemieszczać
- Dwa różne scenariusze oświetlenia
- Oddzielne włączanie i ściemnianie
- Nadaje się do montażu sufitowego i ściennego

Podczas projektowania należy zwrócić uwagę na położenie przewodu ochronnego, który musi być podłączony w całym systemie.

SCHIENE · TRACK

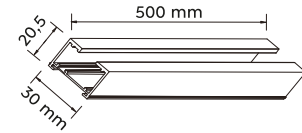

1 SCHIENE 50 CM · TRACKING 50 CM

Metall · metal
max. 2 x 600 W

700131 | Weiß matt · white mat
700132 | Schwarz matt · black mat
700187 | titanfarbig · titan

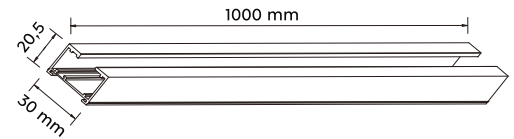

1 SCHIENE 100 CM · TRACKING 100 CM

Metall · metal
max. 2 x 600 W

700231 | Weiß matt · white mat
700232 | Schwarz matt · black mat
700287 | titanfarbig · titan

Die maximale Montagelänge beträgt 30 Meter pro Einspeisung, bei einer Gesamtleistung von max. 600 Watt pro Phase.
The maximum installation length is 30 metres per power feed, with a total capacity of max. 600 watts per phase.

EINSPEISUNG · POWER SUPPLY

552

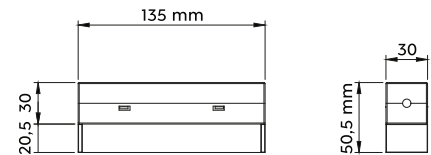

2 MITTEL-/END-EINSPEISUNG · MIDDLE-/ENDPOINT POWER SUPPLY

Kunststoff · plastic
max. 2 x 600 W

701031 | Weiß matt · white mat
701032 | Schwarz matt · black mat
701087 | titanfarbig · titan

Die Mittel-/Endeinspeisung wird direkt über dem Stromauslass angebracht und ermöglicht, Schienen auf einer Seite oder auf beiden Seiten anzuschließen.
The middle/end feed is mounted directly over the power outlet and enables tracks to be connected on one or both sides.

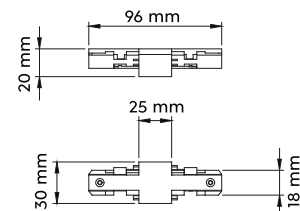

3 MITTEL-/END-EINSPEISUNG MIT ELEKTRONISCHEM PHASENWECHSLER · MIDDLE-/ENDPOINT POWER SUPPLY WITH ELECTRONIC PHASE CHANGER

Kunststoff · plastic
max. 2 x 200 W

701131 | Weiß matt · white mat
701132 | Schwarz matt · black mat
701187 | titanfarbig · titan

Mittels elektronischem Phasenwechsler lassen sich die zwei Phasen auch bei dreidadrigen Stromleitungen getrennt Schalten und Dimmen.
Using an electronic phase changer, the two phases can be switched and dimmed separately, even with three-core power cables.

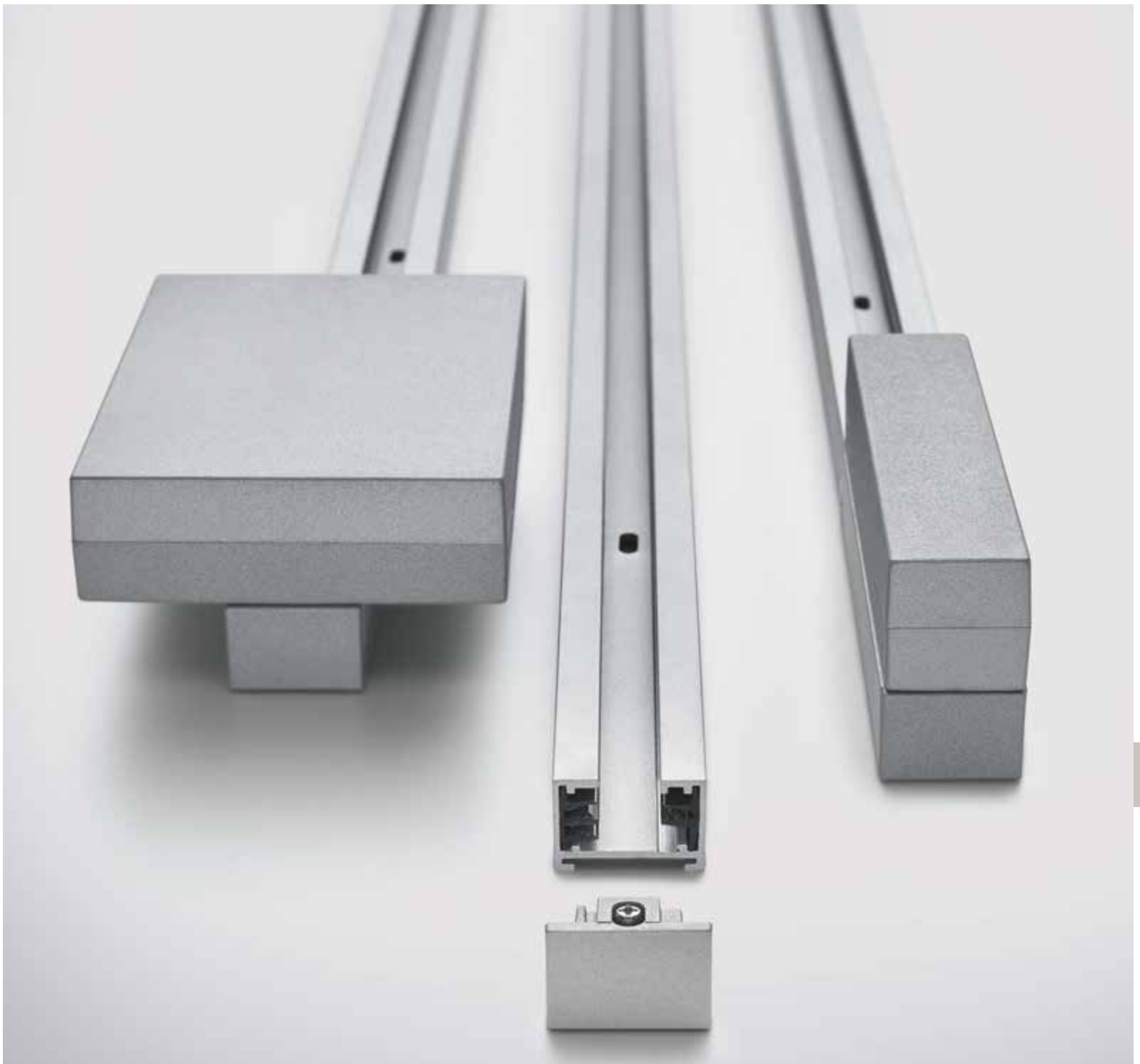

4 FLEXIBLE STROMVERSORGUNG · FLEX POWER SUPPLY

Kunststoff · plastic
max. 2 x 600 W

701231 | Weiß matt · white mat
701232 | Schwarz matt · black mat
701287 | titanfarbig · titan

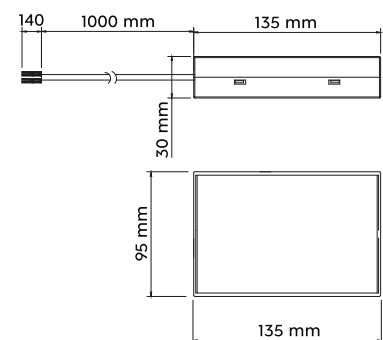

Die flexible Stromversorgung wird benötigt, wenn die Schienen nicht direkt über den Stromauslass verlegt werden können.
The flexible power supply is required if the rails cannot be mounted directly over the power outlet.



VERBINDER · CONNECTOR



31



32



87

5 LÄNGSVERBINDER · LINE CONNECTOR

Kunststoff · plastic
max. 2 x 600 W

702131 | Weiß matt · white mat
702132 | Schwarz matt · black mat
702187 | titanfarbig · titan

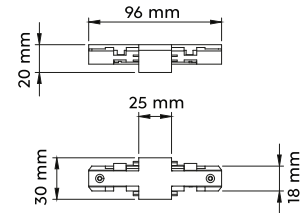

Verbindet zwei Schienen für gerade Strecken miteinander.
Connects two rails together for straight sections.



31



32



87

6 FLEX-VERBINDER · FLEX CONNECTOR

Kunststoff · plastic
max. 2 x 600 W

702031 | Weiß matt · white mat
702032 | Schwarz matt · black mat
702087 | titanfarbig · titan

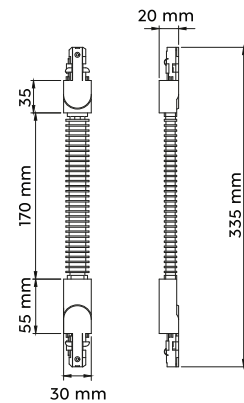

Verbindet zwei Schienen in einem beliebigen Winkel miteinander und ermöglicht die Verbindung zwischen Decken- und Wandmontage.
Connects two rails together at any angle and makes possible a connection between ceiling and wall mounting.

555



31



32



87

7 X-VERBINDER · X-CONNECTOR

Kunststoff · plastic
max. 2 x 600 W

702431 | Weiß matt · white mat
702432 | Schwarz matt · black mat
702487 | titanfarbig · titan

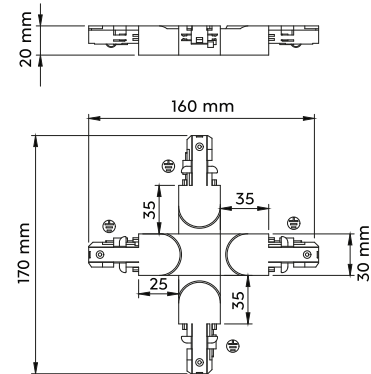

Verbindet vier Schienen im rechten Winkel miteinander.
Connects four tracks together at right angles to each other.



31



32



87

8 ISOLATOR · ISOLATOR

Kunststoff · plastic
max. 2 x 600 W

702531 | Weiß matt · white mat
702532 | Schwarz matt · black mat
702587 | titanfarbig · titan

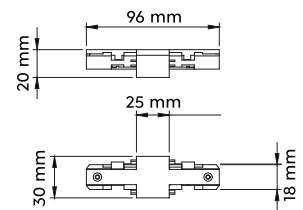

Mittels Isolator können zwei separate Schaltkreise optisch zu einem System verbunden werden.
Using an isolator, two separate circuits can be optically connected to form one system.

Bei der Planung bitte unbedingt die Position des Schutzleiters beachten, der innerhalb des Systems durchgängig verbunden sein muss.

When planning, please pay attention to the position of the protective conductor, which must be connected continuously within the system.

Lors de la planification, veuillez prêter une attention particulière à la position du conducteur de protection, qui doit être connecté en permanence dans le système.

Let bij de planning absoluut op de positie van de beschermende geleider die binnen het systeem ononderbroken verbonden moet zijn.

Al planificar, por favor, tenga en cuenta la posición de la toma de tierra, que debe estar conectado a lo largo de todo el sistema.

In fase di progettazione, prestare attenzione alla posizione del conduttore di protezione, che deve essere collegato in modo continuo all'interno dell'impianto.

La planificare, luați neapărat în considerare poziția conductorului de protecție, care trebuie să fie conectat continuu în interiorul sistemului.

Huomioi suunnittelussa koko järjestelmään kytkettävän suojausjohtuksen sijainti.

Podczas projektowania należy zwrócić uwagę na położenie przewodu ochronnego, który musi być podłączony w całym systemie.

Beispiel A
Example A.

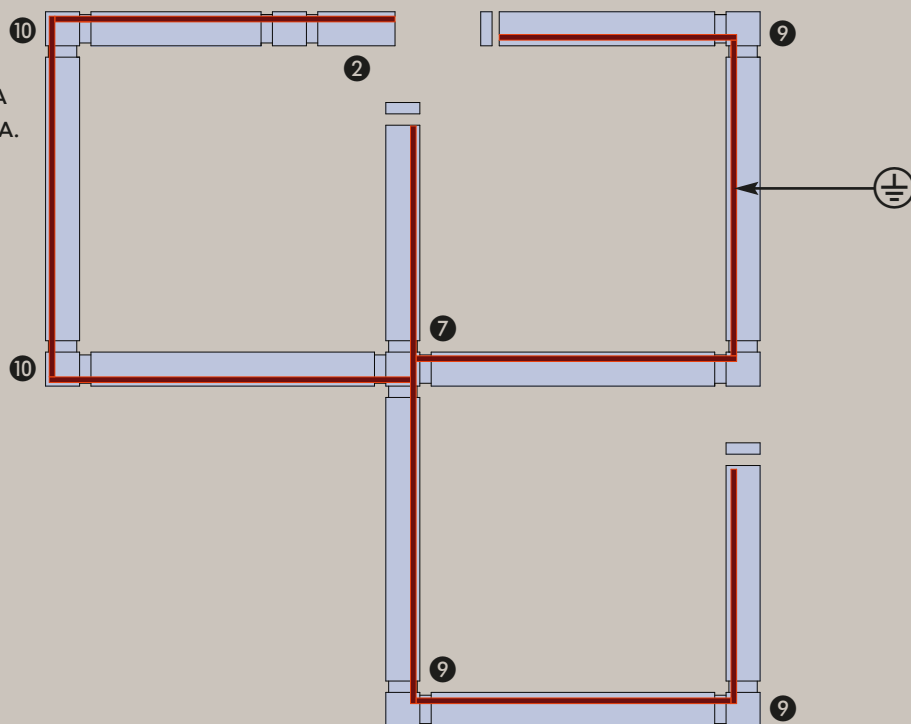

Beispiel B
Example B.

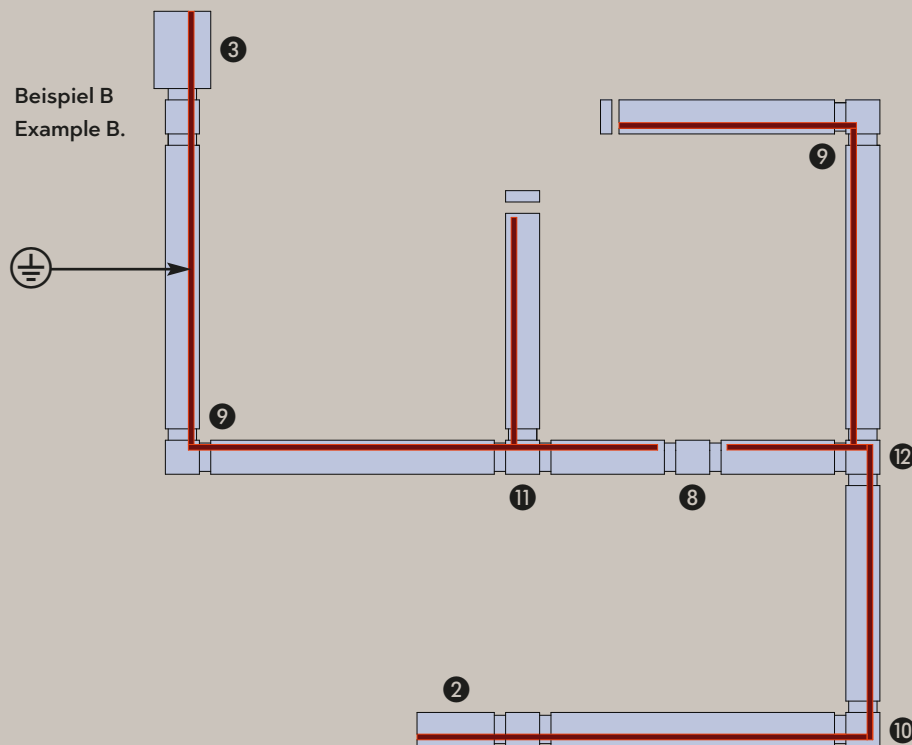



31



32



87

9 L-VERBINDER - SCHUTZLEITER INNEN · L-CONNECTOR - INNER PROTECTIVE CONDUCTOR

Kunststoff · plastic
max. 2 x 600 W

702231 | Weiß matt · white mat
702232 | Schwarz matt · black mat
702287 | titanfarbig · titan

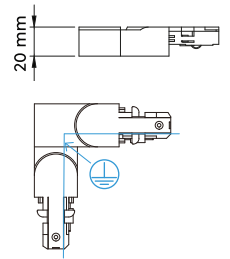
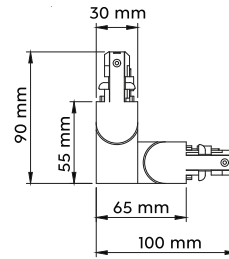

31



32



87

10 L-VERBINDER (TYP A) - SCHUTZLEITER AUSSEN · L-CONNECTOR (TYPE A) - OUTER PROTECTIVE CONDUCTOR

Kunststoff · plastic
max. 2 x 600 W

702231A | Weiß matt · white mat
702232A | Schwarz matt · black mat
702287A | titanfarbig · titan

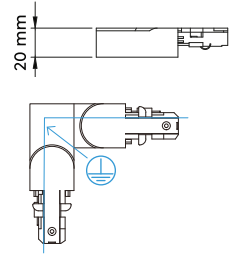
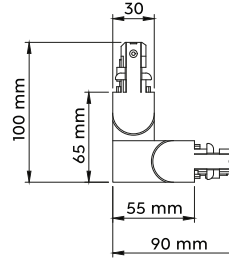

Verbindet zwei Schienen im rechten Winkel miteinander.
Connects two rails together at right angles.



31



32



87

11 T-VERBINDER - SCHUTZLEITER RECHTS · T-CONNECTOR - RIGHT PROTECTIVE CONDUCTOR

Kunststoff · plastic
max. 2 x 600 W

702331 | Weiß matt · white mat
702332 | Schwarz matt · black mat
702387 | titanfarbig · titan

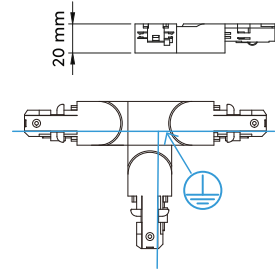
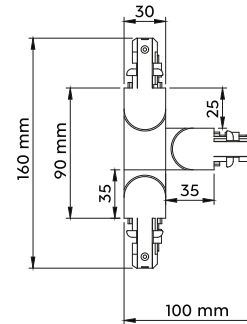

31



32



87

12 T-VERBINDER (TYP A) - SCHUTZLEITER LINKS · T-CONNECTOR (TYPE A) - LEFT PROTECTIVE CONDUCTOR

Kunststoff · plastic
max. 2 x 600 W

702331A | Weiß matt · white mat
702332A | Schwarz matt · black mat
702387A | titanfarbig · titan

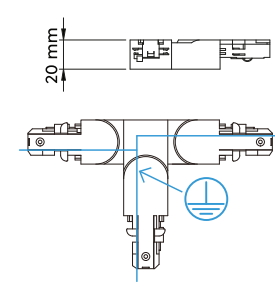
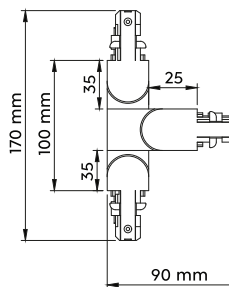

Verbindet zwei Schienen im rechten Winkel miteinander.
Connects two rails together at right angles.

ZUBEHÖR · ACCESSORIES



31



32



87

13 DISTANZHALTER SET · SUSPENSION SET

Kunststoff · plastic

- 703131 | Weiß matt · white mat
- 703132 | Schwarz matt · black mat
- 703187 | titanfarbig · titan

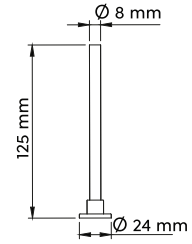

31



32



87

13 DISTANZHALTER SET · SUSPENSION SET

Kunststoff · plastic

- 703231 | Weiß matt · white mat
- 703232 | Schwarz matt · black mat
- 703287 | titanfarbig · titan

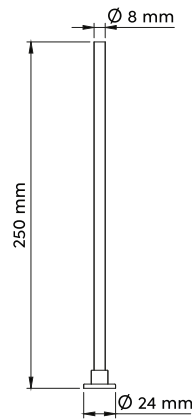

558



31



32



87

14 ENDKAPPEN · END CAPS

Kunststoff · plastic

- 703031 | Weiß matt · white mat
- 703032 | Schwarz matt · black mat
- 703087 | titanfarbig · titan

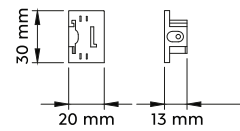

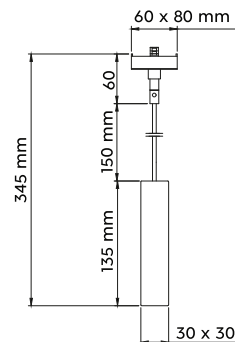

15 PENDEL-ADAPTER · PENDULAR ADAPTER

Kunststoff · plastic
max. 60 W

- 703531 | Weiß matt · white mat
- 703532 | Schwarz matt · black mat
- 703587 | titanfarbig · titan

Dieser Pendel-Adapter ermöglicht es, herkömmliche Pendelleuchten in das DUOline Schienensystem zu integrieren.
This pendular adapter makes it possible for conventional pendular lamps to be integrated into the DUOline track system.

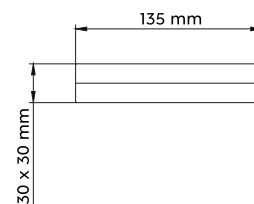

16 KABELKÜRZER · CABLE SHORTENER

Kunststoff · plastic

- 703331 | Weiß matt · white mat
- 703332 | Schwarz matt · black mat
- 703387 | titanfarbig · titan



559

Ermöglicht das Kürzen der Kabel von Pendelleuchten.
Makes a shortening of the pendal lamp cable possible.



17 ABDECKSCHIENE · SAFETY COVER STRIP

Kunststoff · plastic
↔ 100 x 1,4 cm, ∠ 0,5 cm

703952 | Transparent · transparent



ABDECKPLATTE · COVER PLATE

Metall · metal
↑ 0,1 cm, Ø 10m

703431 | Weiß matt · white mat

RADIATOR

Metall · metal · metale · metaal · metal · metallo · metal · metalli · metal



STRAHLER · SPOT
incl. SMD-LED, 15 W
1.270 lm, 2.300 + 3.000 + 4.000 K



78030131 | Weiß matt · white mat
78030132 | Schwarz matt · black mat
78030187 | titanfarbig · titan

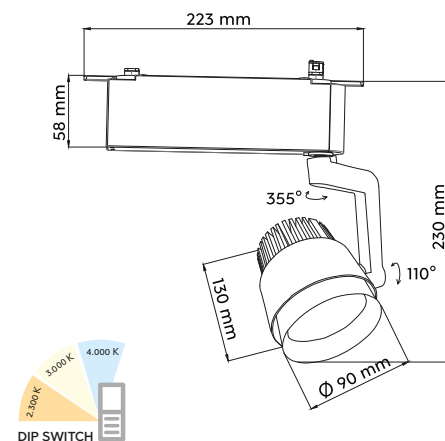

LEON

Metall · metal · metale · metaal · metal · metallo · metal · metalli · metal



STRAHLER · SPOT
excl. 1 x GU10, max. 25 W



78070107 | Nickel matt · nickel mat
78070131 | Weiß matt · white mat
78070132 | Schwarz matt · black mat

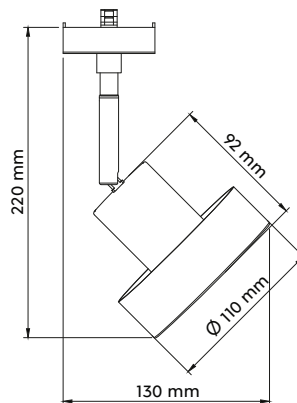

ROUBAIX

Metall · metal · metale · metaal · metal · metallo · metal · metalli · metal



STRAHLER · SPOT
incl. SMD-LED, 4 W
400 lm, 3.000 K



78150107 | Nickel matt · nickel mat
78150131 | Weiß matt · white mat
78150132 | Schwarz matt · black mat

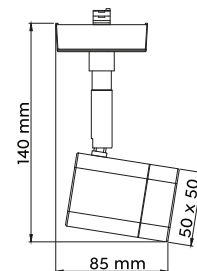





MARLEY

Metall · metal · metale · metaal · metal · metallo · metal · metalli · metal

562



07



31



32

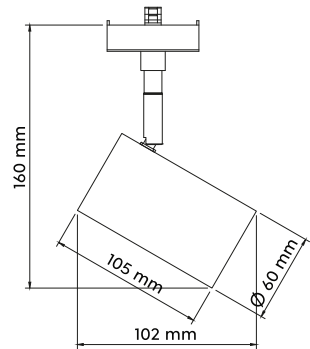

STRAHLER · SPOT
excl. 1 x GU10, max. 25 W



- 78240107 | Nickel matt · nickel mat
- 78240131 | Weiß matt · white mat
- 78240132 | Schwarz matt · black mat



07



31



32

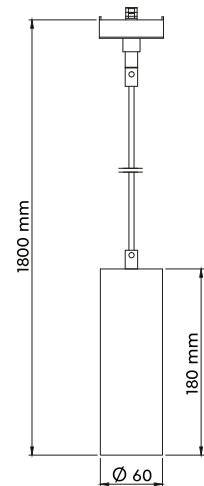

PENDELLEUCHE · PENDANT
excl. 1 x GU10, max. 25 W



- 73240107 | Nickel matt · nickel mat
- 73240131 | Weiß matt · white mat
- 73240132 | Schwarz matt · black mat



PAROS

Metall · metal · metale · metaal · metal · metallo · metal · metalli · metal



07



31



32

PENDELLEUCHE · PENDANT
incl. SMD-LED, 32 W
3.200 lm, 3.000 K

- 73043107 | Nickel matt · nickel mat
- 73043131 | Weiß matt · white mat
- 73043132 | Schwarz matt · black mat

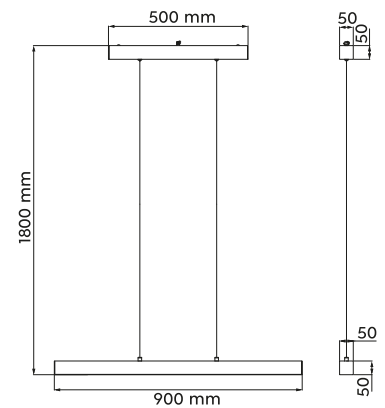

ANTIBES

Metall, Glas Weiß · metal, glass white · metale, verre blanc · metaal, glas wit · metal, vidrio blanco · metallo, vetro bianco · metal, sticla alb · metalli, lasi valkoinen · metal, szkło biały

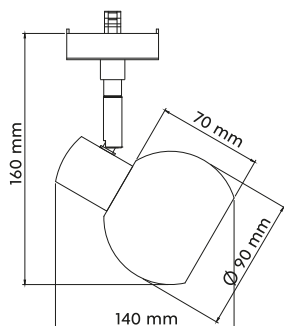

STRAHLER · SPOT
excl. 1 x GU10, max. 25 W



78170107 | Nickel matt · nickel mat

ONTARIO

Glas Weiß · glass white · verre blanc · glas wit · vidrio blanco · vetro bianco · sticla alb · lasi valkoinen · szkło biały

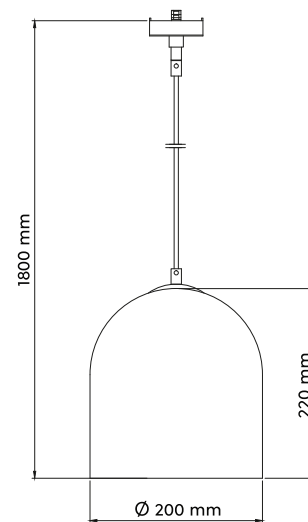

PENDELLEUCHE · PENDANT
excl. 1 x E14, max. 25 W



73520101 | weiß · white

DIALLO

Metall · metal · metale · metaal · metal · metallo · metal · metalli · metal

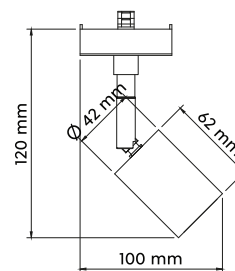

STRAHLER · SPOT
excl. 1 x E27, max. 25 W



78010107 | Nickel matt · nickel mat
78010131 | Weiß matt · white mat
78010132 | Schwarz matt · black mat

TOSH

Metall, Holz · metal, wood · metale, bois · metaal, hout · metal, madera · metallo, di legno · metal, lemn · metalli, puu · metal, drewno

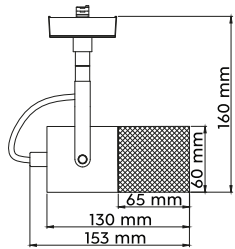

STRAHLER · SPOT
excl. 1 x E14, max. 25 W



78430132 | Schwarz matt · black mat

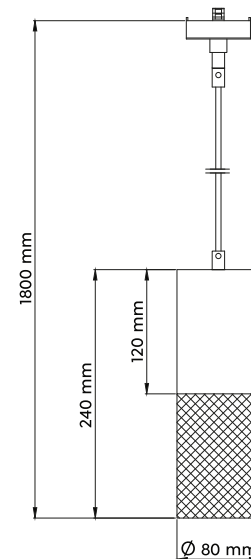

PENDELLEUCHE · PENDANT
excl. 1 x E27, max. 25 W



73430132 | Schwarz matt · black mat



PANEL

Kunststoff · plastic · plastique · kunststof · plástico · plastica · plastic · muovi · plastik

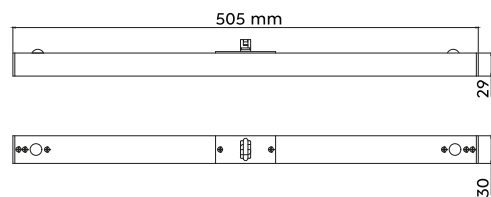

LED-PANEL
incl. SMD-LED, 6 W
850 lm, 3.000 K



- 77020131 | Weiß matt · white mat
- 77020132 | Schwarz matt · black mat
- 77020187 | titanfarbig · titan

CAMILLUS

Kunststoff · plastic · plastique · kunststof · plástico · plastica · plastic · muovi · plastik

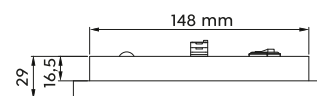

LED-PANEL
incl. SMD-LED, 9 W
900 lm, 3.000 K



- 76921031 | Weiß matt · white mat
- 76921032 | Schwarz matt · black mat
- 76921087 | titanfarbig · titan

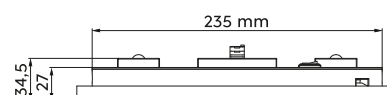

LED-PANEL
incl. SMD-LED, 14,5 W
1.500 lm, 3.000 K



- 76921531 | Weiß matt · white mat
- 76921532 | Schwarz matt · black mat
- 76921587 | titanfarbig · titan



HOTEL

Stoffschild · fabric shade · abat-jour tissu · Stoffen kap · Pantalla de tela · paralume in tessuto · abajur textil · kangas varjostin · Klosz z materiału



DECKENLEUCHE · CEILING LAMP
excl. 2 x E27, max. 25 W



76390201 | Weiß · white
76390211 | Grau · grey

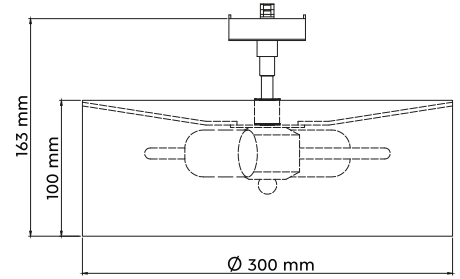

PENDELLEUCHE · PENDANT
excl. 1 x E27, max. 25 W



73330101 | Weiß · white
73330111 | Grau · grey

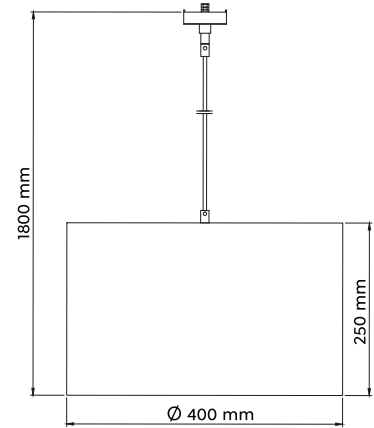

TOMMY

Stoffschild · fabric shade · abat-jour tissu · Stoffen kap · Pantalla de tela · paralume in tessuto · abajur textil · kangas varjostin · Klosz z materiału

568



STRAHLER · SPOT
excl. 1 x E14, max. 25 W



78330101 | Weiß · white
78330111 | Grau · grey
78330179 | goldfarbig · gold

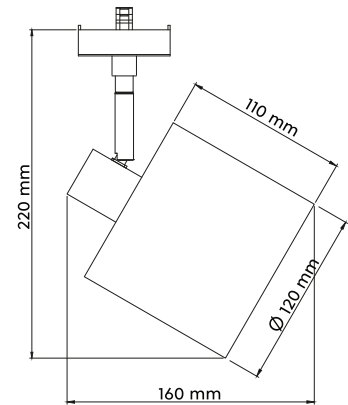

JIMMY

Metall, Schwarz · metal, black · metale, noir · metaal, zwart · metal, negro · metallo, nero · metal, negro · metalli, musta · metal, czarny



PENDELLEUCHE · PENDANT
excl. 1 x E27, max. 25 W



73120102 | Schwarz-Gold · black-gold

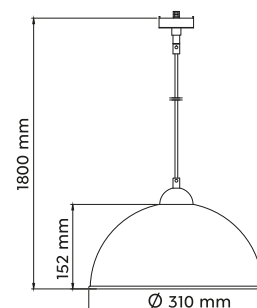



HOSTEL

Stoffschild · fabric shade · abat-jour tissu · Stoffen kap · Pantalla de tela · paralume in tessuto · abajur textil · kangas varjostin · Klosz z materiału

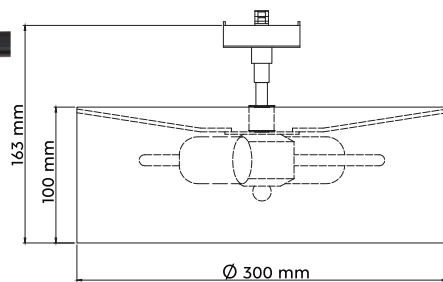

DECKENLEUCHTE · CEILING LAMP
excl. 2 x E27, max. 25 W

76820280 | Schwarz-Gold · black-gold



PENDELLEUCHTE · PENDANT
excl. 1 x E27, max. 25 W

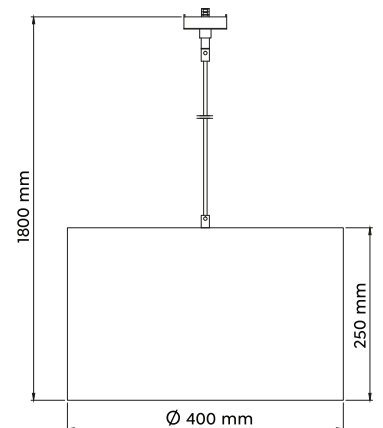

73820180 | Schwarz-Gold · black-gold





570 - 587

Einbauleuchten

Recessed lights

Spots encastrés

Inbouwspots

Focos empotrables

Faretti incasso

Spoturi incastrate

Upotetut spotit

Oprawy wbudowane

PAMIR

Metall · metal ·
metale · metaal · metal · metallo · metal · metalli · metal ·



06



07



31



32

Einbauleuchte · Recessed light
↔ 8,5 x 8,5 cm, ↑ 5,4 cm
incl. 1 x SMD, 5,5 W
345 lm, 3.000 K



650410106 | Chrom · chrome
650410107 | Nickel matt · nickel mat
650410131 | Weiß matt · white mat
650410132 | Schwarz matt · black mat

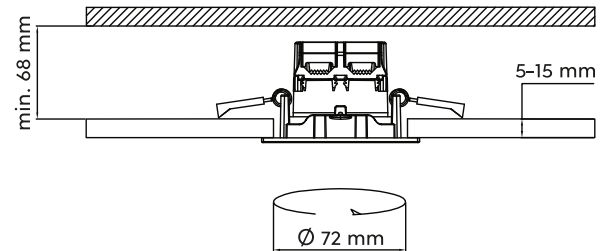

06



07



31



32

Einbauleuchte · Recessed light
Ø 8,5 cm, ↑ 5,4 cm
incl. 1 x SMD, 5,5 W
345 lm, 3.000 K



650510106 | Chrom · chrome
650510107 | Nickel matt · nickel mat
650510131 | Weiß matt · white mat
650510132 | Schwarz matt · black mat

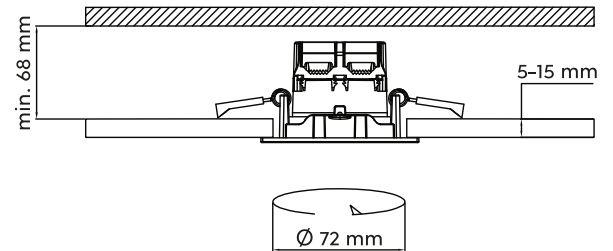

06



07

3er Set / Set 3

650410306 | Chrom · chrome
650410307 | Nickel matt · nickel mat
650410331 | Weiß matt · white mat

3er Set / Set 3

650510306 | Chrom · chrome
650510307 | Nickel matt · nickel mat
650510331 | Weiß matt · white mat

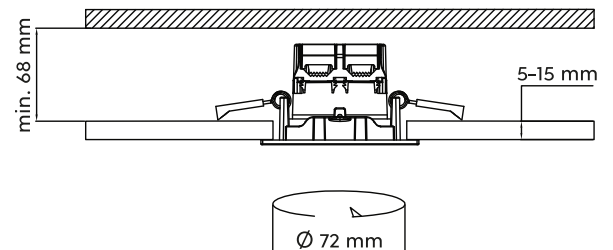



ZAGROS

Metall · metal ·
metale · metaal · metal · metallo · metal · metalli · metal ·



06



07



31



32

Einbauleuchte · Recessed light

↔ 8,5 x 8,5 cm, ↑ 5,4 cm
incl. 1 x SMD, 5,5 W
345 lm, 3.000 K



650610106 | Chrom · chrome
650610107 | Nickel matt · nickel mat
650610131 | Weiß matt · white mat
650610132 | Schwarz matt · black mat

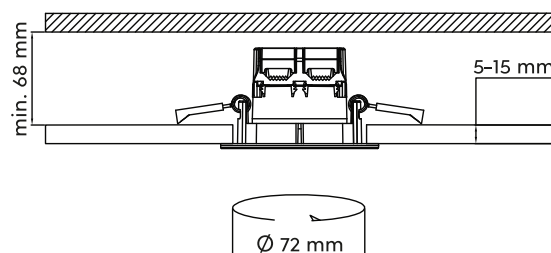

06



07



31



32

Einbauleuchte · Recessed light

Ø 8,5 cm, ↑ 5,4 cm
incl. 1 x SMD, 5,5 W
345 lm, 3.000 K



650710106 | Chrom · chrome
650710107 | Nickel matt · nickel mat
650710131 | Weiß matt · white mat
650710132 | Schwarz matt · black mat

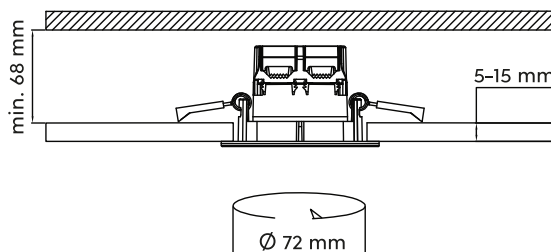

07



06

3er Set / Set 3

650610306 | Chrom · chrome
650610307 | Nickel matt · nickel mat
650610331 | Weiß matt · white mat

3er Set / Set 3

650710306 | Chrom · chrome
650710307 | Nickel matt · nickel mat
650710331 | Weiß matt · white mat

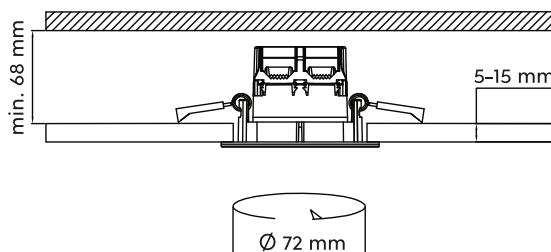



RILA

Metall · metal ·
metale · metaal · metal · metallo · metal · metalli · metal ·



06



07



31

Einbauleuchte · Recessed light

↔ 8 x 8 cm, ↑ 3,4 cm
incl. 1 x SMD, 5 W
370 lm, 3.000 K

650210106 | Chrom · chrome

650210107 | Nickel matt · nickel mat

650210131 | Weiß matt · white mat

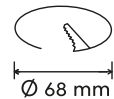
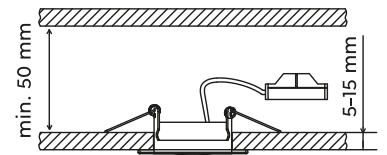

06



07



31

Einbauleuchte · Recessed light

Ø 8,2 cm, ↑ 3,4 cm
incl. 1 x SMD, 5 W
370 lm, 3.000 K

650310106 | Chrom · chrome

650310107 | Nickel matt · nickel mat

650310131 | Weiß matt · white mat

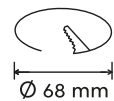
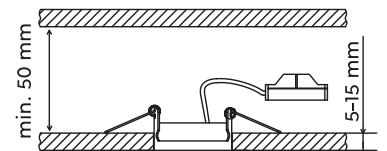

07



31

3er Set / Set 3

650210306 | Chrom · chrome

650210307 | Nickel matt · nickel mat

650210331 | Weiß matt · white mat

3er Set / Set 3

650310306 | Chrom · chrome

650310307 | Nickel matt · nickel mat

650310331 | Weiß matt · white mat

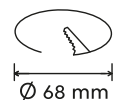
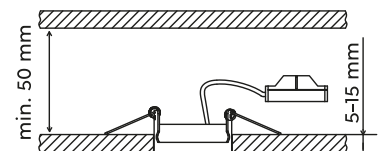



CORE

Kunststoff, Chrom, Weiß matt oder Schwarz matt · plastic, chrome, white mat or black mat ·
 plastique, chrome, blanc mat ou noir mat · kunststof, chrom, wit mat of mat zwart · plástico, cromo, estera blanca o estera negra ·
 plastica, cromo, bianco opaco o nero opaco · plastik, crom, alb mat sau negru mat · muovi, kromi, mattavalkoinen tai mattamusta ·
 plastik, chrom, biały mat lub czarny mat



06



31



32

Einbauleuchte · Recessed light
 Ø 8,2 cm, ↑ 3,5 cm
 incl. 1 x SMD, 5 W
 450 lm, 3.000 K

652510106 | Chrom · chrome
 652510131 | Weiß matt · white mat
 652510132 | Schwarz matt · black mat

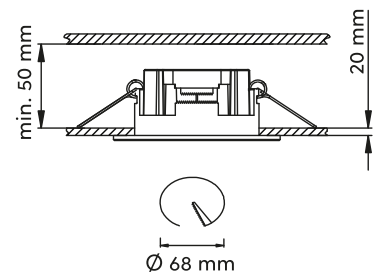

06



31



32

Einbauleuchte · Recessed light
 Ø 14,8 cm, ↑ 3,3 cm
 incl. 1 x SMD, 10 W
 1.040 lm, 3.000 K

652610106 | Chrom · chrome
 652610131 | Weiß matt · white mat
 652610132 | Schwarz matt · black mat

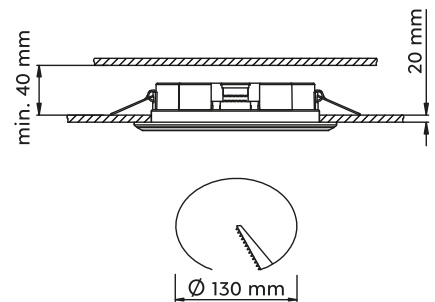

578



1x

2x

3x



Getrennt schaltbar · Separately switchable
 Interrupteurs séparés · Gescheiden schakelbaar ·
 Interruptores separados · Interruttori separati ·
 Intreruptoare separate · Erikseen kytkettäissä ·
 Oddzileny przełącznik



AURA

Kunststoff, Chrom, Weiß matt oder Schwarz matt · plastic, chrome, white mat or black mat ·
 plastique, chrome, blanc mat ou noir mat · kunststof, chrom, wit mat of mat zwart · plástico, cromo, estera blanca o estera negra ·
 plastica, cromo, bianco opaco o nero opaco · plastik, crom, alb mat sau negru mat · muovi, kromi, mattavalkoinen tai mattamusta ·
 plastik, chrom, biały mat lub czarny mat



06



31



32

Einbauleuchte · Recessed light

Ø 8,2 cm, ↓ 4 cm
 incl. 1 x SMD, 5 W
 450 lm, 3.000 K

652310106 | Chrom · chrome

652310131 | Weiß matt · white mat

652310132 | Schwarz matt · black mat



IP20

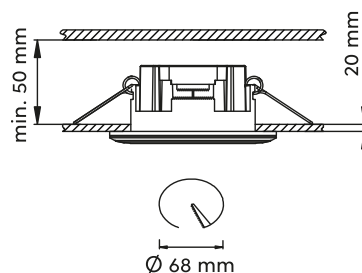

06



31



32

Einbauleuchte · Recessed light

Ø 14,8 cm, ↓ 3,8 cm
 incl. 1 x SMD, 10 W
 1.040 lm, 3.000 K

652410106 | Chrom · chrome

652410131 | Weiß matt · white mat

652410132 | Schwarz matt · black mat



IP20

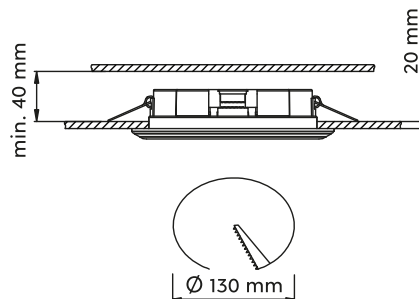

1x

2x

3x



Getrennt schaltbar · Separately switchable
 Interrupteurs séparés · Gescheiden schakelbaar ·
 Interruptores separados · Interruttori separati ·
 Intreruptoare separate · Erikseen kytkettävisä ·
 Oddzileny przełącznik



DOLOMITE

Kristallglas · crystal glass ·
verre cristal · kristal glas · vidrio cristal ·
vetro cristallo · sticla cristal · kristallilasi · szkło kryształ



Einbauleuchte · Recessed light

Ø 9 cm, ↑ 9,5 cm
excl. 1 x GU10, max. 10 W



651700152

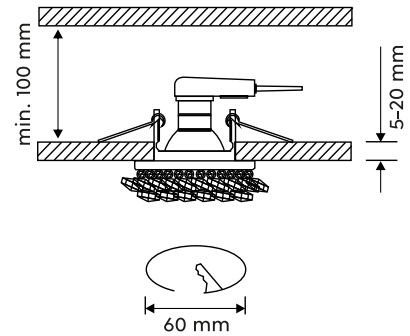

Einbauleuchte · Recessed light

↔ 10 x 10 cm, ↑ 9,5 cm
excl. 1 x GU10, max. 10 W



651800152

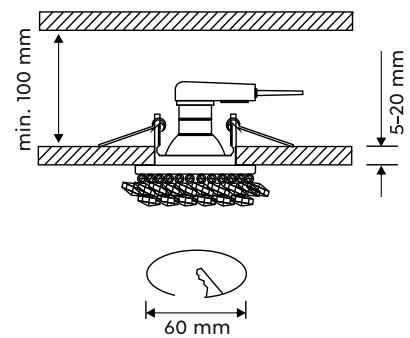

PIRIN

Kristallglas · crystal glass ·
verre cristal · kristal glas · vidrio cristal ·
vetro cristallo · sticla cristal · kristallilasi · szkło kryształ

582



Einbauleuchte · Recessed light

Ø 9 cm, ↑ 7 cm
excl. 1 x GU10, max. 10 W



652100152

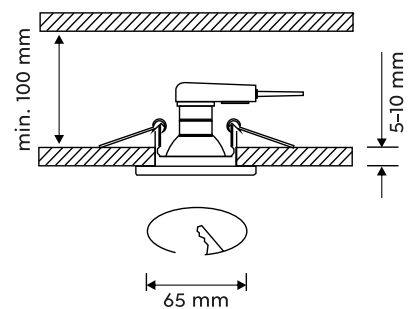

Einbauleuchte · Recessed light

↔ 9 x 9 cm, ↑ 7 cm
excl. 1 x GU10, max. 10 W



652200152

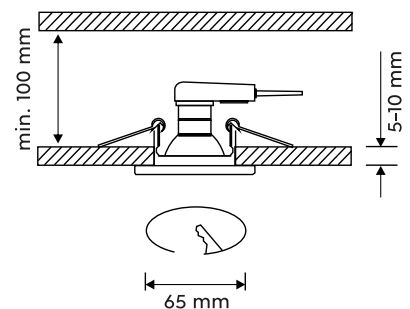



JURA

Metall · metal ·
metale · metaal · metal · metallo · metal · metalli · metal ·



06



07



08



31



32

Einbauleuchte · Recessed light

↔ 8 x 8 cm, ↑ 7 cm
excl. 1 x GU10, max. 15 W



- 650000106 | Chrom · chrome
- 650000107 | Nickel matt · nickel mat
- 650000108 | Messing matt · brass mat
- 650000131 | Weiß matt · white mat
- 650000132 | Schwarz matt · black mat

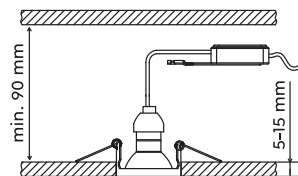

06



07



08



31



32

Einbauleuchte · Recessed light

Ø 8,3 cm, ↑ 7 cm
excl. 1 x GU10, max. 15 W



- 650100106 | Chrom · chrome
- 650100107 | Nickel matt · nickel mat
- 650100108 | Messing matt · brass mat
- 650100131 | Weiß matt · white mat
- 650100132 | Schwarz matt · black mat

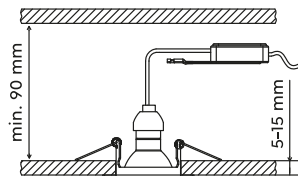

31



07

3er Set / Set 3

- 650000306 | Chrom · chrome
- 650000307 | Nickel matt · nickel mat
- 650000331 | Weiß matt · white mat

3er Set / Set 3

- 650100306 | Chrom · chrome
- 650100307 | Nickel matt · nickel mat
- 650100331 | Weiß matt · white mat



KENAI

Metall · metal ·
metale · metaal · metal · metallo · metal · metalli · metal ·



31



32

Einbauleuchte · Recessed light
Ø 9,2 cm, ↑ 10 cm
excl. 1 x GU10, max. 15 W

651500131 | Weiß matt · white mat
651500132 | Schwarz matt · black mat

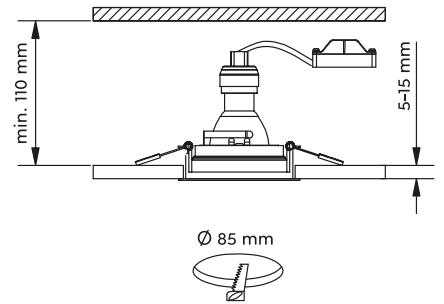

31



32

Einbauleuchte · Recessed light
↔ 9,2 x 9,2 cm, ↑ 10 cm
excl. 1 x GU10, max. 15 W

651600131 | Weiß matt · white mat
651600132 | Schwarz matt · black mat

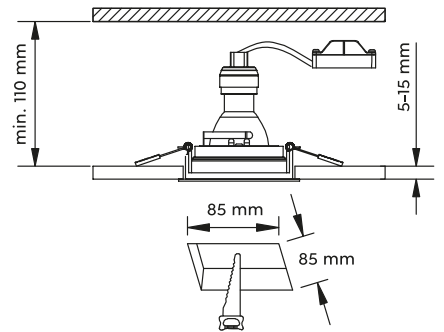

31



32

Einbauleuchte · Recessed light
↔ 17,2 x 9,2 cm, ↑ 10 cm
excl. 2 x GU10, max. 15 W

651600231 | Weiß matt · white mat
651600232 | Schwarz matt · black mat

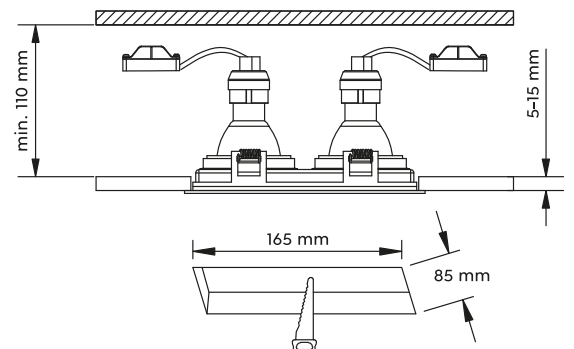



31



32

Einbauleuchte · Recessed light
 ↔ 25,2 x 9,2 cm, ↑ 10 cm
 excl. 3 x GU10, max. 15 W



651600331 | Weiß matt · white mat
 651600332 | Schwarz matt · black mat

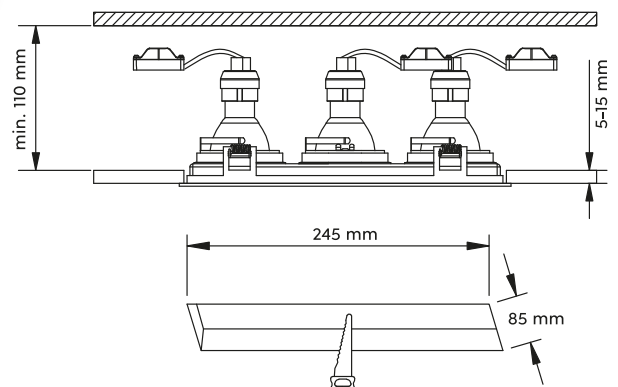





588 - 621

Badezimmerleuchten

Bathroom lighting
Éclairage salle de bains
Badkamer verlichting
Iluminación de cuarto de baño
Illuminazione per bagno
Illuminat baie
Kylpyhuone valaistus
Oświetlenie łazienkowe

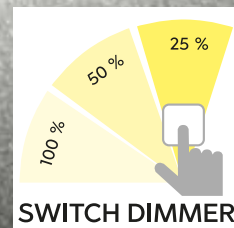

ASCARI

Metall, Chrom oder Schwarz matt · metal, chrome or black mat ·
 metale, chrome ou noir mat · metaal, chroom of mat zwart · metal, cromo o estera negra ·
 metallo, cromo o nero opaco · metal, crom sau negru mat · metalli, kromi tai mattamusta ·
 metal, chrom lub czarny mat

IP44



06 | Chrom · chrome



32 | Schwarz matt · black mat



Deckenleuchte · Ceiling lamp
 Ø 30 cm, ↑ 6,8 cm
 incl. SMD-LED, 28 W
 3.200 lm, 3.000 K



680810306
 680810332



Deckenleuchte · Ceiling lamp
 Ø 40 cm, ↑ 6,8 cm
 incl. SMD-LED, 35 W
 4.100 lm, 3.000 K



680819306
 680819332



GIANNI

Metall, Chrom oder Schwarz matt · metal, chrome or black mat ·
 metale, chrome ou noir mat · metaal, chroom of mat zwart · metal, cromo o estera negra ·
 metallo, cromo o nero opaco · metal, crom sau negru mat · metalli, kromi tai mattamusta ·
 metal, chrom lub czarny mat



IP44



Wandleuchte · Wall lamp
 ↔ 40 x 17,5 cm, ∇ 14,8 cm
 incl. SMD-LED, 17 W
 1.700 lm, 3.000 K

Wandleuchte · Wall lamp
 ↔ 60 x 8 cm, ∇ 15 cm
 incl. SMD-LED, 22 W
 2.700 lm, 3.000 K



283770106
 283770132



283779106
 283779132



06 | Chrom · chrome



32 | Schwarz matt · black mat



Deckenleuchte · Ceiling lamp
Ø 41,5 cm, ↑ 16,5 cm
incl. 5 x SMD-LED, 3,1 W
5 x 310 lm, 3.000 K

IP44



682410506



BOLSA

Chrom, Acryl · chrome, acryl ·
chrome, acryl · chroom, acryl · cromo, acrílico ·
cromo, acrílico · crom, acrilic · kromi, akryyli ·
chrom, akryl

IP44



592



Wandleuchte · Wall lamp
↑ 19 cm, ↔ 7 cm, √ 12 cm
incl. 1 x SMD-LED, 3,1 W
310 lm, 3.000 K

IP44



282410106



Wandleuchte · Wall lamp
↑ 30 cm, ↔ 7 cm, √ 12 cm
incl. 2 x SMD-LED, 3,2 W
2 x 300 lm, 3.000 K

IP44



282410206

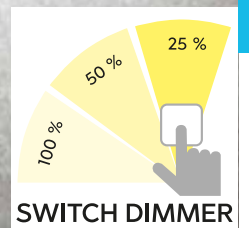

CINZIA

Chrom, Acryl mit Kristalleffekt · chrome, broken glass optic ·
 chrome, optique verre pilé · chroom, Gebroken glas optiek ·
 cromo, Efecto cristal roto · cromo, effetto ottico vetro rotto ·
 crom, aspect de sticla sparta · kromi, lasi efekti optiikka ·
 chrom, Optyczne rozbite szkło

IP44



Deckenleuchte · Ceiling lamp
 Ø 40 cm, ↑ 3 cm
 incl. SMD-LED, 20 W
 2.250 lm, 3.000 K



IP44

686412406



Deckenleuchte · Ceiling lamp
 ↔ 40 x 40 cm, ↑ 3 cm
 incl. SMD-LED, 20 W
 2.250 lm, 3.000 K



IP44

686512406



CLARIMO

Kunststoff · plastic ·
plastique · kunststof · plástico · plastica · plastic · muovi · plastik



IP44

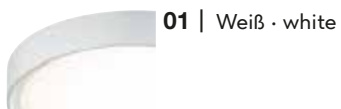

01 | Weiß · white

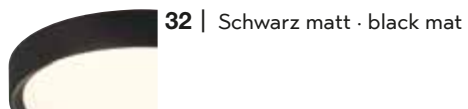

32 | Schwarz matt · black mat



06 | Chrom · chrome



87 | titanfarbig · titanium-coloured

Deckenleuchte · Ceiling lamp
Ø 33 cm, ↓ 9 cm,
incl. SMD-LED, 18 W
1.600 lm, 3.000 K

IP44

659011801
659011806
659011832
659011887



RAY

Kunststoff, Chrom oder Schwarz matt · plastic, chrome or black mat ·
 plastique, chrome ou noir mat · kunststof, chroom of mat zwart ·
 plástico, cromo o estera negra · plastica, cromo o nero opaco ·
 plastic, crom sau negru mat · muovi, kromi tai mattamusta ·
 plastik, chrom lub czarny mat

IP44

06 | Chrom · chrome

32 | Schwarz matt · black mat



Wandleuchte · Wall lamp
 ↑ 8,3 x 5,2 cm, √ 8 cm
 incl. 1 x SMD-LED, 4 W
 340 lm, 3.000 K

IP44

283110106
 283110132



Wandleuchte · Wall lamp
 ↑ 16,6 x 5,2 cm, √ 8 cm
 incl. 2 x SMD-LED, 4 W
 2 x 340 lm, 3.000 K

IP44



283110206
 283110232



ROCCO

Metall, Chrom oder Schwarz matt · metal, chrome or black mat ·
 metale, chrome ou noir mat · metaal, chroom of mat zwart · metal, cromo o estera negra ·
 metallo, cromo o nero opaco · metal, crom sau negru mat · metalli, kromi tai mattamusta ·
 metal, chrom lub czarny mat



IP44



06 | Chrom · chrome



32 | Schwarz matt · black mat

Wandleuchte · Wall lamp
 ↔ 60 x 3,6 cm, ↗ 8 cm
 incl. SMD-LED, 8 W
 800 lm, 3.000 K



283916006
283916032

Wandleuchte · Wall lamp
 ↔ 90 x 3,6 cm, ↗ 8 cm
 incl. SMD-LED, 13 W
 1.400 lm, 3.000 K



283919006
283919032





Wandleuchte · Wall lamp
 ↔ 41,5 x 5,5 cm, ∅ 7 cm
 incl. SMD-LED, 8 W
 850 lm, 3.000 K



284074206
284074232



Wandleuchte · Wall lamp
 ↔ 79 x 5,5 cm, ∅ 7 cm
 incl. SMD-LED, 16 W
 1.650 lm, 3.000 K



284077906
284077932



Wandleuchte · Wall lamp
 ↔ 119 x 5,5 cm, ∅ 7 cm
 incl. SMD-LED, 21 W
 2.200 lm, 3.000 K



284071206
284071232



PIERA



Kunststoff, Chrom oder Schwarz matt · plastic, chrome or black mat ·
 plastique, chrome ou noir mat · kunststof, chrom of mat zwart · plástico, cromo o estera negra ·
 plastica, cromo o nero opaco · plastic, crom sau negru mat · muovi, kromi tai mattamusta ·
 plastik, chrom lub czarny mat

IP44

06 | Chrom · chrome



32 | Schwarz matt · black mat

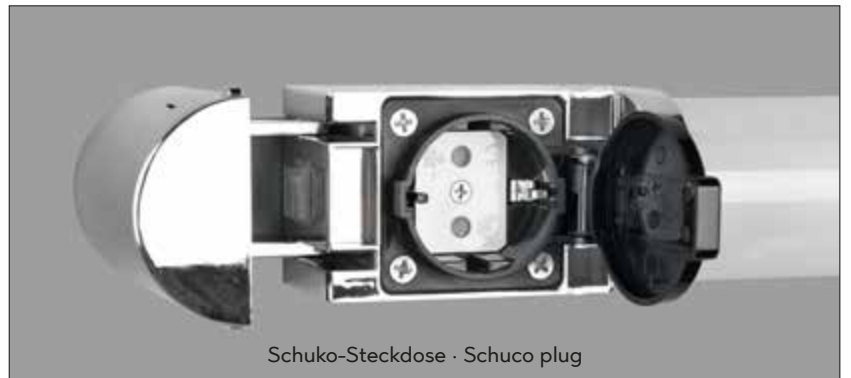

FABIO



Metall, Chrom oder Schwarz matt · metal, chrome or black mat ·
 metale, chrome ou noir mat · metaal, chroom of mat zwart · metal, cromo o estera negra ·
 metallo, cromo o nero opaco · metal, crom sau negru mat · metalli, kromi tai mattamusta ·
 metal, chrom lub czarny mat

IP44



01 | Weiß · white



02 | Schwarz · black



Wandleuchte · Wall lamp
 ↔ 42,5 x 3,8 cm, ∠ 7,9 cm
 incl. SMD-LED, 6 W
 700 lm, 3.000 K

IP44

283814206
 283814232



Wandleuchte · Wall lamp
 ↔ 80 x 3,8 cm, ∠ 7,9 cm
 incl. SMD-LED, 12 W
 1.400 lm, 3.000 K

IP44

283817906
 283817932



Wandleuchte · Wall lamp
 ↔ 120 x 3,8 cm, ∠ 7,9 cm
 incl. SMD-LED, 20 W
 2.300 lm, 3.000 K

IP44

283811206
 283811232

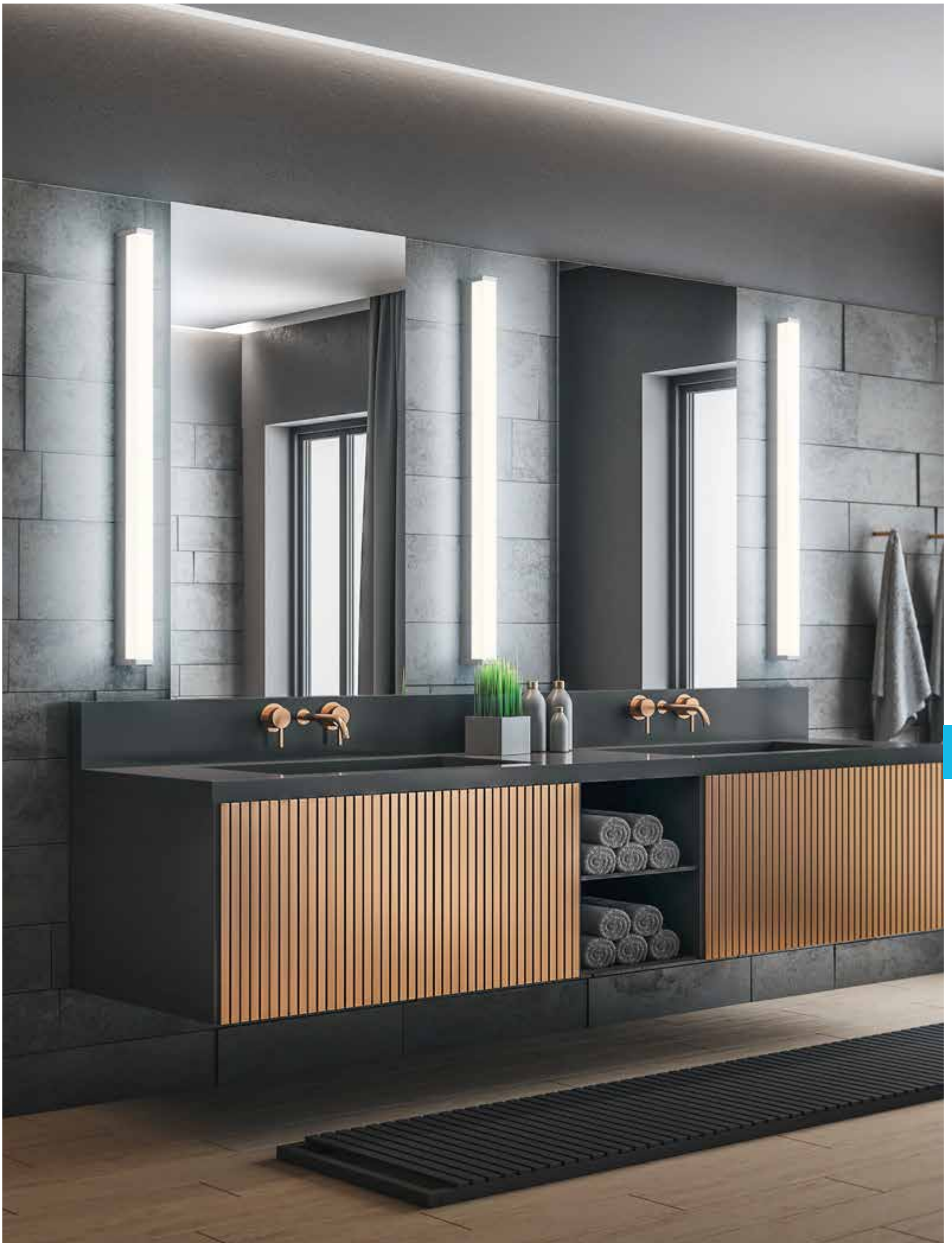

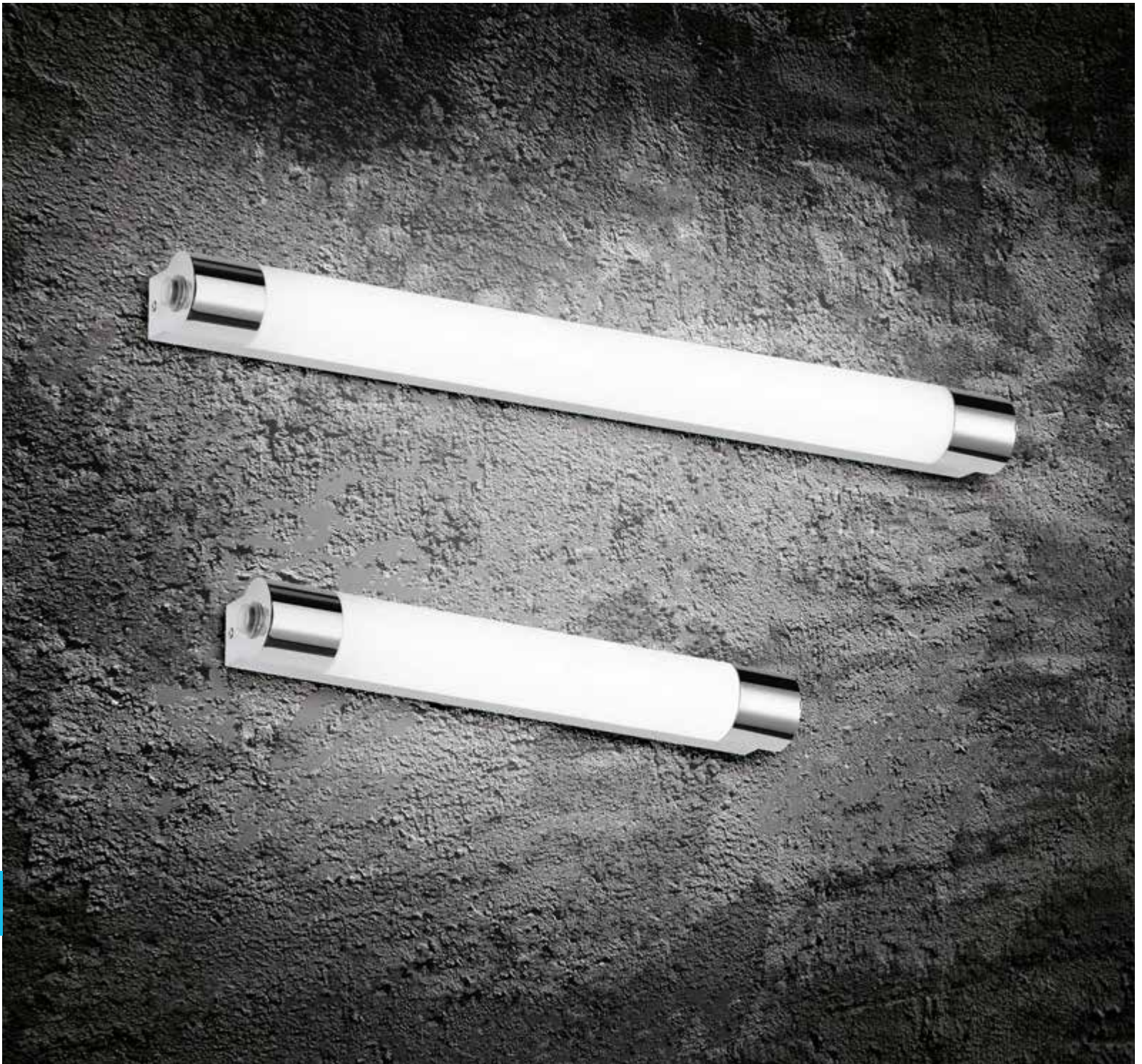

KOLIAN

Kunststoff, Chrom · plastic, chrome ·
 plastique, chrome · kunststof, chrom · plástico, cromo · plastica, cromo · plastic, crom · muovi, kromi · plastik, chrom



IP44



Steckdose ·
 Plug



Schuko-Steckdose ·
 Schuco plug



Wandleuchte · Wall lamp
 ↔ 44 x 6 cm, ∇ 9 cm
 incl. SMD-LED, 6 W
 600 lm, 3.000 K



281570606



Wandleuchte · Wall lamp
 ↔ 64 x 6 cm, ∇ 9 cm
 incl. SMD-LED, 9 W
 970 lm, 3.000 K



281570906

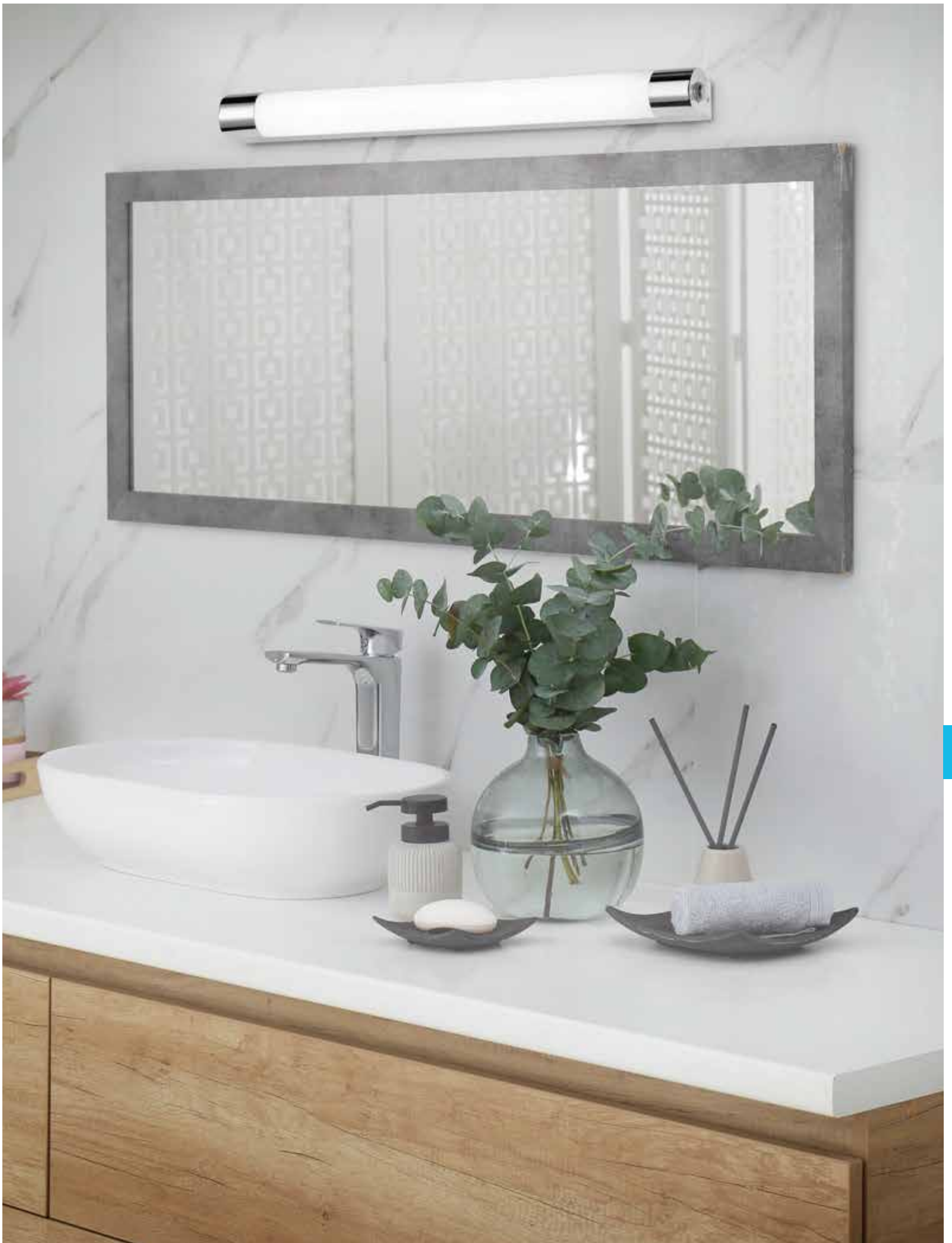



Wandleuchte · Wall lamp
 ↔ 40,4 x 5,5 cm, ↗ 8,5 cm
 incl. 1 x SMD-LED, 4,3 W
 450 lm, 3.000 K



283270106
283270132



Wandleuchte · Wall lamp
 ↔ 60,4 x 5,5 cm, ↗ 8,8 cm
 incl. 1 x SMD-LED, 6,5 W
 680 lm, 3.000 K



283270206
283270232



Wandleuchte · Wall lamp
 ↔ 80,4 x 5,5 cm, ↗ 8,8 cm
 incl. 1 x SMD-LED, 8,6 W
 880 lm, 3.000 K



283270306
283270332



MATTIMO



Metall, Kunststoff, Chrom oder Schwarz matt · metal, plastic, chrome or black mat ·
 metale, plastique, chrome ou noir mat · metaal, kunststof, chroom of mat zwart · metal, plástico, cromo o estera negra ·
 metallo, plastica, cromo o nero opaco · metal, plastic, crom sau negru mat · metalli, muovi, kromi tai mattamusta ·
 metal, plastik, chrom lub czarny mat

IP44



06 | Chrom · chrome



32 | Schwarz matt · black mat





VIEW

Chrom · chrome ·
chrome · chroom · cromo · cromo ·
crom · kromi · chrom

IP44



On/Off Touch Funktion ·
On/Off Touch function



Vergrößerung 3x ·
Magnification 3x



Wandleuchte · Wall lamp
Ø 21 cm, \sphericalangle max. 36 cm
incl. SMD-LED, 3 W
280 lm, 3.000 K



282990106



THEATRO

Chrom · chrome ·
chrome · chroom · cromo · cromo ·
crom · kromi · chrom

IP44



Empfohlen:
recommended: Filament LED E27, 4 W
420 lm, 2.800 K



987-410

Wandleuchte · Wall lamp
↔ 55 x 8 cm, ∅ 6,5 cm
excl. 4 x E27, max. 28 W



283600406



LINO



Kunststoff, Chrom oder Schwarz matt · plastic, chrome or black mat ·
 plastique, chrome ou noir mat · kunststof, chroom of mat zwart · plástico, cromo o estera negra ·
 plastica, cromo o nero opaco · plastic, crom sau negru mat · muovi, kromi tai mattamusta ·
 plastik, chrom lub czarny mat

IP44



06 | Chrom · chrome



32 | Schwarz matt · black mat



Wandleuchte · Wall lamp
 ↔ 40 x 6 cm, ∅ 10,5 cm
 incl. SMD-LED, 7,5 W
 800 lm, 3.000 K

IP44

284114006
 284114032



Wandleuchte · Wall lamp
 ↔ 60 x 6 cm, ∅ 10,5 cm
 incl. SMD-LED, 11,5 W
 1.200 lm, 3.000 K

IP44

284116006
 284116032





LORENZO

Metall, Chrom oder Schwarz matt · metal, chrome or black mat ·
 metale, chrome ou noir mat · metaal, chroom of mat zwart · metal, cromo o estera negra ·
 metallo, cromo o nero opaco · metal, crom sau negru mat · metalli, kromi tai mattamusta ·
 metal, chrom lub czarny mat

IP44

Empfohlen:
 recommended: LED GU10, 3 W
 250 lm, 3.000 K



956-30



06 | Chrom · chrome



32 | Schwarz matt · black mat

Strahler · Spot
 ↓ 5,4 x 3,3 cm, ↗ 10,1 cm
 excl. 1 x GU10, max. 5 W



IP44

283500106
 283500132



GIADA



Metall, Chrom oder Schwarz matt · metal, chrome or black mat ·
 metale, chrome ou noir mat · metaal, chroom of mat zwart · metal, cromo o estera negra ·
 metallo, cromo o nero opaco · metal, crom sau negru mat · metalli, kromi tai mattamusta ·
 metal, chrom lub czarny mat

IP44

Empfohlen:
 recommended: LED GU10, 3 W
 250 lm, 3.000 K



956-30



06 | Chrom · chrome



32 | Schwarz matt · black mat

Strahler · Spot
 ↓ 11,4 x 5,4 cm, ∅ 34,3 cm
 excl. 1 x GU10, max. 5 W



283400106
 283400132



Strahler · Spot
 Ø 10,5 cm cm, ↗ 15,5 cm
 excl. 1 x GU10, max. 5 W



880400106
 880400132



Strahler · Spot
 Ø 20 cm, ↑ 15,5 cm
 excl. 3 x GU10, max. 5 W



880430306
 880430332



Strahler · Spot
 ↔ 52 x 9,5 cm, ↑ 19,5 cm
 excl. 4 x GU10, max. 5 W



880400406
 880400432



613

ANGELO



Metall, Chrom oder Schwarz matt · metal, chrome or black mat ·
 metale, chrome ou noir mat · metaal, chroom of mat zwart · metal, cromo o estera negra ·
 metallo, cromo o nero opaco · metal, crom sau negru mat · metalli, kromi tai mattamusta · metal, chrom lub czarny mat

IP44



06 | Chrom · chrome

Empfohlen:
 recommended: LED GU10, 3 W
 250 lm, 3.000 K



956-30



32 | Schwarz matt · black mat



PAOLO

Kunststoff, Weiß · plastic, white ·
 plastique, blanc · kunststof, wit · plástico, blanco ·
 plastica, bianco · plastic, alb · muovi, valkoinen · plastik, biały

IP44



Deckenleuchte · Ceiling lamp
 Ø 37 cm, ↑ 8,5 cm
 incl. SMD-LED, 15 W
 1.500 lm, 3.000 K

IP44

686014001



Deckenleuchte · Ceiling lamp
 Ø 37 cm, ↑ 8,5 cm
 incl. SMD-LED, 15 W
 1.500 lm, 4.000 K



IP44

686014000



FRODENO

Acryl · acryl · acryl · acryl · acrílico · acrílico · acrílic · akryyli · akryl



RGBW Farbwechsler · RGBW Colorchanging



Memory Funktion · Memory function



Starlight Effekt · Starlight effect



Deckenleuchte · Ceiling lamp
 Ø 35 cm, ↑ 8,7 cm
 incl. RGBW-LED, 12 W
 1.200 lm, 4.000 K



680213500

Deckenleuchte · Ceiling lamp
 Ø 48 cm, ↑ 10,2 cm
 incl. RGBW-LED, 18,5 W
 1.900 lm, 4.000 K



680214800



APART

Kunststoff, Chrom · plastic, chrome ·
 plastique, chrome · kunststof, chroom · plástico, cromo ·
 plastica, cromo · plastic, crom · muovi, kromi · plastik, chrom

IP44



Deckenleuchte · Ceiling lamp
 Ø 35 cm, ↑ 10 cm,
 incl. SMD-LED, 18 W
 1.600 lm, 3.000 K

IP44

659411806



Deckenleuchte · Ceiling lamp
 Ø 41 cm, ↑ 10 cm,
 incl. SMD-LED, 24 W
 2.100 lm, 3.000 K

IP44

659412406



UMBERTO



Kunststoff, Chrom oder Schwarz matt · plastic, chrome or black mat ·
 plastique, chrome ou noir mat · kunststof, chrom of mat zwart · plástico, cromo o estera negra ·
 plastica, cromo o nero opaco · plastic, crom sau negru mat · muovi, kromi tai mattamusta ·
 plastik, chrom lub czarny mat

IP44



06 | Chrom · chrome



32 | Schwarz matt · black mat



Deckenleuchte · Ceiling lamp
 Ø 29 cm, ↑ 8 cm
 incl. SMD-LED, 12 W
 1.160 lm, 3.000 K

IP44

680310106
680310132



Deckenleuchte · Ceiling lamp
 Ø 42 cm, ↑ 10 cm
 incl. SMD-LED, 18,5 W
 1.900 lm, 3.000 K

IP44

680319106
680319132

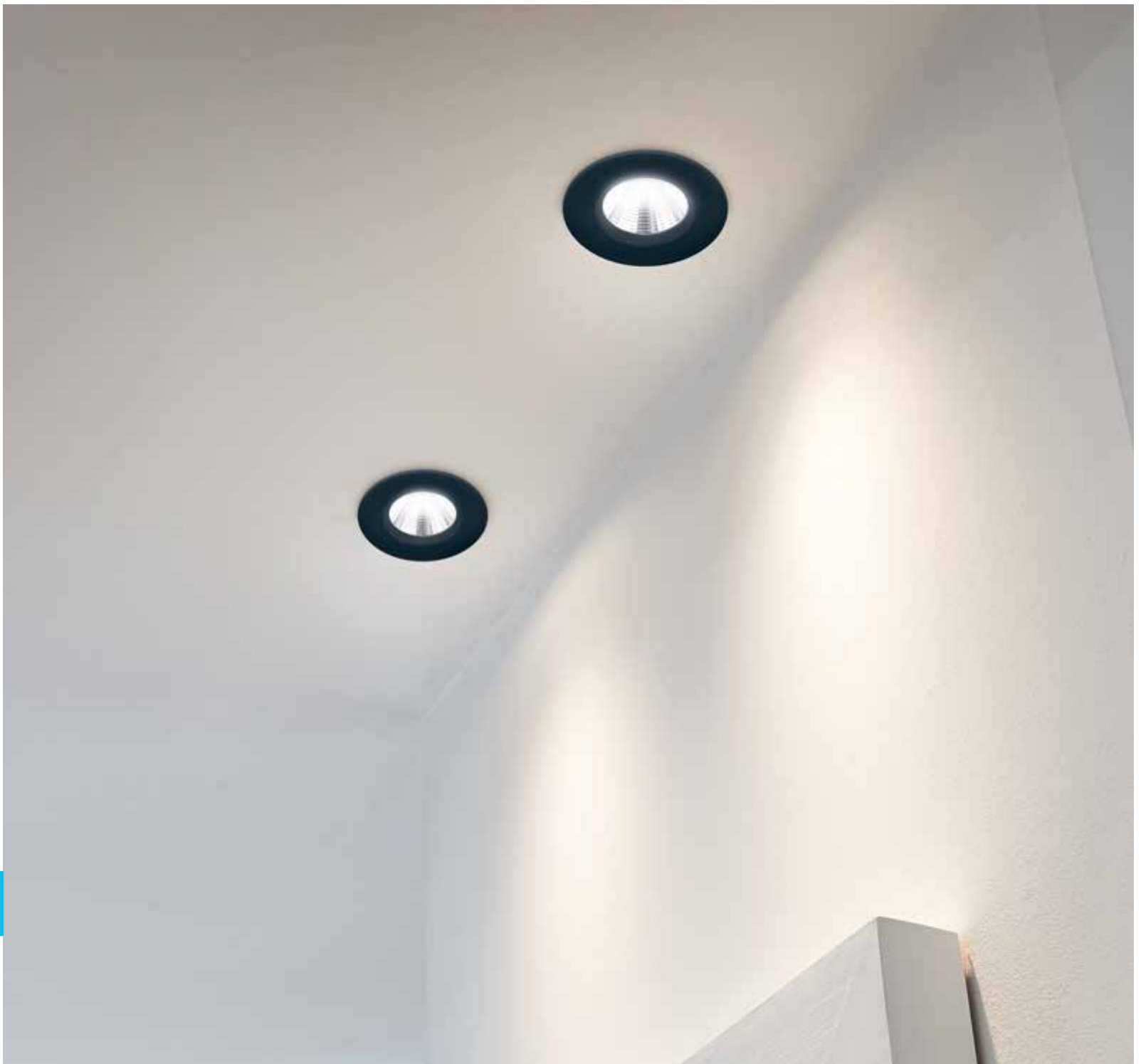

ZENIA

Metall · metal ·
metale · metaal · metal · metallo · metal · metalli · metal

IP65

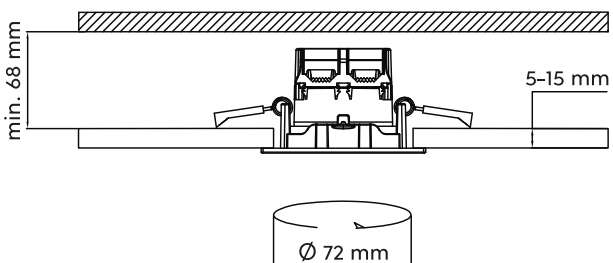

06 | Chrom · chrome



31 | Weiß matt · white mat



32 | Schwarz matt · black mat

Einbauleuchte · Recessed spot
Ø 8,5 cm, ↑ 5,4 cm
incl. SMD-LED, 5,5 W
345 lm, 3.000 K



IP65

680710106
680710131
680710132



CAMILLA

Kunststoff, Schwarz matt · plastic, black mat ·
 plastique, noir mat · kunststof, mat zwart · plástico, estera negra ·
 plastica, nero opaco · plastic, negru mat · muovi, mattamusta · plastik, czarny mat



IP44

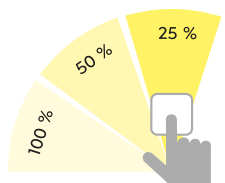

SWITCH DIMMER



Deckenleuchte · Ceiling lamp
 Ø 40 cm, ↑ 3 cm
 incl. SMD-LED, 20 W
 2.250 lm, 3.000 K



IP44

689214032



Deckenleuchte · Ceiling lamp
 ↔ 40 x 40 cm, ↑ 3 cm
 incl. SMD-LED, 20 W
 2.250 lm, 3.000 K



IP44

689314032



XAVI

Chrom, Glas matt · chrome, mat glass ·
 chrome, verre mat · chroom, mat glas · cromo, vidrio mate ·
 cromo, vetro sabbato · crom, sticla mata · kromi, mattalasi ·
 chrom, szkło matowane

IP21



Wandleuchte · Wall lamp
 ↔ 30,5 cm, ↑ 8,3 cm, ∠ 6,3 cm
 excl. 2 x E14, max. 40 W



IP21

2803021-06



Wandleuchte · Wall lamp
 ↔ 40,5 cm, ↑ 8,3 cm, ∠ 6,3 cm
 excl. 3 x E14, max. 40 W



IP21

2803031-06



CONDUS

Metall, Glas matt · metal, mat glass ·
 metale, verre mat · metaal, mat glas · metal, vidrio mate ·
 metallo, vetro sabbiato · metal, sticla mata · metalli, mattalasi ·
 metal, szkło matowane



IP44



01 | Weiß · white



07 | Nickel matt · nickel mat



06 | Chrom · chrome



32 | Schwarz matt · black matt

Deckenleuchte · Ceiling lamp

Ø 31,5 cm, ↑ 8 cm

excl. 1 x E27, max. 60 W



IP44

6801011-01

6801011-06

6801011-07

6801011-32





622 - 631

Leuchtmittel

Light sources

Ampoules

Lichtbronnen

Fuentes de luz

Lampadine

Becuri

Valonlähteet

Źródła światła

LED-LEUCHTMITTEL E27

LED bulbs E27 · Ampoules LED E27 · LED-lampen E27 · Bombillas a LED E27 ·
Lampadine a LED E27 · Becuri cu LED-uri E27 · LED-Valonl hteet E27 ·  ar wki LED E27

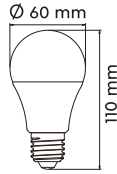

Code	Socket	Power	Lumen	Kelvin	Lifetime	Dimmable	Switch Dimmer	Switch Dim To Warm
987-60	E27	6 W	470 lm	3.000 K	25.000 h			
988-700	E27	7 W	560 lm	3.000 K	25.000 h	✓		
988-10	E27	10 W	806 lm	3.000 K	25.000 h		✓	
988-110	E27	10 W	806 lm	3.000 K	25.000 h	✓		

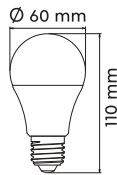

987-909	E27	9 W	806 lm	2.200 K 2.700 K 3.000 K	25.000 h			✓
---------	-----	-----	--------	-------------------------------	----------	--	--	---



Set 2

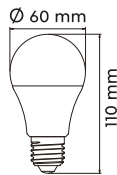

987-260	E27	6 W	320 lm	3.000 K	25.000 h			
---------	-----	-----	--------	---------	----------	--	--	--

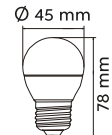

986-40	E27	4 W	320 lm	3.000 K	25.000 h			
986-60	E27	5 W	400 lm	3.000 K	25.000 h			



Set 3

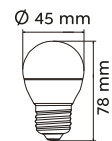

986-43	E27	4 W	320 lm	3.000 K	10.000 h			
986-63	E27	5 W	400 lm	3.000 K	10.000 h			

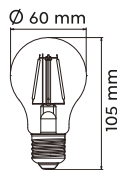

987-400	E27	4,5 W	470 lm	2.700 K	10.000 h			
987-6810	E27	7 W	806 lm	2.700 K	10.000 h		✓	

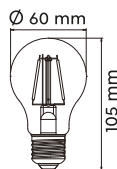

987-7009	E27	7 W	806 lm	2.200 K 2.700 K 3.000 K	10.000 h			✓
----------	-----	-----	--------	-------------------------------	----------	--	--	---



Set 2

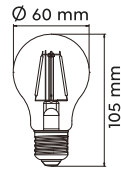

Code	Socket	Power	Lumen	Kelvin	Lifetime	Dimmable	Switch Dimmer	Switch Dim To Warm
987-2400	E27	4,5 W	470 lm	2.700 K	10.000 h			

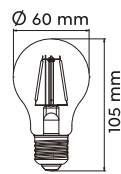

987-479 amber	E27	4 W	470 lm	2.700 K	10.000 h			
987-6700 amber	E27	8 W	700 lm	2.700 K	10.000 h		✓	



Set 2

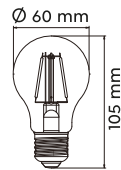

987-2479 amber	E27	4 W	470 lm	2.700 K	10.000 h			
----------------	-----	-----	--------	---------	----------	--	--	--

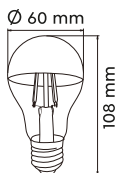

987-410 amber	E27	4 W	420 lm	2.800 K	10.000 h			
---------------	-----	-----	--------	---------	----------	--	--	--

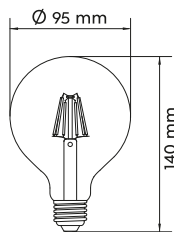

988-600	E27	6 W	600 lm	3.000 K	10.000 h			
---------	-----	-----	--------	---------	----------	--	--	--

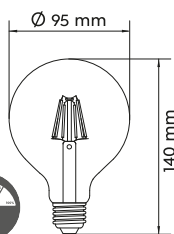

985-6810	E27	8 W	806 lm	2.700 K	10.000 h		✓	
----------	-----	-----	--------	---------	----------	--	---	--

LED-LEUCHTMITTEL E27

LED bulbs E27 · Ampoules LED E27 · LED-lampen E27 · Bombillas a LED E27 ·
Lampadine a LED E27 · Becuri cu LED-uri E27 · LED-Valonl hteet E27 ·  ar wki LED E27

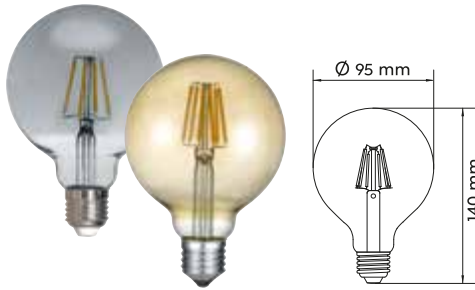

Code	Socket	Power	Lumen	Kelvin	Lifetime	Dimmable	Switch Dimmer	Switch Dim To Warm
988-654 smoke	E27	6 W	250 lm	3.000 K	10.000 h			
988-679 amber	E27	6 W	420 lm	2.700 K	10.000 h			

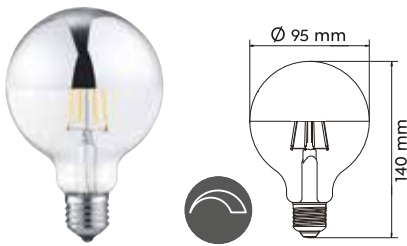

988-710	E27	7 W	680 lm	2.700 K	10.000 h	✓		
---------	-----	-----	--------	---------	----------	---	--	--



986-6810 clear	E27	8 W	810 lm	2.700 K	10.000 h		✓	
986-6790 amber	E27	8 W	810 lm	2.700 K	10.000 h		✓	



986-710	E27	7 W	680 lm	2.700 K	10.000 h	✓		
---------	-----	-----	--------	---------	----------	---	--	--



987-600 clear	E27	6 W	600 lm	3.000 K	10.000 h			
987-679 amber	E27	6 W	600 lm	2.700 K	10.000 h			

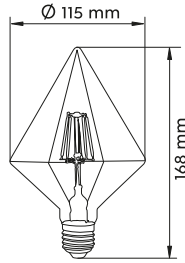

Code	Socket	Power	Lumen	Kelvin	Lifetime	Dimmable	Switch Dimmer	Switch Dim To Warm
------	--------	-------	-------	--------	----------	----------	---------------	--------------------

901-454	smoke	E27	4 W	140 lm	3.000 K	25.000 h		
901-479	amber	E27	4 W	320 lm	2.700 K	25.000 h		

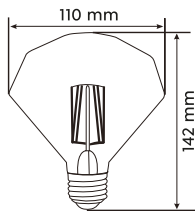

902-454	smoke	E27	4 W	140 lm	3.000 K	25.000 h		
902-479	amber	E27	4 W	320 lm	2.700 K	25.000 h		

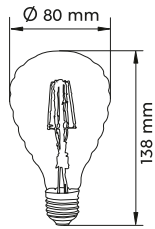

903-454	smoke	E27	4 W	140 lm	3.000 K	25.000 h		
903-479	amber	E27	4 W	320 lm	2.700 K	25.000 h		

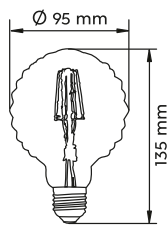

904-454	smoke	E27	4 W	140 lm	3.000 K	25.000 h		
904-479	amber	E27	4 W	320 lm	2.700 K	25.000 h		

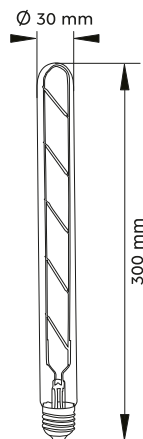

905-454	smoke	E27	4 W	100 lm	3.000 K	25.000 h		
905-479	amber	E27	4 W	320 lm	2.700 K	25.000 h		

LED-LEUCHTMITTEL E14

LED bulbs E14 · Ampoules LED E14 · LED-lampen E14 · Bombillas a LED E14 ·
Lampadine a LED E14 · Becuri cu LED-uri E14 · LED-Valonlähtet E14 · Żarówki LED E14

Code	Socket	Power	Lumen	Kelvin	Lifetime	Dimmable	Switch Dimmer	Switch Dim To Warm
------	--------	-------	-------	--------	----------	----------	---------------	--------------------

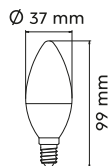

989-40	E14	4 W	320 lm	3.000 K	25.000 h			
989-56	E14	5 W	400 lm	3.000 K	25.000 h	✓		
989-60	E14	5 W	400 lm	3.000 K	25.000 h			
989-66	E14	6 W	470 lm	3.000 K	25.000 h		✓	

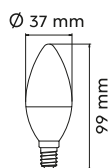

989-509	E14	5,5 W	400 lm	2.200 K	25.000 h			✓
				2.700 K				
				3.000 K				



Set 3

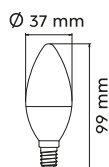

989-43	E14	4 W	320 lm	3.000 K	25.000 h			
989-63	E14	6 W	470 lm	3.000 K	25.000 h			

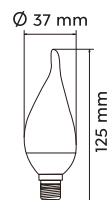

990-40	E14	4 W	320 lm	3.000 K	25.000 h			
--------	-----	-----	--------	---------	----------	--	--	--

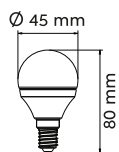

983-40	E14	4 W	320 lm	3.000 K	25.000 h			
983-56	E14	5 W	400 lm	3.000 K	25.000 h	✓		
983-60	E14	5 W	400 lm	3.000 K	25.000 h			
983-66	E14	6 W	470 lm	3.000 K	25.000 h		✓	

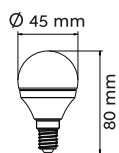

983-509	E14	5,5 W	400 lm	2.200 K	25.000 h			✓
				2.700 K				
				3.000 K				



Set 3

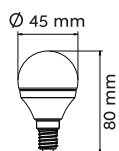

983-43	E14	4 W	320 lm	3.000 K	25.000 h			
983-63	E14	5 W	400 lm	3.000 K	25.000 h			

Code	Socket	Power	Lumen	Kelvin	Lifetime	Dimmable	Switch Dimmer	Switch Dim To Warm
------	--------	-------	-------	--------	----------	----------	---------------	--------------------

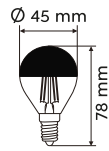

983-410	E14	4 W	420 lm	3.000 K	10.000 h			
---------	-----	-----	--------	---------	----------	--	--	--

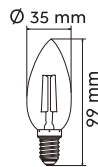

989-200	clear	E14	2 W	250 lm	2.700 K	10.000 h		
989-279	amber	E14	2 W	225 lm	2.700 K	10.000 h		
989-400	clear	E14	4,5 W	470 lm	2.700 K	10.000 h		
989-479	amber	E14	4 W	400 lm	2.700 K	10.000 h		

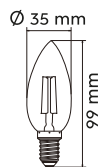

989-4470	clear	E14	4 W	470 lm	2.700 K	10.000 h		✓
989-4790	amber	E14	4 W	400 lm	2.700 K	10.000 h		✓



Set 3

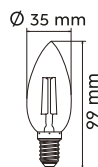

989-3200	clear	E14	2 W	250 lm	2.700 K	10.000 h		
989-3279	amber	E14	2 W	225 lm	2.700 K	10.000 h		

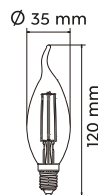

990-200	clear	E14	2 W	250 lm	2.700 K	10.000 h		
990-279	amber	E14	2 W	225 lm	2.700 K	10.000 h		
990-400	clear	E14	4 W	400 lm	3.000 K	10.000 h		

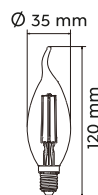

990-4470	clear	E14	4 W	470 lm	2.700 K	10.000 h		✓
990-4790	amber	E14	4 W	400 lm	2.700 K	10.000 h		✓

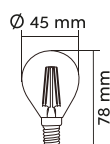

983-200	clear	E14	2 W	250 lm	2.700 K	10.000 h		
983-279	amber	E14	2 W	225 lm	2.700 K	10.000 h		
983-400	clear	E14	4 W	470 lm	2.700 K	10.000 h		
983-479	amber	E14	4 W	400 lm	2.700 K	10.000 h		

LED-LEUCHTMITTEL E14

LED bulbs E14 · Ampoules LED E14 · LED-lampen E14 · Bombillas a LED E14 ·
Lampadine a LED E14 · Becuri cu LED-uri E14 · LED-Valonlähdeet E14 · Żarówki LED E14

Code	Socket	Power	Lumen	Kelvin	Lifetime	Dimmable	Switch Dimmer	Switch Dim To Warm
------	--------	-------	-------	--------	----------	----------	---------------	--------------------



983-4470	clear	E14	4,5 W	470 lm	2.700 K	10.000 h		✓
983-4790	amber	E14	4 W	400 lm	2.700 K	10.000 h		✓



983-3200	clear	E14	2 W	250 lm	2.700 K	10.000 h		
983-3279	amber	E14	2 W	225 lm	2.700 K	10.000 h		

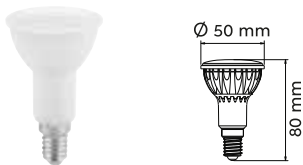

955-55	↙ 110°	E14	5 W	400 lm	3.000 K	25.000 h		
--------	--------	-----	-----	--------	---------	----------	--	--

LED-LEUCHTMITTEL G9

LED bulbs G9 · Ampoules LED G9 · LED-lampen G9 · Bombillas a LED G9 ·
Lampadine a LED G9 · Becuri cu LED-uri G9 · LED-Valonlähdeet G9 · Żarówki LED G9

Code	Socket	Power	Lumen	Kelvin	Lifetime	Dimmable	Switch Dimmer	Switch Dim To Warm
------	--------	-------	-------	--------	----------	----------	---------------	--------------------



Set 2

929-220	G9	2,5 W	210 lm	3.000 K	25.000 h			
---------	----	-------	--------	---------	----------	--	--	--



Set 2

929-2300	G9	3 W	300 lm	3.000 K	25.000 h	✓		
----------	----	-----	--------	---------	----------	---	--	--



Set 2

929-230	G9	3 W	300 lm	3.000 K	25.000 h		✓	
---------	----	-----	--------	---------	----------	--	---	--

LED-LEUCHTMITTEL GU10

LED bulbs GU10 · Ampoules LED GU10 · LED-lampen GU10 · Bombillas a LED GU10 ·
Lampadine a LED GU10 · Becuri cu LED-uri GU10 · LED-Valonlähteet GU10 · Żarówki LED GU10

Code	Socket	Power	Lumen	Kelvin	Lifetime	Dimmable	Switch Dimmer	Switch Dim To Warm
956-30	GU10	3 W	250 lm	3.000 K	20.000 h			
956-330	GU10	3 W	250 lm	3.000 K	15.000 h			
955-50	GU10	5 W	400 lm	3.000 K	25.000 h			
956-5936	GU10	5 W	400 lm	3.000 K	20.000 h	✓		
956-5736	GU10	5 W	400 lm	3.000 K	20.000 h		✓	
956-55	GU10	5 W	400 lm	3.000 K	25.000 h		✓	
956-355	GU10	5 W	400 lm	3.000 K	25.000 h		✓	
956-509	GU10	5 W	345 lm	2.200 K 2.700 K 3.000 K	25.000 h			✓

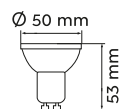
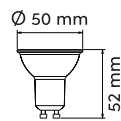
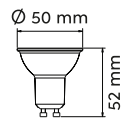
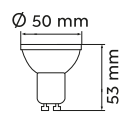
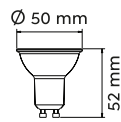
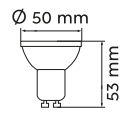
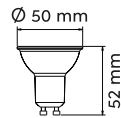
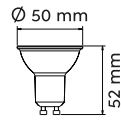

POS-LÖSUNGEN

POS solutions · Solutions de POS · POS-oplossingen ·
Soluciones POS · Soluzioni POS · Soluții POS · POS-ratkaisut · Rozwiązania POS

Leuchtmittel · Light sources



632

Tego-Regale
Tego shelves

↔ 1000/1250 mm
↑ 2400/2600 mm

RK53 Topper PT 0011 XX



RK52 Topper PT 0012 XX

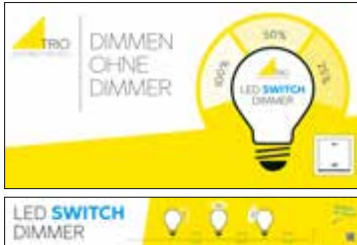

RK51 Topper PT 0013 CC



Display **RK53**
 ↔ 800 x 400 mm
 ↓ 1300 mm

Topper
 ↔ 800 mm, ↓ 400 mm



Display **RK78**
 ↔ 800 x 400 mm
 ↓ 1400 mm

Topper **PT0013**
 ↔ 800 mm, ↓ 400 mm



Display **PP005**
 ↔ 800 x 400 mm
 ↓ 1300 mm

Topper **PT0030**
 ↔ 600 mm, ↓ 350 mm

POS-LÖSUNGEN

POS solutions · Solutions de POS · POS-oplossingen ·
Soluciones POS · Soluzioni POS · Soluții POS · POS-ratkaisut · Rozwiązania POS

Einbauleuchten · Recessed lights



Tego-Regale
Tego shelves

↔ 1000/1250 mm
↓ 2400/2600 mm



Display **RK63**
↔ 1200 x 800 mm
↓ 2100 mm





Individuell planbar ·
individually plannable



Tego-Regale
Tego shelves

↔ 1000/1250 mm
↓ 2400/2600 mm

POS-LÖSUNGEN

POS solutions · Solutions de POS · POS-oplossingen ·
Soluciones POS · Soluzioni POS · Soluții POS · POS-ratkaisut · Rozwiązania POS

Badezimmerleuchten · Bathroom lighting



Tego-Regale
Tego shelves

↔ 1000/1250 mm
↓ 2400/2600 mm



Display **RK99**
↔ 1200 x 800 mm
↓ 2479 mm

POS-LÖSUNGEN

POS solutions · Solutions de POS · POS-oplossingen ·
Soluciones POS · Soluzioni POS · Soluții POS · POS-ratkaisut · Rozwiązania POS



Sticker
POST1033

Sticker
POST1034

Unterbauleuchten ·
Cabinet lights

Tego-Regale
Tego shelves

↔ 1000/1250 mm
↑ 2400/2600 mm

Deckenleuchten ·
Ceiling lamps

Display **RK58**
↔ 800 x 630 mm
↓ 1850 mm



Deckenleuchten ·
Ceiling lamps

Display **RK65**
↔ 2400 x 1400 mm
↓ 2400 mm



Pull switch
 Trekschakelaar
 Interruptore con tirata
 Vetokytkin
 dimmer

Steckdose - Plug
 Enise - Enchufe
 Priza - Káplács - Gámbócs

Vergrößerung 3x - Magnification 3x
 Magnification 3x - Vergrößerung 3x
 Ingrandimento 3x - Suplimentare 3x
 Powiększenie 3x

4 fach TOUCH - 4 level Touch function
 Interrupteur tactile 4 niveaux - Touch switch
 Función Táctil 4 nivel - Interruttore touch
 Intrerupator tactil 4 nivele - Kosketus
 Funkcja dotykowa 4 poziomy

Flexibel - Flexible
 Flexible - Flexibel
 Flexibil - Joustava

Lichtfarb
 variat
 Co



640 - 671

Spezifikationen

Specifications

Spécifications

Specifikaties

Especificaciones

Specifiche

Specificații

Tekniset tiedot

Specyfikacje

FARBEN & MATERIALIEN

Colours and materials · Couleurs et matériaux · Kleuren en materialen · Colores y materiales ·
Colori e materiali · Culori si materiale · Värit ja materiaalit · Kolory i materiały · Renkler ve malzemeler

- 00** Transparent · transparent
transparent · transparant · transparente · transparente ·
transparent · kirkas · przezroczysty · şeffaf
- 01** Weiß · white
blanc · wit · blanco · bianco · alb · valkoinen · biały · beyaz
- 02** Schwarz · black
noir · zwart · negro · nero · negru · musta · czarny · siyah
- 03** Messing poliert · polished brass
laiton polis · gepolijst messing · bronze · ottone lucido ·
bronz · messinki · mosiądz polerowany · piring
- 04** Altmessing · old brass
laiton fumé · oud brons · bronze viejo · ottone invecchiato ·
bronz antic · antiikkimessinki · patyna · antik piring
- 05** Aluminium gebürstet · brushed aluminium
aluminium balayé · geborsteld aluminium · aluminio pulido ·
alluminio spazzolato · aluminiu lucios · harjattu alumiini ·
aluminium szczotkowane · alüminyum
- 06** Chrom · chrome
chrome · chroom · cromo · cromo · crom ·
kromi · chrom · krom
- 07** Nickel matt · nickel mat
nickel mat · nikkelt mat · níquel mate · nichel opaco ·
nichel mat · harjattu teräs · nikiel mat · mat nikel
- 08** Messing matt · brass mat
laiton mat · messing mat · bronze mate · ottone satinato ·
bronz mat · mattamessinki · mosiądz mat · mat piring
- 09** Kupferfarbig · copper
cuivré · koperkleurig · color cobre · colore rame · cupru ·
kuperinvärinen · kolorze miedzi · bakir renkli
- 10** Rot · red
rouge · rood · rojo · rosso · rosu ·
punainen · czerwony · kırmızı
- 11** Grau · grey
gris · grijs · gris · grigio · gri · harmaa · popielaty · gri
- 12** Blau · blue
bleu · blauw · azul · azzurro · gri · sininen · niebieski · mavi
- 13** Amber · amber
ambre · amber · ámbar · ambra · amber · meripihka ·
bursztynowy · amber
- 14** Braun · brown
brun · bruin · marron · marrone · maro · ruskea ·
brązowy · kahverengi
- 15** Grün · green
vert · groen · verde · verde · verde · vihreä · zielony · yeşil
- 16** Gelb · yellow
jaune · geel · amarillo · giallo · galben ·
keltainen · żółty · sarı
- 17** mehrfarbig · multicolor
multicolore · multicolor · multicolor · multicolore ·
multicolor · monivärinen · multi-kolor · çok renkli
- 18** Orange · orange
orange · oranje · naranja · arancione · portocaliu ·
oranssi · pomarańczowy · turuncu
- 19** Türkis · turquoise
turquoise · turquoise · turquesa · turchese · turcoaz ·
turkoosi · turkusowy · turkuvaz
- 24** rostfarbig · rusty
rouille · roestkleur · óxido · ruggine · ruginiu · rustiikki ·
miedz · pas
- 26** Braun · brown
brun · bruin · marron · marrone · maro · ruskea ·
brązowy · kahverengi
- 27** Weiß antik · antique white
blanc antique · antiek wit · blanco decapé · bianco anticato ·
alb antic · antiikkivalkoinen · antyczny biały · antik beyaz
- 28** rostfarbig antik · antique rust
rouille antique · roestkleur antiek · oxido · ruggine anticato ·
ruginiu antic · rustiikki · antyczny rdzawy · antik pas rengi
- 29** Kupfer matt · copper mat
cuivre mat · koper mat · estera de cobre · rame opaco ·
cupru mat · kupari mat · miedz mat · bakır mat
- 30** holzfarbig · wood coloured
couleur bois · houtkleur · color maderá · colore di legno ·
culoare lemn · puunvärinen · kolor drewna · ahşap renk
- 31** Weiß matt · white mat
blanc mat · wit mat · estera blanca · bianco opaco · alb mat ·
valkoinen matto · biały mat · beyaz mat
- 32** Schwarz matt · black mat
noir mat · mat zwart · estera negra · nero opaco ·
negru mat · musta matto · czarny mat · siyah mat
- 41** Taupe · taupe
taupe · taupe · gris pardo · taupe · taupe ·
ruskeanharmaa · ciemnoszary · taupe
- 42** Anthrazit · anthracite
antracite · antraciet · antracita · antracite · antracit ·
antrasiitti · antracyt · antrasit
- 45** Pastellblau · pastel blue ·
bleu pastel · pastel blauw · azul pastel · azzurro pastello ·
albastru pastel · pastellinsininen · pastelowy niebieski ·
pastel mavi
- 51** Apfelgrün · applegreen
vert pomme · appelgroen · verde manzana · verde mela ·
verde mar · omenanvihreä · zielone jabłko · elma yeşili
- 52** Transparent klar · transparent clear
transparente claire · transparant helder · transparente claro ·
transparente chiaro · transparent clar · kirkas ·
przezroczysty · şeffaf

- 54** rauchfarbig · smoke
fumé · rookkleur · humo · fume' · fumuriu ·
savu · przydymiony · duman
- 61** Grau antik · antique grey
gris ancien · antiek grijs · gris antiguo · grigio antico ·
antic gri · antiikki harmaa · starodawny szary · antika gri
- 62** Kupfer antik · antique copper
cuivre ancien · antiek koper · cobre antiguo · rame antico ·
cupru antic · antiikki kupari · antyczne miedzi · antik bakır
- 64** Bronze · bronze
bronze · bronze · bronce · bronzo · bronz ·
pronssi · brąz · tunç
- 67** Nickel antik · nickel antique
nickel antique · antiek nikkell · níquel antiguo · nickel anticato ·
nichel antic · antiikkiteräs · aikiel antyczny · antik nikel
- 78** betonfarbig · concrete look
couleur beton · beton kleur · color concreto ·
calcestruzzo · culoare beton · konkreettisia väri ·
konkretny kolor · beton rengi
- 79** goldfarbig · gold
or · goud · oro · oro · aur · kultaa · złota · altın
- 87** titanfarbig · titan
titane · titaan · titán · titano · titaniu ·
titaani · tytanowy · titan
- 88** Silber antik · antique silver
argent antique · antiek zilver · plateado antiquo ·
argento anticato · argint antic · antiikkihopea ·
antyczne srebro · gümüş antika
- 89** silberfarbig · silver
argent · zilver · plata · argento · argint ·
hopea · srebrny · gümüş
- 91** Lila · lilac
lilla · lilla · lila · lilla · lila · lila · liliowy · leylak
- 92** Purpurrot · purple
pourpre · paars · púrpura · porpora · purpuriu ·
purppura · purpurowy · mor
- 93** Pink · pink
rose · pink · rosa · rosa · roz · pinkki · różowy · pembe
- 94** Pastellrosa · pastel pink ·
rose pastel · pastel rose · rosa pastel · rosa pastello ·
roz pastel · pastellin pinkki · pastelowy róż · pastel pembe

PRODUKTEIGENSCHAFTEN

Features · Caractéristiques · Kenmerken · Acabados ·
Caratteristiche · Caracteristici · Ominaisuudet · Cechy



Schalter · Switch

Interrupteur · Schakelaar · Interruptor ·
Interruttore · Intrerupator · Kytkin ·
Przełącznik



Fußschalter · Footswitch

interrupteur à pédale · Voetschakelaar ·
Interruptor de pie · interruttore a pedale ·
comutator picior · Päälle / pois jalkakytin ·
wyłącznik nożny



Schnurschalter · Cable switch

Interrupteur de cordon · Snoerschakelaar ·
Cable de interruptor · Interruttore su cavo ·
Intrerupator cu cablu · katkaisin ja johto ·
Przełącznik na kablu



On/Off Touch Funktion · On/Off Touch function

Interrupteur tactile On/Off · Touch schakelaar On/Off ·
Función táctil On/Off · Interruttore touch On/Off ·
Intrerupator tactil On/Off · Kosketuskäyttöinen On/Off ·
Funkcja dotykowa On/Off



Getrennt schaltbar · Separately switchable

Interrupteurs séparés · Gescheiden schakelbaar ·
Interruptores separados · Interruttori separati ·
Intrerupatoare separate · Erikseen kytkettävissä ·
Oddzileny przełącznik



Fernbedienung · Remote control

Commande à distance · Afstandsbediening ·
Mando a distancia · Comando a distanza ·
Telecomanda · Kauko-ohjain · Pilot



Integrierter Dimmer · Integrated dimmer

Variateur intégré · Geïntegreerde dimmer ·
Regulador integrado · Dimmer integrato ·
Variator de lumina integrat · Integroitu himmennin ·
Wbudowany ściemniacz



Zugschalter · Pull switch

Interrupteur de trait · Trekschakelaar ·
Interruptor de tiro · Interruttore con tirata ·
Interupator de tragere · Vetokytin ·
Przełącznik pociągany



Sensordimmer · Sensor dimmer

Variateur tactile · Touchdimmer ·
Regulador con sensor · Touchdimmer ·
Variator cu senzor · Kosketushimmennin ·
Czujnik ściemniania



Extern dimmbar · Externally dimmable

Dimmable avec variateur externe · Extern dimbaar ·
Dimmable por regulador externo · Dimmerabile con dimmer
esterno · variator extern de lumina · himmennettävissä ·
Zewnętrznie ściemniana



RGB Farbwechsler · RGB Colorchanging

Changement de couleur RGB · RGB Kleurverandering ·
Cambio de color RGB · Cambia colore RGB ·
Schimbator de culoare RGB · Värinvaihto RGB ·
Zmieniający kolor RGB



Lichtfarbe einstellbar · Adjustable light color

Couleur de lumière réglable · Lichtkleur instelbaar ·
Color de luz regulable · Colore della luce regolabile ·
Lumina colorata reglabila · Värilämpötila säädettävissä ·
Regulowana barwa światła



Höhenverstellbar · Adjustable height

Hauteur réglable · In hoogte verstelbaar ·
Altura regulable · Altezza regolabile ·
Inaltime reglabila · Säädettävä korkeus ·
Regulowana wysokość



Schwenkbar · Tiltable

Pivotant · Draaibaar · Pivotante ·
Girevole · Pivotant · Suunnattava ·
Skrętny



Steckdose · Plug

Prise · Stekker · Enchufe · Spina ·
Priza · Katkaisin · Gniazdko



Vergrößerung 3x · Magnification 3x

Magnification 3x · Vergroting 3x · Aumentos 3x ·
Ingrandimento 3x · Suplimentare 3x · Suurentava 3x ·
Powiększenie 3x



4 fach TOUCH · 4 level Touch function

Interrupteur tactile 4 niveaux · Touch schakelaar 4 niveaus ·
Función Táctil 4 nivel · Interruttore touch 4 livelli ·
Intrerupator tactil 4 nivele · Kosketuskäyttöinen 4 taso ·
Funkcja dotykowa 4 poziomy



Flexibel · Flexible

Flexible · Flexibel · Flexible · Flessibile ·
Flexibil · Joustava · Elastyczne



Lichtfarbe stufenlos einstellbar ·
Light color infinitely variable
Couleur de lumière infiniment variable · Lichtkleur
traploos instelbaar · Color de luz infinitamente variable ·
Colore della luce infinitamente variabile · Culoare lumină
infiniit variabilă · Valon väri portaattomasti · Jasny kolor
bezstopniowo



USB Anschluss · USB connection
Entrée USB · USB aansluiting · Conexión USB ·
Connessione USB · Conexiune USB · USB-liitäntä ·
Połączenie USB



USB Anschluss mit Ladefunktion ·
Recharging USB connection
Entrée USB de rechargement · Opladende USB
aansluiting · Conexión USB de recarga · Connessione
USB di ricarica · Conexiune USB reîncărcare ·
Lataaminen USB-liitäntä · ładowania USB połączenie



Nachtlicht · Night light
Veilleuse de nuit · Nachtlicht · Luz de la noche ·
Luce notturna · Lampă de noapte · Yövalo ·
Lampka nocna



Gestensteuerung · Gesture control
Contrôle gestuel · Gebarenbediening · Control gestual ·
Controllo gestuale · Control prin gesturi/mișcarea mâinii ·
Kädellä ohjattava liiketunnistin · Sterowana gestami



Up and down Beleuchtung · Up and Down lighting
Point lumineux en haut et en bas · Lichtpunt boven en
onder · Luz de arriba y abajo · Luce su e giù · Sus și în
jos lumina · Ylös ja alas valoa · W górę iw dół światło



Dimmbar mit Schalter · Dimmable via switch
Réglable avec interrupteur · Dimbaar via schakelaar ·
Regulable mediante interruptor · Dimmerabile tramite
interruttore · Estompat prin comutator · Himmennettävä
kytkimen · Ściemnialne za pośrednictwem przełącznika



Musterschutz · Registered model
Modèle déposé · Beschermd model ·
Modelo certificado · Modello depositato ·
Înregistrați model · Rekisteröity malli ·
Zarejestrowany wzór



Starlight Effekt · Starlight effect
Effet étoiles · Starlight effekt · Efecto estrella ·
Effetto stelle · Efect de "stele" · Tähti efekti ·
Efekt starlight



RGBW Farbwechsler · RGBW Colorchanging
Changement de couleur RGBW · RGBW Kleurverandering ·
Cambio de color RGBW · Cambia colore RGBW ·
Schimbator de culoare RGBW · Värvinvaihto RGB ·
Zmieniający kolor RGBW



Ohne Leuchtmittel · Lamp(s) excluded
Sans ampoule(s) · Zonder lichtbron(nen) ·
Sin bombilla(s) · Lampadina Esclusa · Fara bec (s) ·
Ilman polttimo (s) · Bez żarówki (s)



SWITCH DIM TO WARM
Lichtfarbe mit Schalter einstellbar ·
Light color adjustable with switch
Couleur de lumière réglable avec interrupteur · Lichtkleur
instelbaar met schakelaar · Color de la luz ajustable con
interruptor · Colore della luce regolabile con interruttore ·
Culoarea luminii reglabila cu un comutator · Valon väri
säädettävällä kytkimellä · Kolor światła regulowane z
przełącznikiem



Ausziehbar · Extendible
extensible · Verlengbaar · Extensible ·
Estensibile · extensibila · Jatkettava ·
Rozsuwalny



Memory Funktion · Memory function
fonction mémoire · Geheugen functie ·
Función de memoria · Funzione memorizzazione ·
functia memorie · Muistitoiminto · Funkcja pamięci



indirekte Beleuchtung · indirect lighting
lumière indirecte · indirecte belichting ·
Iluminación indirecta · Illuminazione a scomparsa ·
iluminat indirect · epäsuora valaistus ·
oświetlenie pośrednie



DIP SWITCH
Lichtfarben direkt an der Leuchte einstellbar ·
Colours directly adjustable at the lamp
Les couleurs de la lumière peuvent être réglées directement
sur le luminaire · Lichtkleuren direct instelbaar op de lamp ·
Tonalidades de luz ajustables directamente en la lámpara ·
Colori della luce regolabili direttamente sulla lampada ·
Culori ale luminii reglabile direct de la bec · Valon väri
asetettävissa suoraan valaisimesta · Barwy światła można
ustawić bezpośrednio na oprawie

LED SWITCH DIMMER

DIMMEN OHNE DIMMER DIMMING WITHOUT DIMMER



100%

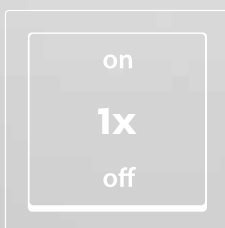

Licht einschalten
Switch on the light



50%



Mehrmals Licht aus- und sofort wieder einschalten
Switch off the light and switch it immediately on again



25%



Helligkeit bequem mit jedem
herkömmlichen Lichtschalter steuern

*Adjusting the desired level of brightness with any
conventional light switch*



DIP SWITCH



Mittels DIP SWITCH können drei Lichtfarben (Warmweiß, Neutralweiß, Tageslichtweiß) über einen Schalter direkt an der Leuchte eingestellt werden.

The DIP SWITCH directly sets the luminaire's three light colours (warm, neutral and daylight white).

2.300 K

Warmweiß · warm

3.000 K

Neutralweiß · neutral

4.000 K

Tageslichtweiß · daylight white



Diese Wandleuchte ist sowohl für den Festanschluss, als auch für den Betrieb mit Steckerzuleitung geeignet.

This wall light is suitable both for a fixed power connection, as well as for the connection of a plug-in power cable.

Cette applique convient à la fois pour une connexion d'alimentation fixe, ainsi que pour la connexion d'un câble d'alimentation enfichable.

Deze wandlamp is zowel geschikt voor een vaste stroomaansluiting als voor het aansluiten van een plug-in voedingskabel.

Esta luz de pared es adecuada tanto para una conexión de alimentación fija como para la conexión por cable de alimentación

Questa lampada da parete è adatta sia per una connessione di alimentazione fissa, sia per la connessione di un cavo di alimentazione plug-in.

Aceasta aplica este potrivita atat pentru a fi montata direct la sursa de curent, dar si pentru a fi conectata printr-un cablu de curent la priza.

Tämä seinävalaisin voidaan asentaa kiinteästi kytkentäriman avulla tai käyttämällä mukana tulevaa liitosjohtoa.

Ta lampa ścienna jest odpowiednia zarówno do podłączenia na stałe, jak również do eksploatacji przy użyciu przewodu z wtyczką.

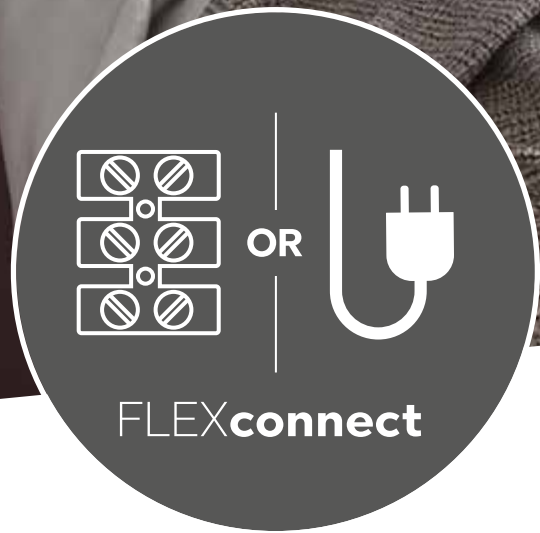

GARANTIEERKLÄRUNG

Warranty Statement · Déclaration de garantie · Garantieverklaring ·
Declaración de garantía · Dichiarazione di garanzia ·
Declarație de garanție · Takuuehdot · Oświadczenie o gwarancji



TRIO übernimmt gegenüber Verbrauchern für alle Leuchten mit fest verbauten LEDs, die ab dem 01.04.2017 (Kaufdatum) gekauft wurden, eine freiwillige LED-Funktionsgarantie von 5 Jahren und für alle Leuchten mit fest verbauten LEDs, die vor dem 01.04.2017 gekauft wurden, eine freiwillige LED-Funktionsgarantie von 3 Jahren. Nähere Informationen hierzu finden Sie in der Garantieerklärung auf unserer Internetseite.

www.trio-leuchten.de

TRIO takes on a voluntary LED functional warranty of 5 years to consumers of lamps with integrated LEDs bought on or after 01/04/2017 (purchase date), and 3 years for lamps with integrated LEDs bought before 01/04/2017. For further information, please visit our website.

www.trio-lighting.com

TRIO offre aux consommateurs une garantie volontaire de fonctionnement de 5 ans pour toutes les luminaires à LED intégrées achetées après le 01.04.2017 (date d'achat), et de 3 ans pour toutes les luminaires à LED intégrées achetées avant le 01.04.2017. Pour plus d'information, consultez notre site.

www.trio-lighting.com

TRIO verleent tegenover verbruikers voor alle armaturen met vast gemonteerde LED's die vanaf 01.04.2017 (aankoopdatum) werden gekocht, een vrijwillige LED-functiegarantie van 5 jaar en voor alle armaturen met vast gemonteerde LED's die voor 01.04.2017 werden gekocht, een vrijwillige LED-functiegarantie van 3 jaar. Voor meer informatie, consulteer onze website.

www.trio-lighting.com

TRIO ofrece a sus consumidores una garantía voluntaria de servicio de los LED de 5 años de duración para todas las lámparas con LED fijos adquiridas a partir del 01.04.2017 (fecha de compra) y de 3 años de duración para todas las lámparas con LED fijos adquiridas antes del 01.04.2017. Para más información, por favor visite nuestra página web.

www.trio-lighting.com

Ai consumatori, TRIO offre su tutti gli apparecchi sui quali sono montate sorgenti LED integrate, acquistate a partire dal 01/04/2017 (data di acquisto), una garanzia commerciale di funzionamento di 5 anni per gli apparecchi LED e su tutti gli apparecchi sui quali sono montate sorgenti LED integrate acquistate prima del 01/04/2017 una garanzia commerciale di funzionamento di 3 anni per gli apparecchi LED. Per ulteriori informazioni, vi preghiamo di visitare il nostro sito web.

www.trio-lighting.com

TRIO ofera consumatorilor o garanție comercială de 5 ani, pentru toate corpurile de iluminat cu LED-uri incorporate, care au fost vândute începând cu 01.04.2017 (data achiziției), și pentru toate corpurile de iluminat cu LED-uri incorporate, care au fost vândute înainte de 01.04.2017, o garanție comercială de 3 ani pentru funcționarea LED-urilor. Pentru mai multe detalii, va rugăm să vizitați site-ul TRIO.

www.trio-lighting.com

TRIO myöntää kuluttajille vapaaehtoisen ledien toimivuustakuun. TRIO-valikoiman valaisimissa, joissa on kiinteästi asennetut ledit ja jotka on ostettu 1.4.2017 jälkeen (hankintapäivä), ledien takuu-aika on 5 vuotta. Valaisimissa, joissa on kiinteästi asennetut ledit ja jotka on ostettu ennen 1.4.2017, ledien takuu-aika on 3 vuotta. Lisätietoja verkkosivuiltamme.

www.trio-lighting.com

TRIO udziela konsumentom na wszystkie lampy z asortymentu TRIO z zamontowanymi na stałe diodami LED, które zakupione zostały od dnia 01.04.2017 r. (data zakupu), dobrowolnej gwarancji na działanie diod LED na okres 5 lat i na wszystkie lampy z zamontowanymi na stałe diodami LED, które zakupione zostały przed dniem 01.04.2017 r., dobrowolnej gwarancji na działanie diod LED na okres 3 lat. Na naszej stronie internetowej może Państwo uzyskać więcej informacji na ten temat.

www.trio-lighting.com

GET YOUR LIGHT CONNECTED.

FR NL ES IT RO FI PL

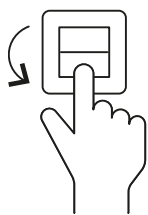

WiZ CLICK

Simple et efficace. Deux modes d'éclairage préférés peuvent être commandés via l'interrupteur d'éclairage existant.

Eenvoudig en effectief. Twee voorkeurstellingen kunnen worden bediend via de bestaande lichtsckakelaar.

Helppoa ja tehokasta. Kaksi toivottua valo asetusta jota voidaan käyttää seinäkytkimellä.

Simplu si efectiv. Pot fi operate 2 moduri de iluminat preferate prin comutatorul de lumina existent.

Semplice ed efficace. È possibile utilizzare due modalità di illuminazione preferite tramite l'interruttore della luce esistente.

Simple y efectivo. Dos ambientes de luz preferidos pueden operar a través del interruptor convencional.

Proste i efektywne. Dwa preferowane tryby oświetlenia można obsługiwać za pomocą dostępnego przełącznika oświetlenia.

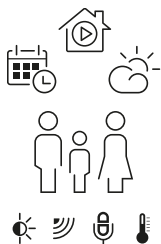

WiZ MAGIC

Contrôle des lumières par programme horraire, par capteurs ou par simples commandes vocales. Compatible avec Amazon Alexa et Google Home.

Aansturing van de lampen met tijdschema's, door sensoren of via eenvoudige spraakopdrachten. Compatibel met Amazon Alexa en Google Home.

Valoja voi säätää aikataulutetusti, sensoreilla tai yksinkertaisilla ääni komennoilla. Yhteensopiva Amazon Alexan ja Google Homen kanssa.

Controlul luminilor prin programarea orei/timpului ,cu senzori sau printr-o simpla comanda verbala.Compatibil cu Amazon Alexa si Google Home.

Controllo delle luci secondo gli orari, con sensori o semplici comandi verbali. Compatibile con Amazon Alexa e Google Home.

Control de las luces con horarios, con sensores o por simples comandos de voz. Compatible con Alexa de Amazon y Google Home.

Ustawianie i sterowanie lampami za pomocą harmonogramów.



WiZ APP

Installation facile et rapide. Toutes les fonctionnalités et flexibilité disponible avec l'application WiZ, téléchargeable sur App Store ou Google Play.

Eenvoudig en snel te installeren. Volledige functionaliteit en flexibilititeit met de WiZ-app - beschikbaar in de App Store of op Google Play.

Helppo ja nopea asentaa. Käyttö WiZ-aplikaatiolla - saatavissa App Storesta tai Google Play kaupasta.

Instalare usoara si rapida.Functionalitate completa si flexibilitate cu WIZ App -disponibil pe App store sau pe Google Play.

Facile e veloce da installare.Piena funzionalità e flessibilità con l'App WiZ disponibile su App Store e su Google Play.

Fácil y rápido de instalar. Amplia funcionalidad y flexibilidad con la aplicación WiZ, disponible en la App Store o en Google Play.

Prosta i szybka instalacja. Pełna funkcjonalność i elastyczność dzięki aplikacji WiZ – dostępnej w App Store lub Google Play.



WiZ MOTE

Contrôle via la télécommande et possibilité de sauvegarder quatre modes d'éclairage favoris.

Aansturen via de afstandsbediening en mogelijkheid om vier favoriete licht instellingen te bewaren.

Toimintojen säätö kaukosäätimellä ja mahdollisuus tallentaa neljä valo asetusta.

Controlul prin telecomanda si posibilitatea de a memora/salva 4 moduri favorite.

Controllo tramite telecomando e possibilità di salvare quattro modalità luce preferite.

Control vía mando a distancia y con posibilidad de guardar 4 ambientes favoritos.

Możliwość sterowania za pomocą pilota i zapisywania czterech preferowanych trybów oświetlenia.



Résidences multiples

Contrôlez et commandez plusieurs résidences simultanément et de n'importe où. Que ce soit votre propre maison ou votre deuxième résidence.

Meerdere locaties

Controleren en aansturen van meerdere locaties tegelijkertijd en van overal. Uw thuis of uw vakantiehuis.

Useita sijainteja

Voit hallita useita sijainteja, kotiasi tai kesäasuntoasi samanaikaisesti.

Locatii Multiple

Control si comanda a locatiilor multiple simultan si de oriunde .Fie ca te afli acasa sau in casa de vacanta

Molteplici Location

Controlla e comanda più sedi contemporaneamente e da qualsiasi luogo. Che tu sia casa tua o la tua casa vacanza.

Múltiples localizaciones

Control y cambio en múltiples localizaciones simultáneamente, tanto tu casa como en tu segunda residencia.

Kilka lokalizacji

Kontrola i sterowanie z kilku lokalizacji jednocześnie i zewsząd. Czy to z własnego domu, czy też z wakacyjnego mieszkania.

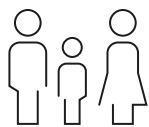

Multiplés utilisateurs

Le nombre de personnes pour contrôler les lumières peut être déterminé individuellement.

Meerdere gebruikers

Het aantal personen dat de lampen aanstuurt, kan individueel worden ingesteld.

Monta eri käyttäjää

WiZ käyttäjien määrä voidaan yksilöllisesti määrittää.

Utilizatori multipli

Numarul de persoane care sa controleze luminile poate fi setat individual.

Molteplici Utenti

Il numero di persone per controllare le luci può essere impostato individualmente.

Múltiples usuarios

El número de personas que controlan las luces se puede configurar individualmente.

Kilku użytkowników

Liczba użytkowników mogących sterować lampami może być określana indywidualnie.



Basé sur le cloud

WiZ se connecte au cloud pour stocker les préférences, partager les désirs et générer automatiquement des mises à jour.

Cloud gebaseerd

WiZ maakt verbinding met de cloud om voorkeuren op te slaan, wensen te delen en automatische updates te genereren.

Pilvipalveluun perustuva

WiZ ottaa yhteyden pilvipalveluun, tallentaa asetukset ja luo päivitykset automaattisesti.

Pe baza de Cloud

WiZ te conectează la Cloud la magazinul preferat, transmite dorințele și generează update-uri în mod automat.

Basato sul Cloud

WiZ si connette al cloud per memorizzare le preferenze, condividere desideri e generare automaticamente gli aggiornamenti.

Basado en la nube

WiZ conecta con la nube para guardar tus preferencias, comparte y genera actualizaciones automáticamente.

Oparte na chmurze

WiZ łączy się z chmurą, aby zapisywać preferencje, rozdzielać życzenia i automatycznie generować aktualizacje.



Lieux multiples

Toutes les lumières peuvent être assignées à différentes pièces et contrôlées avec précision - individuellement ou en groupe.

Meerder woonruimtes

Alle lampen kunnen worden toegewezen aan verschillende woonruimtes en nauwkeurig worden aangestuurd - individueel of in groepen.

Useita huoneita

Jokainen valo voidaan määrittää eri huoneelle. Hallittavissa ryhmissä tai yksittäin.

Câteva camere

Toate luminile pot fi atribuite mai multor camere diferite si pot fi controlate cu precizie -individual sai in grupuri

Numerose stanze

Tutte le luci possono essere assegnate a stanze diverse e controllate con precisione - individualmente o in gruppi.

Varias habitaciones

Todas las luces pueden ser asignadas a diferentes habitaciones y controladas con precisión - individualmente o en grupo.

Kilka pomieszczeń

Wszystkie lampy mogą być przyporządkowywane do różnych pomieszczeń i precyzyjnie sterowane – pojedynczo lub w grupach.



Pas besoin de pont

Il n'y a pas besoin d'un dispositif supplémentaire pour contrôler les lumières.

Geen hub nodig

Er is geen extra apparaat nodig om de lampen aan te sturen.

Ei tarvetta erilliselle keskukselle

Ei tarvetta erilliselle keskukselle valojen säätämiseen.

Nu e nevoie de nici un punct central

Nu e nevoie de o punte sau hub pentru a controla luminile

Non sono necessari altri hub

Non è necessario un ponte o un hub aggiuntivo per controllare le luci

No necesaria una unidad central

No es necesario una conexión adicional o unidad central para controlar las luces

Bez konieczności stosowania dodatkowych mostków

Do sterowania lampami nie jest potrzebny żaden dodatkowy mostek.



Technologie WiFi

WiZ utilise la technologie WiFi comme une solution sans fil sécurisée, indépendante, abordable et facile à installer.

WiFi-technologie

WiZ gebruikt Wi-Fi-technologie als een veilige, onafhankelijke, betaalbare en eenvoudig te installeren draadloze oplossing.

WiFi teknologia

WiZ käyttää Wi-Fi teknologiaa turvallisena, itsenäisenä, edullisena ja helppo käyttöisenä langattomana ratkaisuna.

Technologie Wi-Fi

WiZ folosește tehnologia Wi-Fi ca o soluție de internet sigură, independentă, permisivă și ușor de instalat.

Tecnologia Wi-Fi

WiZ utilizza la tecnologia Wi-Fi come soluzione wireless sicura, indipendente, economica e facile da installare.

Tecnología WiFi

WiZ utiliza la tecnología Wi-Fi como una solución inalámbrica segura, independiente, asequible y fácil de instalar.

Tecnologia WLAN

WiZ używa technologii „WLAN” jako bezpiecznego, niezależnego, niskonakładowego i łatwego w instalacji rozwiązania radiowego.

DUOLINE

Système de voie à deux phases (230 V) · 2-fase-spoorsysteem (230 V) · Sistema de rieles en 2 fases (230 V) · Sistema a binario bifase (230 V) · Sistem de piste cu 2 faze (230 V) · 2-vaihekiskojärjestelmä (230 V) · 2-fazowy system prowadnic (230 V)

FR NL ES IT RO FI PL

Les avantages de DUOLINE en un coup d'œil :

- Conception individuelle de l'éclairage
- Une seule connexion électrique requise
- Pas besoin de transformateur
- Les luminaires peuvent être librement combinés et facilement déplacés
- Deux scénarios lumineux différents
- Commutation et variateur de lumière séparés
- Convient pour le montage au plafond et au mur

Lors de la planification, veuillez prêter une attention particulière à la position du conducteur de protection, qui doit être connecté en permanence dans le système.

I vantaggi di DUOLINE in sintesi:

- Progettazione individuale dell'illuminazione
- È necessario un solo collegamento di alimentazione
- Non è necessario alcun trasformatore
- Le lampade possono essere liberamente combinate e facilmente spostate
- Due differenti scenari di illuminazione
- Commutazione e dimmerazione separate
- Adatto per il montaggio a soffitto e a parete

In fase di progettazione, prestare attenzione alla posizione del conduttore di protezione, che deve essere collegato in modo continuo all'interno dell'impianto.

Zalety DUOLINE w skrócie:

- Indywidualny projekt oświetlenia
- Wymagane jest tylko jedno połączenie zasilania
- Nie wymaga transformatora
- Oprawy można dowolnie łączyć i łatwo przemieszczać
- Dwa różne scenariusze oświetlenia

1 Rail

La longueur maximale de l'installation est de 30 mètres par alimentation, avec une puissance totale maximale de 600 watts par phase.

Spoor

De maximale montage lengte bedraagt 30 meter per voeding, bij een een totaal vermogen van max. 600 watt per fase.

Riel

La longitud máxima de montaje es de 30 metros por alimentación, con una potencia total de 600 vatios como máximo por fase.

Binario

La lunghezza massima di installazione è di 30 metri per ogni alimentazione, con una potenza totale di max. 600 watt per fase.

Pistă

Lungimea maximă de montaj este de 30 de metri pe fiecare sursă de alimentare, la o putere totală de max. 600 W pe fază.

Kisko

Asennuksen enimmäispituus on 30 metriä syöttöä kohti, kokonaisteho enintään 600 W/vaihe.

Szyna

Maksymalna długość montażu wynosi 30 metrów na linię zasilania z łączną mocą 600 watów na jedną fazę.

2 Alimentation électrique intermédiaire/finale

L'alimentation du milieu/extrémité est montée directement au-dessus de la prise de courant et permet de connecter des rails d'un côté ou des deux côtés.

Midden-/eindevoeding

De midden-/eindevoeding wordt direct over de stroomuitgang aangebracht en maakt het mogelijk sporen op één of beide kanten aan te sluiten.

Alimentación medios/extremos

La alimentación de medios/extremos se adapta directamente mediante la toma de corriente, y permite que las lámparas se conecten por un lado o por los dos.

Alimentazione centrale/finale

L'alimentazione centrale/finale è montata direttamente sopra la presa di corrente e

Overzicht van de voordelen van DUOLINE:

- Individuele lichtvormgeving
- Slechts één stroomaansluiting nodig
- Geen transformator nodig
- Lampen willekeurig combineerbaar en gemakkelijk verplaatsbaar
- Twee verschillende lichtscenario's
- Apart schakelen en dimmen
- Geschikt voor plafond- en muurmontage

Let bij de planning absoluut op de positie van de beschermende geleider die binnen het systeem ononderbroken verbonden moet zijn.

Avantajele DUOLINE dintr-o privire:

- Structurarea individualizată a luminii
- Este necesară o singură conexiune electrică
- Nu este necesar un transformator
- Lămpile pot fi combinate liber și pot fi deplasate cu ușurință
- Două scenarii de iluminat diferite
- Comutare și reglare a intensității separate
- Adecvat pentru montajul pe plafon și pe perete

La planificare, luați neapărat în considerare poziția conductorului de protecție, care trebuie să fie conectat continuu în interiorul sistemului.

- Oddzielne włączanie i ściemnianie
- Nadaje się do montażu sufitowego i ściennego

Podczas projektowania należy zwrócić uwagę na położenie przewodu ochronnego, który musi być podłączony w całym systemie.

Las ventajas de DUOLINE en resumen:

- Diseño lumínico individual
- Solo un cable de corriente necesario
- Ningún transformador necesario
- Lámpara combinables libremente y fácilmente desplazable
- Dos escenarios lumínicos diferentes
- Activación y atenuación separadas
- Adecuado para su montaje en techo y pared

Al planificar, por favor, tenga en cuenta la posición de la toma de tierra, que debe estar conectado a lo largo de todo el sistema.

DUOLINEN EDUT LYHYESTI:

- Yksilöllinen valaistus suunnittelu
- Vaaditaan vain yksi sähköliitäntä
- Muuntajaa ei tarvita
- Valaisimia voidaan yhdistellä vapaasti ja siirtää helposti
- Kaksi erilaista valaistusskenaariota
- Erillinen kytkentä ja himmennys
- Sopii katto- ja seinäasennukseen

Huomioi suunnittelussa koko järjestelmään kytkettävän suojaadoituksen sijainti.

consente di collegare le guide su un lato o su entrambi i lati.

Alimentare centrală/finală

Alimentare centrală/finală este realizată direct prin intermediul conexiunii electrice și permite conectarea pistolor pe o parte sau pe ambele părți.

Keski-/päätsyöttö

Keski-/päätsyöttö asennetaan suoraan pistorasian yläpuolelle, ja se mahdollistaa kiskojen kytkemisen toiselle tai molemmille puolille.

Zasilanie pośrednie / końcowe

Zasilanie środkowe / końcowe jest instalowane bezpośrednio nad gniazdem zasilania i umożliwia podłączenie szyn z jednej lub z obu stron.

3 Alimentation intermédiaire/finale avec changeur de phase électronique

Grâce à un changeur de phase électronique, les deux phases peuvent être commutées et atténuées séparément, même avec des lignes électriques à trois conducteurs.

Midden-/eindevoeding met elektronische fasewisselaar

Door middel van een elektronische fasewisselaar kunnen de twee fasen ook bij driedradige stroomleidingen apart geschakeld en gedimd worden.

Alimentación medios/extremos con cambiador de fase electrónico

Por medio de los cambiadores de fase electrónicos, las dos fases pueden activarse y atenuarse también mediante cables de corriente de tres filamentos.

Alimentazione centrale/finale con variatore di fase elettrico

Mediante un variatore di fase elettrico, le due fasi possono essere commutate e dimmerate separatamente, anche con linee di alimentazione a tre conduttori.

Alimentare centrală/finală cu schimbător electronic de fază

Prin intermediul dispozitivului electronic de schimbare a fazelor se pot comuta și regla două faze chiar și în cazul cablurilor electrice cu trei fire.

Keski-/päätsyöttö elektronisella vaihtimella

Sähköistä vaihdinta käyttämällä nämä kaksi vaihtetta voidaan kytkeä ja himmentää erikseen jopa kolmijohtimisella kaapeloinnilla.

Zasilanie pośrednie / końcowe z elektronicznym przełącznikiem faz

Za pomocą elektronicznych zmieniaczy faz obie fazy można przełączać i przyćmieniać osobno, nawet w przypadku trójprzewodowych linii zasilania.

4 Alimentation électrique flexible

L'alimentation électrique flexible est nécessaire si les rails ne peuvent pas être posés directement sur la prise de courant.

Flexibele stroomtoevoer

Flexibele stroomtoevoer is nodig, als de sporen niet direct over de stroomuitgang gelegd kunnen worden.

Suministro de corriente flexible

El suministro de corriente flexible será necesario si las lámparas no pueden desplegarse directamente sobre la toma de corriente.

Sistema di alimentazione flessibile

Il sistema di alimentazione flessibile è necessario se i binari non possono essere posati direttamente sulla presa di corrente.

Alimentarea electrică flexibilă

Alimentarea electrică flexibilă este necesară atunci când pistele nu pot fi pozate direct prin intermediul racordului electric.

Joustava virtansyöttö

Joustava virtalähde on tarpeen, jos kiskoja ei voida asentaa suoraan pistorasian yläpuolelle.

Elastyczne zasilanie

Elastyczny zasilanie jest wymagane, jeśli szyny nie mogą być układane bezpośrednio nad gniazdem zasilania.

5 Connecteur longitudinal

Relie deux rails entre eux pour des sections droites.

Longitudale verbinder

Verbindt twee sporen voor rechte stukken met elkaar.

Ensamblaje recto

Ensamble dos rieles para tramos rectos entre si.

Connettore longitudinale

Unisce due binari per sezioni rettilinee.

Conector longitudinal

Conectează două piste pentru trasee drepte unele cu altele.

Suora liitin

Yhdistää kaksi kiskoa suoria osuuksia varten.

Przedłużacz

Łączy dwie szyny dla prostych odcinków.

6 Connecteur Flex

Relie deux rails entre eux sous n'importe quel angle et relie le montage au plafond à celui au mur.

Flexibele verbinder

Verbindt twee sporen in een willekeurige hoek met elkaar en maakt de verbinding tussen plafond- en muurmontage mogelijk.

Ensamblaje flexible

Ensamble dos rieles con cualquier ángulo entre si y permite la conexión entre el montaje en techo y paredes.

Connettore flessibile

Collega tra loro due binari con qualsiasi angolazione e consente il collegamento tra il montaggio a soffitto e a parete.

Conector Flex

Conectează două șine într-un unghi aleatoriu între ele și permite conectarea între sistemele de montaj pe plafon și pe perete.

Flex-liitin

Yhdistää kaksi kiskoa mihin tahansa kulmaan ja mahdollistaa yhteyden katto- ja seinäkiinnityksen välillä.

Łącznik elastyczny

Łączy dwie szyny pod dowolnym kątem i umożliwia połączenie między sufitem a ścianą.

7 Connecteur X

Relie quatre rails entre eux à angle droit.

X-verbinder

Verbindt vier sporen in een rechte hoek met elkaar.

Ensamblaje en X

Ensamble cuatro rieles en ángulo recto entre si.

Connettore a X

Collega insieme quattro binari ad angolo retto.

Conector X

Conectează patru șine în unghi drept între ele.

X-liitin

Yhdistää neljä kiskoa suorassa kulmassa toisiinsa nähden.

Łącznik X

Łączy cztery szyny pod kątem prostym.

8 Isolateur

Grâce à un isolateur, deux circuits séparés peuvent être reliés optiquement pour former un système.

Isolator

Door middel van de isolator kunnen twee aparte stroomkringen optisch verbonden worden tot één systeem.

Aislador

Por medio del aislador pueden conectarse dos circuitos de forma óptica a un sistema.

Isolatore

Utilizzando un isolatore, due circuiti separati possono essere collegati otticamente per formare un sistema.

Izolator

Prin intermediul izolatorului este posibilă conectarea optică a două circuite de comutare într-un sistem.

Eristin

Eristimen avulla kaksi erillistä piiriä voidaan kytkeä optisesti yhden järjestelmän muodostamiseksi.

Izolator

Za pomocą izolatora można optycznie połączyć dwa oddzielne obwody w celu utworzenia systemu.

9 Raccord en L

Relie deux rails entre eux à angle droit.

L-Connector

Verbindt twee sporen in een rechte hoek met elkaar.

Conector en L

Ensamble dos rieles en ángulo recto entre si.

Connettore a L

Collega insieme due binari ad angolo retto.

Conector în L

Conectează două piste pentru trasee în unghi drept unele cu altele.

L-Liitin

Yhdistää kaksi kiskoa toisiinsa suorassa kulmassa.

Złącze L

Łączy dwie szyny pod kątem prostym.

11 Raccord en T

Relie trois rails entre eux à angle droit.

T-Connector

Verbindt drie sporen in een rechte hoek met elkaar.

Conector en T

Ensamble tres rieles en ángulo recto entre si.

Connettore a T

Collega insieme tre binari ad angolo retto.

Conector în T

Conectează trei șine în unghi drept unele de altele.

T-Liitin

Yhdistää kolme kiskoa suorassa kulmassa toisiinsa.

Złącze T

Łączy trzy szyny pod kątem prostym.

15 Adaptateur pendulaire

Cet adaptateur pendulaire permet d'intégrer des luminaires suspendus conventionnels dans le système de rail DUOline.

Hangadapter

Deze hangadapter maakt het mogelijk gewone hanglampen in het DUOline-spoorsysteem te integreren.

Adaptador colgante

Este adaptador colgante le permite integrar las lámparas colgantes convencionales en el sistema de rieles de DUOline.

Adattatore per sospensione

Questo adattatore per sospensione consente l'integrazione di lampade a sospensione convenzionali nel sistema a binario DUOline.

Adaptor lustre

Acest adaptor pendular permite integrarea lustrelor uzuale în sistemul de piste DUOline.

Riippuväläissovitin

Tämä riippuväläissovitin mahdollistaa tavallisten riippuväläisimien integroinnin DUOline-kiskojärjestelmään.

Adapter zawieszania

Ten adapter do zawieszania umożliwia zintegrowanie tradycyjnych lamp wiszących z systemem szyn DUOline.

16 Raccourcisseur de câble

Permet de raccourcir les câbles des luminaires suspendus.

Snoerverkorter

Maakt het inkorten van het snoer van hanglampen mogelijk.

Acortador de cable

Es posible acortar el cable de las lámparas colgantes.

Sistema per accorciare il cavo

Permette di accorciare i cavi delle lampade a sospensione.

Prescurtare cablu

Permite scurtaarea cablurilor lustrelor.

Johdon lyhennin

Mahdollistaa riippuväläisimien johdon lyhentämisen.

Skracacz kabla

Pozwala skrócić kable lamp wiszących.

Seite Page	Artikel-Nr. Product No.	EAN-Nummer EAN-Number	Ersatzteile Spare parts	Seite Page	Artikel-Nr. Product No.	EAN-Nummer EAN-Number	Ersatzteile Spare parts
166	101000324	4017807504675	G1010-01	266	209500167	4017807488906	
166	101000524	4017807504682	G1010-01	527	212400201	4017807408799	
228	101600506	4017807430165		525	212400204	4017807490510	
228	101600806	4017807430172		525	212400207	4017807408850	
225	102000403	4017807387919		527	212400224	4017807408867	
225	102000405	4017807387926		527	212400232	4017807408812	
164	110300428	4017807369151		402	216070124	4017807212228	9797
230	110600331	4017807343656	92712-01	395	220810201	4017807258363	92335
230	110600378	4017807343663	92712-78	395	220810205	4017807258370	92335
230	110600531	4017807343670	92712-01	378	222270231	4017807387414	
230	110600578	4017807343687	92712-78	378	222270232	4017807387421	
170	110700328	4017807354140	92809	378	222370231	4017807387025	
170	110700528	4017807354164	92809	378	222370232	4017807387032	
227	112900531	4017807504941		381	222570207	4017807399899	
227	112900542	4017807509328		381	222570231	4017807399875	
227	112900931	4017807504934		381	222570232	4017807399882	
227	112900942	4017807509335		396	223210107	4017807386967	
406	200200131	4017807463002		396	223210131	4017807386974	
406	200200132	4017807463019		396	223210132	4017807386981	
406	200300131	4017807462975		396	223210231	4017807387001	
406	200300132	4017807462982		396	223210232	4017807387018	
412	200400100	4017807398694	92860	384	223310105	4017807371765	
407	200600131	4017807462791	S2006-01	384	223310131	4017807371772	
407	200600132	4017807462821	S2006-02	384	223310132	4017807371789	
171	200700128	4017807354188	92809	385	223410107	4017807303032	
403	200970124	4017807211832	92396	385	223410131	4017807303025	
408	201000101	4017807409642		385	223410132	4017807306309	
408	201100201	4017807409666		142	223510131	4017807421859	
132	201200100	4017807398632	92854	142	223510132	4017807421910	
228	201600206	4017807430158		142	223510231	4017807421965	
114	202000108	4017807436051	G2020-01	142	223510232	4017807421996	
114	202000132	4017807506372	G2020-01	250	223710130	4017807441871	
114	202000142	4017807432893	G2020-54	250	223790130	4017807441895	
415	202400106	4017807244908	92579	376	223810279	4017807299472	
130	202500101	4017807364927	92831-20	387	223910132	4017807451955	
270	203000230	4017807507041		387	223910167	4017807441147	
135	204400101	4017807364972	92830-22	377	224110179	4017807329018	
421	204700101	4017807276541	92717-13	346	224210102	4017807465914	
268	205570167	4017807442540		346	224290102	4017807465921	
268	205570267	4017807442564		254	224810131	4017807502749	
376	206400279	4017807364361		254	224810132	4017807502756	
376	206500279	4017807364378		254	224810167	4017807502763	
394	206600278	4017807364347		254	224819131	4017807502770	
294	207000188	4017807356076		254	224819132	4017807502787	
107	207500179	4017807382860		254	224819167	4017807502794	
107	207500189	4017807382877		386	224910231	4017807454413	
413	207700100	4017807385298	92915	386	224910232	4017807454437	
138	207800100	4017807189148	92259-20	388	225172924	4017807404517	
150	208070131	4017807407235		388	225172931	4017807404555	
150	208070132	4017807407242		388	225172942	4017807433401	
136	208700179	4017807385342	92920-79	388	225174724	4017807404586	
136	208700189	4017807385359	92920-89	388	225174731	4017807404593	
477	208870132	4017807388473		388	225174742	4017807433425	
84	209100107	4017807398564	S5091-01	398	225210104	4017807256314	
84	209100108	4017807398571	S5091-01	398	225210107	4017807256338	

Seite Page	Artikel-Nr. Product No.	EAN-Nummer EAN-Number	Ersatzteile Spare parts	Seite Page	Artikel-Nr. Product No.	EAN-Nummer EAN-Number	Ersatzteile Spare parts
390	225271007	4017807468823		392	274813005	4017807414790	
390	225271031	4017807468830		58	275510207	4017807455830	
390	225271507	4017807468878		61	275510231	4017807455816	
390	225271531	4017807468885		58	275510232	4017807455823	
390	225272007	4017807468908		336	279570931	4017807450460	
390	225272031	4017807468915		336	279570932	4017807450538	
393	225510207	4017807277913		399	279770104	4017807275346	
393	225610607	4017807277920		399	279770107	4017807275353	
397	225870107	4017807385489		399	279770108	4017807275360	
397	225870132	4017807385502		620	2803021-06	4017807147599	
383	229210207	4017807413304		620	2803031-06	4017807147605	9579
383	229210231	4017807413281		602	281570606	4017807245967	
383	229210232	4017807413298		602	281570906	4017807245950	
402	2502211-07	4017807103908	9413-01	592	282410106	4017807280821	
192	250810207	4017807464627		592	282410206	4017807280838	
192	250810231	4017807464634		606	282990106	4017807345070	
192	250810232	4017807464641		595	283110106	4017807382846	
420	2522011-06	4017807080797	92105	595	283110132	4017807508000	
420	2523011-01	4017807094756	9327-01	595	283110206	4017807382853	
192	253310105	4017807464443		595	283110232	4017807508024	
192	253310131	4017807464481		604	283270106	4017807384048	
192	253310132	4017807464528		604	283270132	4017807508116	
188	255410207	4017807415162		604	283270206	4017807384055	
188	255410231	4017807419726		604	283270232	4017807508123	
100	271170201	4017807247251	92765-01	604	283270306	4017807384062	
100	271170202	4017807247268	92765-02	604	283270332	4017807508154	
100	271170211	4017807508680		611	283400106	4017807508246	
100	271170214	4017807247282		611	283400132	4017807508253	
100	271370201	4017807358339		610	283500106	4017807513967	
100	271370211	4017807358346		610	283500132	4017807513998	
100	271370214	4017807358353		607	283600406	4017807514018	
379	271470207	4017807374681	92940-01	591	283770106	4017807508079	
379	271470279	4017807374698	92940-02	591	283770132	4017807508086	
88	271970601	4017807337280		591	283779106	4017807508093	
88	271970611	4017807337297		591	283779132	4017807508109	
427	272970401	4017807284652		600	283811206	4017807507997	
427	272970487	4017807284669		600	283811232	4017807507980	
427	272970701	4017807284676		600	283814206	4017807507959	
427	272970787	4017807284683		600	283814232	4017807507942	
429	273070401	4017807284690		600	283817906	4017807507966	
429	273070701	4017807284706		600	283817932	4017807507973	
429	273071301	4017807284713		596	283916006	4017807507904	
429	273071801	4017807284720		596	283916032	4017807507911	
426	273170301	4017807284737		596	283919006	4017807507928	
426	273170387	4017807284744		596	283919032	4017807507935	
426	273170401	4017807284751		598	284071206	4017807507638	
426	273170487	4017807284768		598	284071232	4017807507645	
425	273271201	4017807329087		598	284074206	4017807507676	
425	273271801	4017807329094		598	284074232	4017807507683	
428	273370307	4017807284799		598	284077906	4017807507652	
344	274510107	4017807381559		598	284077932	4017807507669	
392	274670105	4017807293968		608	284114006	4017807507591	
392	274670205	4017807293975		608	284114032	4017807507607	
472	274770107	4017807390049		608	284116006	4017807507614	
472	274770132	4017807390056		608	284116032	4017807507621	

Seite Page	Artikel-Nr. Product No.	EAN-Nummer EAN-Number	Ersatzteile Spare parts	Seite Page	Artikel-Nr. Product No.	EAN-Nummer EAN-Number	Ersatzteile Spare parts
161	300500104	4017807267112		290	304300132	4017807467499	
161	300500107	4017807262421		290	304300432	4017807467567	
161	300500109	4017807262438		290	304330332	4017807467512	
129	300600331	4017807467338	G30062-52	135	304400201	4017807364989	92830-040
129	300600342	4017807467345	G30062-54	303	304500104	4017807286151	92740
300	300700102	4017807298666		303	304500161	4017807286168	92740
300	300900101	4017807298673		303	304500162	4017807286175	92740
300	300900102	4017807298680		241	304800142	4017807277944	92720-42
284	301000167	4017807478143	G3010-52	301	305100161	4017807330533	
284	301000367	4017807478167	G3010-52	301	305100162	4017807330540	
280	301200101	4017807502626	S3012-01	126	305200179	4017807281064	92728-79
281	301200201	4017807502633	S3012-01	126	305200379	4017807287066	92727-79
132	301200300	4017807398649	92855	126	305290179	4017807287042	92727-79
234	301300142	4017807390322		287	305300488	4017807445237	
234	301300342	4017807390346		105	305400401	4017807336948	
234	301300442	4017807390353		105	305400411	4017807336955	
245	301400101	4017807195422	92270-01	105	305400441	4017807391022	
245	301400112	4017807195446	92270-12	105	305400479	4017807336962	
245	301400115	4017807195453	92270-15	105	305400489	4017807336979	
245	301400124	4017807195651	92270-24	269	305500467	4017807441093	
240	301600106	4017807343816	92876-06	238	305700179	4017807329148	
240	301690106	4017807349184	92810	222	305900126	4017807330816	
244	301700107	4017807196009	9408-01	222	305900130	4017807330809	
244	301700108	4017807196016	9408-01	125	306100132	4017807355789	92749-332
237	301800107	4017807262537	92700	125	306190132	4017807355819	92749-532
257	301900467	4017807502602		148	306200831	4017807477054	
115	302000308	4017807436112	G2020-01	148	306200832	4017807467864	
115	302000332	4017807506389	G2020-01	156	306700602	4017807373912	
115	302000342	4017807433067	G2020-54	156	306700632	4017807364392	
282	302100130	4017807451252	S30211-01	157	306700732	4017807399905	
282	302100430	4017807451269	S30212-01	294	307000188	4017807356090	
131	302500301	4017807364934		294	307000688	4017807356106	
276	302900102	4017807292497	92779	246	307290101	4017807343748	
274	303000132	4017807476781		236	307400331	4017807408010	
274	303000232	4017807468069		106	307500179	4017807382884	
274	303090132	4017807476798		120	307601006	4017807423198	G5076-54
163	303201532	4017807399509		118	307601206	4017807426861	G50761-54
97	303300101	4017807288292	92989-01	138	307800100	4017807189155	92258-30
97	303300102	4017807288308		138	307804100	4017807190083	92258-40
97	303300111	4017807508703	92989-11	154	307900432	4017807502701	
263	303400167	4017807425376		238	308000132	4017807288827	
262	303400367	4017807425383		285	308100567	4017807451221	
143	303500331	4017807422061		109	308200179	4017807392517	
143	303500332	4017807422078		82	308300307	4017807510638	92976-11
111	303600107	4017807454789	S3136-11	80	308300308	4017807510645	92976-01
111	303600132	4017807454772	S3136-44	236	308400206	4017807240191	
111	303600407	4017807454727	S3136-11	116	308500531	4017807468618	G40342-52
111	303600432	4017807454710	S3136-44	116	308500542	4017807468601	G40342-54
111	303690307	4017807451078	S3136-11	117	308590331	4017807468632	G40342-52
111	303690332	4017807451061	S3136-44	117	308590342	4017807468625	G40342-54
302	303700104	4017807286601		224	308600706	4017807378306	B3086-00
302	303700161	4017807286618		137	308700179	4017807385366	92925-79
302	303700162	4017807286625		137	308700189	4017807385373	92925-89
246	304100100	4017807247411		137	308700279	4017807385380	92924-79
246	304100106	4017807247404		137	308700289	4017807385397	92924-89

Seite Page	Artikel-Nr. Product No.	EAN-Nummer EAN-Number	Ersatzteile Spare parts	Seite Page	Artikel-Nr. Product No.	EAN-Nummer EAN-Number	Ersatzteile Spare parts
144	308900231	4017807425550		273	312300136	4017807504620	S3123-36
144	308900242	4017807425574		220	312400101	4017807408713	
144	308900331	4017807405224		220	312400107	4017807408737	
144	308900342	4017807425451		220	312400124	4017807408744	
144	308900631	4017807425581		220	312400132	4017807408720	
144	308900642	4017807425604		220	312400401	4017807408751	
288	309000167	4017807473421		220	312400407	4017807408775	
289	309000267	4017807466812		220	312400424	4017807408782	
288	309090167	4017807473414		220	312400432	4017807408768	
152	309200132	4017807473773		258	312700132	4017807502725	
152	309200432	4017807473803		258	312700432	4017807502718	
152	309230332	4017807473797		159	313300307	4017807503647	S3133-07
231	309300301	4017807354058	92836-04 92836-06 92836-07	159	313300308	4017807503678	S3133-08
231	309300302	4017807354102	92836-04 92836-06 92836-07	159	313300332	4017807503630	S3133-32
102	309400317	4017807423723		159	313300407	4017807503715	S3133-07
266	309500167	4017807488937		159	313300408	4017807503739	S3133-08
266	309500467	4017807488951		159	313300432	4017807503692	S3133-32
146	309800431	4017807387681		218	313400107	4017807504293	
146	309800432	4017807387698		218	313400131	4017807504255	
162	309900631	4017807330946		218	313400132	4017807504279	
162	309900632	4017807330953		218	313400407	4017807504354	
277	310100104	4017807408607		218	313400431	4017807504316	
278	310100106	4017807412536		218	313400432	4017807504330	
278	310100107	4017807395259		219	313400607	4017807504415	
278	310100108	4017807395266		219	313400631	4017807504378	
278	310100161	4017807356014		219	313400632	4017807504392	
278	310100162	4017807356021		271	313800332	4017807502855	
277	310100204	4017807408591		271	313800532	4017807502862	
278	310100561	4017807356038		140	313900132	4017807505061	S3139-32
278	310100562	4017807356045		140	313900232	4017807505085	S3139-32
112	310600101	4017807504453	G0106-31	127	315200109	4017807288001	92735-09
112	310600132	4017807427264	G0106-54	127	315200179	4017807287998	92735-79
112	310600154	4017807507478	G0106-54	127	315200189	4017807288018	92735-89
112	310600401	4017807504538	G0106-31	48	320310307	4017807487909	
112	310600432	4017807427288	G0106-54	48	320310308	4017807487916	
112	310600454	4017807507515	G0106-54	48	320310331	4017807487930	
112	310630301	4017807504491	G0106-31	48	320310332	4017807487923	
112	310630332	4017807435696	G0106-54	88	320910101	4017807330823	
112	310630354	4017807507492	G0106-54	88	320910111	4017807337181	
260	310700432	4017807502848		46	321210107	4017807454000	
260	310730332	4017807502831		46	321210108	4017807461145	
232	310800108	4017807503845		216	321611131	4017807468724	
232	310800308	4017807503852		216	321611132	4017807468731	
232	310890108	4017807503838	S31082-08	216	321691131	4017807468748	
276	310900111	4017807349160		216	321691132	4017807468755	
123	311210506	4017807367768	92829-40 92833-12 92833-14	37	321710107	4017807430486	
122	311210606	4017807367775	92829-50 92833-12 92833-14 92833-16	37	321710142	4017807430493	
				202	321910207	4017807453560	
				202	321910242	4017807453577	
				202	321910307	4017807453584	
				202	321910342	4017807453607	
				71	322610231	4017807424317	
				71	322610232	4017807424324	
				70	322610431	4017807424294	
				70	322610432	4017807424300	

Seite Page	Artikel-Nr. Product No.	EAN-Nummer EAN-Number	Ersatzteile Spare parts	Seite Page	Artikel-Nr. Product No.	EAN-Nummer EAN-Number	Ersatzteile Spare parts
68	322610489	4017807497809		540	371010408	4017807281798	92734-01
57	323210442	4017807460179		38	371310105	4017807445336	
201	323610307	4017807506365		38	371310131	4017807451801	
201	323610331	4017807506341		38	371310142	4017807445343	
201	323610332	4017807506358		539	371510407	4017807285017	92739
250	323710130	4017807451191		62	371610307	4017807391275	
64	324610131	4017807472912		62	371610331	4017807391282	
64	324610132	4017807470932		62	371690307	4017807391251	
64	324610179	4017807470949		62	371690331	4017807391268	
543	324810407	4017807257649	98249	214	371710142	4017807456608	
			98248	214	371710187	4017807456615	
543	324810428	4017807257854	98249	52	372610331	4017807377460	
			98248	67	372910106	4017807299267	
40	325010105	4017807422627		242	3751031-07	4017807137729	9350
40	325010132	4017807422634		242	3751041-07	4017807137736	9350
204	325110131	4017807467758		242	3751051-07	4017807169027	9350
204	325110132	4017807467789		198	375310502	4017807504446	
204	325110179	4017807467796		198	375310505	4017807504439	
210	325510407	4017807367973	92833	198	375310507	4017807472226	
210	325510507	4017807367980	92833	198	375310508	4017807481839	
206	325610305	4017807388022		198	375310532	4017807472233	
43	325710207	4017807473186		59	375510407	4017807469844	
43	325710231	4017807468519		60	375510431	4017807469868	
43	325710242	4017807468557		59	375510432	4017807469882	
34	326210107	4017807505221		239	376410402	4017807280906	
34	326210131	4017807505207		213	377310307	4017807274622	92707
34	326210132	4017807505214		212	377690105	4017807296280	
78	326410130	4017807505412		86	378010307	4017807391152	92871
32	326510107	4017807510034					92963
32	326510108	4017807510041		86	378010308	4017807391169	92872
32	326510142	4017807510058					92964
32	326510207	4017807510065		86	378010407	4017807391176	92871
32	326510208	4017807510072					92963
32	326510242	4017807510089		86	378010408	4017807391183	92872
32	326510307	4017807510096					92964
32	326510308	4017807510102		208	379090505	4017807282245	
32	326510342	4017807510119		209	379190707	4017807362831	
77	326610207	4017807505467		209	379190732	4017807471229	
77	326610232	4017807505474		74	379890307	4017807372984	
50	326810131	4017807506525		95	393900317	4017807505504	S3939-01
50	326810132	4017807506518					S3939-02
207	327210305	4017807504200					S3939-11
207	327210332	4017807504194		95	393900517	4017807505511	S693920-11
73	329010107	4017807423396					S693925-02
73	329010132	4017807423402					S693930-02
243	3407011-07	4017807103724	9408-01				S693935-01
247	3490400-00	4017807062465					S693940-01
247	3491400-00	4017807081541		446	400200107	4017807368390	
181	352710307	4017807453775		446	400200108	4017807378320	
181	352710342	4017807473308		443	400400107	4017807423211	S4004-11
247	3590010-01	4017807062496		443	400400132	4017807423228	S4004-11
75	370910606	4017807330670		160	400500104	4017807268621	
540	371010307	4017807281750	92734-01	160	400500107	4017807268638	
540	371010308	4017807281767	92734-01	160	400500109	4017807268645	
540	371010407	4017807281781	92734-01	168	401000224	4017807504712	G4010-01

Seite Page	Artikel-Nr. Product No.	EAN-Nummer EAN-Number	Ersatzteile Spare parts	Seite Page	Artikel-Nr. Product No.	EAN-Nummer EAN-Number	Ersatzteile Spare parts
98	401100101	4017807276121	92782-01	145	408900342	4017807425499	
98	401100102	4017807276138	92782-02	288	409000167	4017807466843	
98	401100111	4017807505580	S4011-11	85	409100307	4017807389654	92865-07
281	401200101	4017807502640	S3012-01	85	409100308	4017807389661	92865-08
438	401600131	4017807489422	S4016-01	266	409500167	4017807488920	
438	401600132	4017807489439	S4016-02	123	411210406	4017807367836	92829-40
441	401700317	4017807502541	S4017-01				92833-12
			S4017-02				92833-14
			S4017-11	480	412400107	4017807488777	
256	401900367	4017807502619		480	412400108	4017807488760	
115	402000108	4017807436099	G4020-01	480	412400131	4017807488784	
115	402000132	4017807506426	G2020-01	480	412400132	4017807488791	
115	402000142	4017807433012	G4020-54	258	412700132	4017807502732	
533	402500378	4017807353822		159	413300107	4017807507416	S3133-07
261	402690167	4017807502688		159	413300108	4017807507393	S3133-08
274	403000132	4017807468076		159	413300132	4017807507409	S3133-32
264	403400167	4017807426854		140	413900132	4017807505092	S3139-32
456	403400317	4017807422986	G40341-13	437	4200011-06	4017807105650	913240
			G40342-19	479	420490107	4017807295337	9243-01
			G40343-54	479	420490132	4017807382525	9243-01
456	403400354	4017807422948	G40341-54	471	420810107	4017807367614	
			G40342-54	470	420910107	4017807367591	
			G40343-54	470	420910108	4017807367607	
262	403490167	4017807430226		442	421100301	4017807194494	92287S-01
478	4035011-04	4017807090604	92174	442	421100302	4017807194500	92287S-02
478	4035011-07	4017807090611	92174	47	421210107	4017807454024	
478	4035011-08	4017807090628	92174	47	421210108	4017807461169	
99	403900201	4017807433654	S40391-01	36	421710107	4017807434323	
			S40392-01	36	421710142	4017807434316	
99	403900208	4017807494556	S40391-81	465	421910207	4017807267532	92685
			S40392-81				92685-01
99	403900211	4017807433661	S40391-11	465	421910228	4017807267549	92685
			S40392-11				92685-01
297	404200188	4017807354874		474	422410107	4017807358599	
290	404300332	4017807467727		474	422410108	4017807358605	
269	405500367	4017807466751		71	422610531	4017807423822	
148	406200532	4017807467901		71	422610532	4017807423853	
156	406700602	4017807373929		68	422610589	4017807497847	
156	406700632	4017807364415		463	422710307	4017807343076	
453	407400179	4017807357882	92822S	463	422710308	4017807354270	
106	407500179	4017807382921		451	422970206	4017807368260	92946
118	407690906	4017807423150	G5076-54				92821
272	407700114	4017807298758		57	423210542	4017807460155	
454	407800132	4017807303216		468	423310107	4017807505825	
154	407900332	4017807502695		468	423310108	4017807506105	
151	408000131	4017807407297		468	423310132	4017807506099	
151	408000132	4017807407303		44	423410107	4017807506297	
108	408200179	4017807392593		44	423410131	4017807506310	
109	408290179	4017807392616		44	423410132	4017807506327	
82	408300307	4017807510676	92976-11	459	423510101	4017807345032	
80	408300308	4017807510683	92976-01	461	424210304	4017807467635	
117	408500531	4017807468663	G40342-52	461	424210307	4017807467628	
117	408500542	4017807468670	G40342-54	461	424210308	4017807478259	
477	408800332	4017807390148		461	424210332	4017807467598	
145	408900331	4017807420838		64	424610131	4017807472899	

Seite Page	Artikel-Nr. Product No.	EAN-Nummer EAN-Number	Ersatzteile Spare parts	Seite Page	Artikel-Nr. Product No.	EAN-Nummer EAN-Number	Ersatzteile Spare parts
64	424610132	4017807470833		466	478310206	4017807336795	
64	424610179	4017807470901		466	478310506	4017807336801	
542	424810107	4017807257687	98249	74	479890307	4017807372953	
			98248	446	500200107	4017807368406	92819
542	424810128	4017807257861	98249	446	500200108	4017807378313	92819
			98248	160	500500104	4017807268669	
543	424810207	4017807257700	98249	160	500500107	4017807268676	
			98248	160	500500109	4017807268683	
543	424810228	4017807257878	98249	171	500700128	4017807354201	92809
			98248	168	501000224	4017807504729	G5010-01
458	424910207	4017807353938		101	501100101	4017807246810	
35	426219107	4017807505276		101	501100102	4017807246827	
35	426219131	4017807505252		101	501100111	4017807505535	S5011-11
35	426219132	4017807505269		280	501200101	4017807502657	S5012-01
78	426410130	4017807505450		114	502000108	4017807436075	G2020-01
464	426410207	4017807244717		114	502000132	4017807506402	G2020-01
464	426410208	4017807244724		114	502000142	4017807432992	G2020-54
432	426511807	4017807473407		282	502100130	4017807473476	S30212-01
432	426511831	4017807467376		492	5027011-01	4017807017366	
432	426511832	4017807467390		492	5027011-17	4017807051360	
50	426810131	4017807506495		492	5027011-47	4017807124941	
50	426810132	4017807506501		492	5028010-01	4017807051414	
434	427511801	4017807274332		492	5028010-02	4017807051421	
434	427511802	4017807274349		492	5028010-17	4017807051438	
434	427511887	4017807279511		492	5028010-47	4017807051445	
54	427710505	4017807451672		493	5029010-01	4017807051377	
54	427710532	4017807442205		493	5029010-47	4017807051407	
516	427890331	4017807383874	S8278-01	293	504300132	4017807467703	
516	427890332	4017807383881	S8278-01	124	506100132	4017807355833	92749-332
467	428210206	4017807256390		124	506190132	4017807355857	92749-532
72	429010107	4017807423433		106	507500179	4017807382945	
72	429010132	4017807423440		118	507690606	4017807423112	G5076-54
464	429110104	4017807267518	92694	272	507700114	4017807298727	
464	429110107	4017807267525	92694	454	507800132	4017807329179	
436	429910107	4017807273984		151	508000131	4017807407273	
191	451850101	4017807407464		151	508000132	4017807407280	
168	4602021-24	4017807196801	92274	108	508200179	4017807392555	
			92274-01	489	508300131	4017807422313	
98	461100101	4017807247220	92597-01	489	508300132	4017807422337	
98	461100102	4017807247237	92597-02	296	508400132	4017807387438	G5040-02
98	461100111	4017807508673		296	508400161	4017807387445	G5040-02
440	462100132	4017807398922	S4621-02	296	508400162	4017807387452	
452	467400102	4017807358988	92808	145	508900231	4017807425512	
75	470910406	4017807330632		145	508900242	4017807425536	
52	472610531	4017807387643		84	509100107	4017807398540	S5091-01
66	472910106	4017807299281		84	509100108	4017807398557	S5091-01
476	473190307	4017807302691		153	509200132	4017807473759	
476	473190331	4017807302707		112	510600101	4017807504552	G0106-31
476	473190332	4017807382532		112	510600132	4017807427240	G0106-54
455	474410179	4017807359633		112	510600154	4017807507522	G0106-54
472	474790107	4017807390087		101	511100101	4017807246841	92807-01
472	474790132	4017807390094		101	511100102	4017807246858	92807-02
450	475310307	4017807380439		101	511100111	4017807508710	
450	475310379	4017807380446		122	511210306	4017807367829	92829-28
448	475410207	4017807398595	S4754-01				92833-12

Seite Page	Artikel-Nr. Product No.	EAN-Nummer EAN-Number	Ersatzteile Spare parts	Seite Page	Artikel-Nr. Product No.	EAN-Nummer EAN-Number	Ersatzteile Spare parts
480	512400107	4017807488746		500	529690100	4017807262032	92671-00
480	512400108	4017807488753		500	529690107	4017807262070	92671-07
480	512400131	4017807488722		494	529990103	4017807248340	92584
480	512400132	4017807488739		494	529990107	4017807248364	92584
470	520910107	4017807367577		194	551753001	4017807407440	
470	520910108	4017807367584		194	551754001	4017807407457	
47	521210107	4017807454017		474	572410107	4017807337006	
47	521210108	4017807461152		474	572410108	4017807345162	
486	522520102	4017807226775		66	572910106	4017807303162	
486	522520187	4017807226782		515	573190107	4017807302677	
70	522610331	4017807423792		515	573190131	4017807302684	
70	522610332	4017807423815		488	573910101	4017807275636	92839
68	522610389	4017807497823		488	573910106	4017807275650	92839
483	523090131	4017807502503		502	574090107	4017807268973	92679-01
483	523090132	4017807502527		455	574410179	4017807359626	
56	523210242	4017807460117		450	575310307	4017807380453	
468	523310107	4017807505771		450	575310379	4017807380460	
468	523310108	4017807505818		448	575410207	4017807398588	S5754-01
468	523310132	4017807505801		86	578090107	4017807391190	92871
542	524810107	4017807257663	98249				92963
			98248	86	578090108	4017807391206	92872
542	524810128	4017807257885	98249				92964
			98248	495	579790104	4017807275285	
485	525410132	4017807457124		495	579790107	4017807275322	
485	525410187	4017807457148		495	579790108	4017807275339	
496	525490106	4017807371710	92826	74	579890307	4017807372960	
496	525490107	4017807371727	92826	501	5900011-07	4017807108033	
482	525690101	4017807372342		501	5900011-32	4017807506952	
496	525790107	4017807385663	92876	501	5901011-07	4017807108057	9426
496	525790108	4017807385670	92876	501	5901011-32	4017807506938	9426
496	525790132	4017807385687	92876-32	500	5908011-07	4017807135749	9262-01
32	526510107	4017807510140		500	5908011-32	4017807506976	9262-01
32	526510108	4017807510157		505	5914011-01	4017807150445	92281-01
32	526510142	4017807510164		505	5914011-02	4017807150452	92281
50	526810131	4017807506488		505	5914011-42	4017807150476	92281-42
50	526810132	4017807506471		502	592000107	4017807166705	9704
488	527090111	4017807372328		498	5922011-07	4017807081770	9309
488	527090131	4017807372335		498	5925011-07	4017807094985	9321
491	527290101	4017807291438		498	5925011-08	4017807094992	9321
491	527290102	4017807291445		159	593300107	4017807507379	S3133-07
486	527410101	4017807291452		159	593300108	4017807507386	S3133-08
486	527410142	4017807291513		159	593300132	4017807507362	S3133-32
497	527590107	4017807371758	92825	503	593900100	4017807224603	92496
497	527590132	4017807480313	92825	104	595400101	4017807337778	
497	527590179	4017807373103	92825	104	595400111	4017807337785	
487	527690131	4017807372304		104	595400141	4017807391046	
487	527690132	4017807372311		104	595400179	4017807337792	
54	527710305	4017807451665		104	595400189	4017807337808	
54	527710332	4017807442229		494	595500106	4017807154528	9610-01
484	527920101	4017807276046		494	595500107	4017807154535	9610-00
484	527920102	4017807276053		494	595500108	4017807156454	9610-00
467	528210106	4017807256413		499	599000106	4017807195958	92271-06
490	528310107	4017807244564		499	599000107	4017807195965	92271-07
490	528380107	4017807245899		499	599000108	4017807195972	92271-07
503	529310107	4017807262018	92672-07	499	599000118	4017807195989	92271-18

Seite Page	Artikel-Nr. Product No.	EAN-Nummer EAN-Number	Ersatzteile Spare parts	Seite Page	Artikel-Nr. Product No.	EAN-Nummer EAN-Number	Ersatzteile Spare parts
499	599000124	4017807195996	92271-07	104	605400541	4017807391039	
504	599600101	4017807256055	92934-01	104	605400579	4017807349238	
504	599600102	4017807257472	92934-02	104	605400589	4017807349245	
504	599600115	4017807256086		268	605500467	4017807442588	
504	599600119	4017807257793		417	605600307	4017807236996	92529
504	599600142	4017807256093		417	605600507	4017807237009	92529
412	600400100	4017807398656	92856	124	606100232	4017807394511	92755-432
412	600400200	4017807398663	92857	124	606100332	4017807394535	92755-532
129	600600331	4017807467352	G30062-52	394	606600178	4017807364354	
129	600600342	4017807467369	G30062-54	156	606700632	4017807373448	
170	600700328	4017807354225	92809	298	606900132	4017807504170	
166	601000324	4017807504699	G1010-01	298	606900161	4017807351781	
132	601200100	4017807398601	92851	298	606900162	4017807356823	
280	601200101	4017807502664	S3012-01	298	606903032	4017807512069	
132	601200200	4017807398618	92852	298	606903062	4017807517644	
419	601400106	4017807224580	92460	298	606905032	4017807512038	
256	601900467	4017807502596		298	606905062	4017807517668	
414	602100100	4017807223569	92465	120	607601006	4017807423174	G5076-54
282	602100130	4017807491500	S30211-01	120	607601206	4017807426885	G50761-54
414	602100200	4017807223576	92465-02	413	607700100	4017807385311	92916
404	602300301	4017807399578	S60232-01	413	607700200	4017807385328	92917
404	602300345	4017807399585	S60232-45	138	607800100	4017807189216	92259-30
404	602300394	4017807399592	S60232-94	150	608000331	4017807412598	
415	602400106	4017807244915	92579-25	150	608000332	4017807412604	
415	602400206	4017807244922	92579-30	400	608100224	4017807211795	92472-01
130	602500101	4017807364941	92831-30	400	608100324	4017807211788	92472
130	602500201	4017807364958	92831-40	108	608200279	4017807392531	
163	603201032	4017807399523		82	608300307	4017807510652	92978-11
409	603300101	4017807433784		80	608300308	4017807510669	92978-01
409	603390101	4017807433807		136	608700179	4017807385427	92921-79
142	603500331	4017807422047		136	608700189	4017807385434	92921-89
142	603500332	4017807422054		136	608700279	4017807385441	92922-79
405	603800287	4017807294088		136	608700289	4017807385458	92922-89
405	603800487	4017807294118		144	608900331	4017807413717	
96	603900201	4017807289688	92631-30	144	608900342	4017807425475	
96	603900202	4017807289695	92631-30	102	609400317	4017807423730	
96	603900211	4017807505603	S60391-11	146	609800431	4017807387704	
96	603900214	4017807289701	92631-30	146	609800432	4017807387711	
96	603900301	4017807256536	92662	162	609900331	4017807330960	
96	603900302	4017807256543	92662-02	162	609900332	4017807330984	
96	603900311	4017807505627	S60392-11	418	6101011-01	4017807017557	9218-01
96	603900314	4017807256550	92662-14	418	6101011-07	4017807028393	9218-01
96	603900501	4017807369298		168	6102021-24	4017807053296	92126
96	603900502	4017807369304		164	610300428	4017807369175	
96	603900511	4017807505634	S60393-11	416	6105011-01	4017807053968	9285-01
96	603900514	4017807369311		416	6105021-01	4017807098440	9287-01
134	604400101	4017807364996	92830-30	416	6107011-07	4017807028041	9231
134	604400201	4017807365009	92830-40	416	6107021-07	4017807080704	92151
134	604400301	4017807365016	92830-50	122	611210506	4017807367782	92829-40
364	604900331	4017807454284					92833-12
364	604900332	4017807454307					92833-14
364	604900631	4017807454345		273	612300236	4017807504637	S6123-36
364	604900632	4017807454369		526	612400501	4017807411614	
104	605400501	4017807349214		525	612400504	4017807490619	
104	605400511	4017807349221		525	612400507	4017807411638	

Seite Page	Artikel-Nr. Product No.	EAN-Nummer EAN-Number	Ersatzteile Spare parts	Seite Page	Artikel-Nr. Product No.	EAN-Nummer EAN-Number	Ersatzteile Spare parts
526	612400524	4017807411645		68	622610489	4017807497786	
526	612400532	4017807411621		70	622610531	4017807488821	
366	612900131	4017807426441		70	622610532	4017807488838	
366	612900132	4017807426465		68	622610589	4017807497861	
366	612900231	4017807426526		401	622811528	4017807262407	92686
366	612900232	4017807426533		56	623210242	4017807460070	
366	612900431	4017807426588		56	623210442	4017807460032	
366	612900432	4017807426595		44	623410207	4017807506235	
367	613000131	4017807426908		44	623410231	4017807506242	
367	613000132	4017807426915		44	623410232	4017807506259	
367	613000231	4017807426922		44	623419207	4017807506266	
367	613000232	4017807426939		44	623419231	4017807506273	
367	613000431	4017807426977		44	623419232	4017807506280	
367	613000432	4017807426984		250	623710130	4017807451184	
419	6160011-00	4017807131895	9516	338	623810431	4017807399806	
418	6196011-01	4017807138238	9523-01	377	624110279	4017807337051	92795
418	6196011-07	4017807138245	9523-07	324	624410306	4017807353952	
309	620010407	4017807449525		64	624610131	4017807472905	
309	620010431	4017807452204		64	624610132	4017807470918	
309	620010442	4017807449495		64	624610179	4017807470925	
325	620210206	4017807392449		542	624830307	4017807257724	98249
48	620310307	4017807487862					98248
48	620310308	4017807487893		542	624830328	4017807257892	98249
48	620310331	4017807487879					98248
48	620310332	4017807487886		40	625010105	4017807422641	
311	620510307	4017807488586		40	625010132	4017807422658	
311	620510331	4017807488579		42	625710207	4017807473223	
311	620510332	4017807488562		42	625710231	4017807473230	
46	621210107	4017807453980		42	625710242	4017807473247	
46	621210108	4017807461121		345	625815031	4017807506457	
46	621290107	4017807453997		34	626210107	4017807505191	
46	621290108	4017807461138		34	626210131	4017807505177	
513	621410505	4017807220940	92426	34	626210132	4017807505184	
36	621710107	4017807430509		79	626410530	4017807505429	
36	621710142	4017807430516		372	626510987	4017807245202	
90	621910301	4017807503975	S6219-01	372	626511287	4017807245226	
90	621910302	4017807503999	S6219-02	372	626512587	4017807246803	
90	621910317	4017807504019	S6219-01	76	626610207	4017807505481	
			S6219-02	76	626610232	4017807505498	
			S6219-11	331	626710531	4017807505719	
91	621910501	4017807504026	S6219-01	331	626710532	4017807505726	
91	621910502	4017807504033	S6219-02	331	626710587	4017807505733	
91	621910517	4017807504064	S6219-01	349	626910307	4017807506587	
			S6219-02	349	626910332	4017807506594	
			S6219-11	349	626919307	4017807506600	
93	621911201	4017807337105		349	626919332	4017807506617	
93	621911211	4017807337112		361	627514000	4017807401837	
93	621912401	4017807337143		361	627516000	4017807401820	
93	621912411	4017807337150		54	627710405	4017807451702	
92	621914001	4017807384468		54	627710432	4017807442182	
92	621914011	4017807384475		54	627710505	4017807451658	
92	621915501	4017807384482		54	627710532	4017807448184	
92	621915511	4017807384499		319	628410507	4017807504071	
70	622610431	4017807424270		319	628410532	4017807504040	
70	622610432	4017807424287		362	628513001	4017807298819	

Seite Page	Artikel-Nr. Product No.	EAN-Nummer EAN-Number	Ersatzteile Spare parts	Seite Page	Artikel-Nr. Product No.	EAN-Nummer EAN-Number	Ersatzteile Spare parts
362	628613001	4017807298826		574	650710107	4017807376944	
358	628915001	4017807272307		574	650710131	4017807376951	
358	629010101	4017807381511		574	650710132	4017807442601	
72	629010107	4017807423426		574	650710306	4017807376975	
72	629010132	4017807423419		574	650710307	4017807376968	
584	650000106	4017807376210		574	650710331	4017807376982	
584	650000107	4017807376234		182	651110207	4017807425291	
584	650000108	4017807376241		182	651110232	4017807425314	
584	650000131	4017807376203		189	651210507	4017807389753	
584	650000132	4017807378061		586	651500131	4017807455915	
584	650000306	4017807376258		586	651500132	4017807455939	
584	650000307	4017807376265		586	651600131	4017807455946	
584	650000331	4017807376272		586	651600132	4017807455977	
584	650100106	4017807376302		586	651600231	4017807456011	
584	650100107	4017807376319		586	651600232	4017807455991	
584	650100108	4017807376326		587	651600331	4017807456035	
584	650100131	4017807376296		587	651600332	4017807456059	
584	650100132	4017807378078		582	651700152	4017807425888	
584	650100306	4017807376333		582	651800152	4017807425901	
584	650100307	4017807376340		193	651914001	4017807389609	
584	650100331	4017807376357		193	651915501	4017807389616	
576	650210106	4017807376388		582	652100152	4017807425925	
576	650210107	4017807376395		582	652200152	4017807425949	
576	650210131	4017807376371		580	652310106	4017807427660	
576	650210306	4017807376418		580	652310131	4017807427677	
576	650210307	4017807376425		580	652310132	4017807504095	
576	650210331	4017807376432		580	652410106	4017807427684	
576	650310106	4017807376463		580	652410131	4017807427691	
576	650310107	4017807376470		580	652410132	4017807504101	
576	650310131	4017807376456		578	652510106	4017807427707	
576	650310306	4017807376494		578	652510131	4017807427714	
576	650310307	4017807376500		578	652510132	4017807504132	
576	650310331	4017807376517		578	652610106	4017807427721	
572	650410106	4017807376630		578	652610131	4017807427738	
572	650410107	4017807376647		578	652610132	4017807504156	
572	650410131	4017807376623		183	652610307	4017807453881	
572	650410132	4017807378030		183	652610342	4017807453751	
572	650410306	4017807376661		183	652690307	4017807453898	
572	650410307	4017807376678		183	652690342	4017807453768	
572	650410331	4017807376685		180	652710307	4017807453799	
572	650510106	4017807376753		180	652710342	4017807473339	
572	650510107	4017807376760		184	652810331	4017807469189	
572	650510131	4017807376722		184	652810332	4017807469196	
572	650510132	4017807378085		184	652810531	4017807472929	
572	650510306	4017807376838		184	652810532	4017807472936	
572	650510307	4017807376845		508	652910131	4017807473643	
572	650510331	4017807376852		508	652910132	4017807473650	
574	650610106	4017807376869		508	652910231	4017807473667	
574	650610107	4017807376876		508	652910232	4017807473674	
574	650610131	4017807376890		508	652910331	4017807473681	
574	650610132	4017807442595		508	652910332	4017807473698	
574	650610306	4017807376906		190	656010100	4017807389845	
574	650610307	4017807376913		190	656010101	4017807389838	
574	650610331	4017807376920		190	656090100	4017807389869	
574	650710106	4017807376937		411	656211800	4017807372007	92834-40

Seite Page	Artikel-Nr. Product No.	EAN-Nummer EAN-Number	Ersatzteile Spare parts	Seite Page	Artikel-Nr. Product No.	EAN-Nummer EAN-Number	Ersatzteile Spare parts
373	656411506	4017807371796		308	672610332	4017807441208	
373	656412406	4017807371802		347	672810202	4017807503166	
373	656511806	4017807371826		347	672819202	4017807503173	
373	656512006	4017807371833		66	672910106	4017807299274	
375	657010601	4017807294637		410	673012489	4017807337464	92811-40
375	657010607	4017807294675		334	673210306	4017807388411	
375	657011201	4017807294712		334	673210331	4017807388428	
375	657011207	4017807294729		334	673210332	4017807441192	
375	657011801	4017807294743		339	673311306	4017807358407	
375	657011807	4017807294750		410	673611201	4017807342277	92792
374	657110601	4017807294651		332	673810206	4017807433333	
374	657110607	4017807294668		332	673810232	4017807433364	
374	657111201	4017807294705		333	673810306	4017807505689	
374	657111207	4017807294699		333	673810332	4017807505702	
374	657111801	4017807294767		332	673890206	4017807433371	
374	657111807	4017807294774		332	673890232	4017807433388	
187	657411107	4017807436358		326	673916007	4017807452594	
186	657413007	4017807436341		326	673916031	4017807452235	
187	657414007	4017807434521		326	673916032	4017807441437	
187	657416007	4017807434552		326	673918007	4017807452617	
186	657493007	4017807436334		326	673918031	4017807452259	
186	657494007	4017807434415		326	673918032	4017807441468	
186	657496007	4017807434439		371	674011207	4017807363708	
360	657810100	4017807351064		370	674013007	4017807363630	
594	659011801	4017807280081		371	674014507	4017807363654	
594	659011806	4017807508413		371	674016207	4017807363692	
594	659011832	4017807508406		370	674093007	4017807363623	
594	659011887	4017807280098		370	674094507	4017807363647	
616	659411806	4017807280050		370	674096207	4017807363685	
616	659412406	4017807280074		312	674410307	4017807455854	
321	670710507	4017807503470		312	674410331	4017807477108	
321	670710532	4017807503456		312	674410342	4017807455847	
322	670810607	4017807503531		344	674510107	4017807381566	
322	670810632	4017807503524		316	674610507	4017807385786	
350	671210131	4017807489835		316	674610707	4017807450224	
350	671210132	4017807489842		58	675510507	4017807455779	
351	671290131	4017807489859		61	675510531	4017807455755	
351	671290132	4017807489866		58	675510532	4017807455762	
38	671310105	4017807445329		357	675610106	4017807363302	
38	671310131	4017807451832		314	676210307	4017807371918	
38	671310142	4017807445312		314	676210342	4017807425703	
539	671510507	4017807285000	92739	314	676210407	4017807425734	
62	671610307	4017807391237		314	676210442	4017807425758	
62	671610331	4017807391244		315	676290307	4017807371925	
343	671710442	4017807466959		340	676611031	4017807398533	
343	671710479	4017807466935		340	676615031	4017807398519	
342	671710742	4017807466867		340	676617531	4017807398526	
342	671710779	4017807466881		356	677610106	4017807355345	92842
307	672110505	4017807503982		356	677690106	4017807355352	
307	672110542	4017807503951		359	677718000	4017807337686	92804
307	672110542	4017807503951		363	678513001	4017807431070	
328	672310207	4017807503371		363	678613001	4017807431087	
328	672310231	4017807503333		355	678710006	4017807337730	92864
328	672310232	4017807503357		354	678711206	4017807337716	
52	672610331	4017807377477		355	678713006	4017807337723	

Seite Page	Artikel-Nr. Product No.	EAN-Nummer EAN-Number	Ersatzteile Spare parts	Seite Page	Artikel-Nr. Product No.	EAN-Nummer EAN-Number	Ersatzteile Spare parts
368	679010031	4017807476422		553	701232	4017807470369	
368	679015031	4017807476415		553	701287	4017807470376	
368	679095031	4017807476408		555	702031	4017807470383	
353	679110032	4017807471069		555	702032	4017807470390	
352	679112132	4017807471021		555	702087	4017807470406	
353	679114232	4017807471045		555	702131	4017807470475	
360	679210106	4017807440348		555	702132	4017807470482	
337	679511531	4017807450712		555	702187	4017807470499	
337	679511532	4017807450767		557	702231	4017807470505	
621	6801011-01	4017807259056		557	702232	4017807470543	
621	6801011-06	4017807147575	9580	557	702231A	4017807474855	
621	6801011-07	4017807147582	9580	557	702232A	4017807474862	
621	6801011-32	4017807507690		557	702287	4017807470550	
615	680213500	4017807508475		557	702287A	4017807474879	
615	680214800	4017807508482		557	702331	4017807470567	
617	680310106	4017807508437		557	702332	4017807470574	
617	680310132	4017807508444		557	702331A	4017807482171	
617	680319106	4017807508451		557	702332A	4017807482188	
617	680319132	4017807508468		557	702387	4017807470581	
618	680710106	4017807507843		557	702387A	4017807482195	
618	680710131	4017807507867		555	702431	4017807470598	
618	680710132	4017807507881		555	702432	4017807470604	
590	680810306	4017807508505		555	702487	4017807470611	
590	680810332	4017807508512		555	702531	4017807470628	
590	680819306	4017807508529		555	702532	4017807470635	
590	680819332	4017807508536		555	702587	4017807470642	
592	682410506	4017807280845		558	703031	4017807471397	
614	686014000	4017807507744	E6260-00	558	703032	4017807471403	
614	686014001	4017807507720	E6260-00	558	703087	4017807471410	
593	686412406	4017807507805		558	703131	4017807471427	
593	686512406	4017807507829		558	703132	4017807471434	
619	689214032	4017807507768		558	703187	4017807471441	
619	689314032	4017807507782		558	703231	4017807471458	
94	693900417	4017807409451	S693915-11	558	703232	4017807471465	
			S693920-02	558	703287	4017807471472	
			S693925-01	559	703331	4017807471489	
			S693930-01	559	703332	4017807471502	
94	693900517	4017807399547	S693920-11	559	703387	4017807471519	
			S693925-02	559	703431	4017807474886	
			S693930-02	559	703531	4017807474893	
			S693935-01	559	703532	4017807474909	
			S693940-01	559	703587	4017807474916	
552	700131	4017807470161		559	703952	4017807471533	
552	700132	4017807470178		563	73043107	4017807505955	
552	700187	4017807470246		563	73043131	4017807505931	
552	700231	4017807470277		563	73043132	4017807505948	
552	700232	4017807470307		568	73120102	4017807471557	
552	700287	4017807470253		562	73240107	4017807471564	
552	701031	4017807470321		562	73240131	4017807471571	
552	701032	4017807470338		562	73240132	4017807471588	
552	701087	4017807470345		568	73330101	4017807471595	
552	701131	4017807474824		568	73330111	4017807471618	92989-11
552	701132	4017807474831		564	73430132	4017807506037	
552	701187	4017807474848		564	73520101	4017807471656	
553	701231	4017807470352		568	73820180	4017807505856	

Seite Page	Artikel-Nr. Product No.	EAN-Nummer EAN-Number	Ersatzteile Spare parts	Seite Page	Artikel-Nr. Product No.	EAN-Nummer EAN-Number	Ersatzteile Spare parts
568	76390201	4017807472110		522	800700332	4017807469301	
568	76390211	4017807472127		522	800700407	4017807469325	
568	76820280	4017807505832		522	800700431	4017807469349	
566	76921031	4017807505962		522	800700432	4017807469363	
566	76921032	4017807505979		256	801900167	4017807502558	
566	76921087	4017807505986		256	801900267	4017807502565	
566	76921531	4017807505993		256	801900367	4017807502589	
566	76921532	4017807506006		526	802400101	4017807227543	
566	76921587	4017807506013		524	802400104	4017807490534	
520	770010587	4017807287196		524	802400107	4017807231335	
566	77020131	4017807472028		526	802400124	4017807408621	
566	77020132	4017807472035		526	802400132	4017807408614	
566	77020187	4017807472042		526	802400201	4017807227550	
518	775910506	4017807285994		524	802400204	4017807490558	
520	778210506	4017807281576		524	802400207	4017807231359	
518	779310707	4017807336900		526	802400224	4017807408645	
564	78010107	4017807471946		526	802400232	4017807408638	
564	78010131	4017807471922		526	802400301	4017807227567	
564	78010132	4017807471939		524	802400304	4017807490572	
560	78030131	4017807505900		524	802400307	4017807231373	
560	78030132	4017807505917		526	802400324	4017807408669	
560	78030187	4017807505924		526	802400332	4017807408652	
560	78070107	4017807472073		527	802430401	4017807227574	
560	78070131	4017807472080		524	802430404	4017807490596	
560	78070132	4017807472103		524	802430407	4017807231397	
560	78150107	4017807505894		527	802430424	4017807408683	
560	78150131	4017807505870		527	802430432	4017807408676	
560	78150132	4017807505887		532	802500178	4017807299519	
564	78170107	4017807471663		532	802500278	4017807299526	
562	78240107	4017807471694		532	802500378	4017807299540	
562	78240131	4017807471700		532	802530478	4017807353808	
562	78240132	4017807471724		536	803000107	4017807348262	
569	78330101	4017807471977		536	803000207	4017807348279	
569	78330111	4017807471991		536	803000307	4017807348286	
569	78330179	4017807472295		537	803000407	4017807348309	
564	78430132	4017807506020		537	803000607	4017807348293	
545	800300132	4017807351392		536	803080107	4017807348330	
545	800300232	4017807351415		537	803090307	4017807348323	
545	800300432	4017807351644		544	803100104	4017807353235	92812-01
529	800600131	4017807446265		544	803100204	4017807353259	92812-01
529	800600132	4017807451726		544	803100304	4017807353273	92812-01
528	800600231	4017807446272		544	803100404	4017807353297	92812-01
528	800600232	4017807451740		264	803400167	4017807430196	
528	800600431	4017807446296		264	803400267	4017807430202	
528	800600432	4017807451788		264	803400367	4017807430219	
528	800690331	4017807446289		530	803500131	4017807408201	S8035-02
528	800690332	4017807451764		530	803500132	4017807408225	S8035-02
522	800700107	4017807469103		530	803500231	4017807408232	S8035-02
522	800700131	4017807469127		530	803500232	4017807408249	S8035-02
522	800700132	4017807469141		530	803500331	4017807408256	S8035-02
522	800700207	4017807469165		530	803500332	4017807408263	S8035-02
522	800700231	4017807469202		530	803590431	4017807408294	S8035-02
522	800700232	4017807469226		530	803590432	4017807408300	S8035-02
522	800700307	4017807469264		110	803600207	4017807451016	S8036-11
522	800700331	4017807469288		110	803600232	4017807451009	S8036-44

Seite Page	Artikel-Nr. Product No.	EAN-Nummer EAN-Number	Ersatzteile Spare parts	Seite Page	Artikel-Nr. Product No.	EAN-Nummer EAN-Number	Ersatzteile Spare parts
110	803600307	4017807451047	S8036-11	517	827890232	4017807383799	S8278-01
110	803600332	4017807451030	S8036-44	516	827890331	4017807383812	S8278-01
110	803670107	4017807450989	S8036-11	516	827890332	4017807383829	S8278-01
110	803670132	4017807450972	S8036-44	510	828510331	4017807378221	
292	804300332	4017807467666		510	828510431	4017807378245	
292	804300432	4017807467680		510	828530531	4017807378283	
292	804370132	4017807467604		510	828570231	4017807378207	
292	804370232	4017807467642		540	871010107	4017807281637	92734
286	805300188	4017807445183		540	871010108	4017807281644	92734
286	805300288	4017807445190		540	871010207	4017807281651	92734
286	805300388	4017807445206		540	871010208	4017807281668	92734
286	805300488	4017807445213		540	871010307	4017807281675	92734
252	812400107	4017807487947		540	871010308	4017807281682	92734
252	812400131	4017807487961		540	871010407	4017807281712	92734
252	812400132	4017807487954		540	871010408	4017807281729	92734
252	812400207	4017807487978		541	871010607	4017807281736	92734
252	812400231	4017807487992		541	871010608	4017807281743	92734
252	812400232	4017807487985		541	871090307	4017807281699	92734
252	812400307	4017807488005		541	871090308	4017807281705	92734
252	812400331	4017807488029		538	871510207	4017807284904	92739
252	812400332	4017807488012		538	871510407	4017807284966	92739
252	812400407	4017807488036		539	871510607	4017807284980	92739
252	812400431	4017807488067		538	871570107	4017807284898	92739
252	812400432	4017807488043		538	871590307	4017807284942	92739
534	818000206	4017807203059		514	873110307	4017807302615	
534	818000306	4017807203066		514	873110331	4017807302622	
534	818070106	4017807203042		514	873110407	4017807302639	
512	821410305	4017807220902	92426	514	873110431	4017807302646	
512	821410405	4017807220919	92426	515	873110607	4017807302653	
512	821410605	4017807220933	92426	515	873110631	4017807302660	
513	821430405	4017807220926	92426	514	873170107	4017807302578	
513	821470105	4017807220889	92426	514	873170131	4017807302585	
512	821470205	4017807220896	92426	514	873170207	4017807302592	
542	824810107	4017807257526	98249	514	873170231	4017807302608	
			98248	612	880400106	4017807508031	
542	824810128	4017807257809	98249	612	880400132	4017807508048	
			98248	612	880400406	4017807508383	
542	824810207	4017807257540	98249	612	880400432	4017807508390	
			98248	612	880430306	4017807508369	
542	824810228	4017807257816	98249	612	880430332	4017807508376	
			98248	423	891010107	4017807358049	92734
542	824810307	4017807257564	98249	422	8911211-07	4017807118780	
			98248	423	891770107	4017807358162	92816
542	824810328	4017807257823	98249	422	899670107	4017807358155	
			98248	627	901-454	4017807412666	
542	824810407	4017807257588	98249	627	901-479	4017807351446	
			98248	627	902-454	4017807412680	
542	824810428	4017807257830	98249	627	902-479	4017807351453	
			98248	627	903-454	4017807412703	
517	827830431	4017807383843	S8278-01	627	903-479	4017807351460	
517	827830432	4017807383850	S8278-01	627	904-454	4017807412727	
516	827890131	4017807383751	S8278-01	627	904-479	4017807351477	
516	827890132	4017807383768	S8278-01	627	905-454	4017807412741	
517	827890231	4017807383782	S8278-01	627	905-479	4017807351484	
				630	929-220	4017807293319	

Seite Page	Artikel-Nr. Product No.	EAN-Nummer EAN-Number	Ersatzteile Spare parts	Seite Page	Artikel-Nr. Product No.	EAN-Nummer EAN-Number	Ersatzteile Spare parts
630	929-230	4017807355000		625	987-410	4017807394917	
630	929-2300	4017807394924		625	987-479	4017807509106	
284	92945	4017807478174		624	987-60	4017807279252	
631	955-50	4017807277074		626	987-600	4017807288056	
630	955-55	4017807277098		626	987-679	4017807288049	
631	956-30	4017807277050		625	987-6700	4017807387636	
631	956-330	4017807509151		624	987-6810	4017807358735	
631	956-355	4017807509144		624	987-7009	4017807508949	
631	956-509	4017807508987		624	987-909	4017807508956	
631	956-55	4017807300369		624	988-10	4017807300338	
631	956-5736	4017807380057		624	988-110	4017807394894	
631	956-5936	4017807380071		625	988-600	4017807287516	
629	983-200	4017807508840		626	988-654	4017807416220	
629	983-279	4017807508857		626	988-679	4017807287530	
630	983-3200	4017807508901		624	988-700	4017807394887	
630	983-3279	4017807508932		626	988-710	4017807433449	
628	983-40	4017807240566		629	989-200	4017807508864	
629	983-400	4017807302097		629	989-279	4017807508871	
629	983-410	4017807394900		629	989-3200	4017807508918	
628	983-43	4017807260540		629	989-3279	4017807508925	
630	983-4470	4017807358940		628	989-40	4017807240597	
630	983-4790	4017807509137		629	989-400	4017807287486	
628	983-509	4017807508963		628	989-43	4017807260557	
628	983-56	4017807394863		629	989-4470	4017807358926	
628	983-60	4017807279214		629	989-479	4017807287523	
628	983-63	4017807279221		629	989-4790	4017807509083	
628	983-66	4017807300345		629	989-4790	4017807509083	
625	985-6810	4017807358759		628	989-509	4017807508970	
624	986-40	4017807268782		628	989-56	4017807394870	
624	986-43	4017807268799		628	989-60	4017807279238	
624	986-60	4017807280647		628	989-63	4017807279245	
624	986-63	4017807280654		628	989-66	4017807300352	
626	986-6790	4017807509120		629	990-200	4017807508895	
626	986-6810	4017807358766		629	990-279	4017807508888	
626	986-710	4017807433463		628	990-40	4017807240610	
625	987-2400	4017807303933		629	990-400	4017807287493	
625	987-2479	4017807509113		629	990-4470	4017807358933	
624	987-260	4017807509090		629	990-4790	4017807509076	
624	987-400	4017807287509					

TRIO behält sich das Recht vor, zu jeder Zeit, notwendige Änderungen oder Aktualisierungen der in diesem Katalog enthaltenen Produkte vorzunehmen. · TRIO reserves the right to carry out any time, necessary changes or updates of the products in this catalogue. · TRIO se réserve le droit d'apporter à tout moment les modifications ou actualisations nécessaires aux produits dans ce catalogue. · TRIO behoudt zich het recht voor op ieder moment noodzakelijke wijzigingen of updates aan de producten in deze catalogus door te voeren. · TRIO se reserva , en todo momento, el derecho a realizar las modificaciones o actualizaciones que considere necesarias para cualquier producto de este catálogo. · TRIO si riserva il diritto di apportare, in qualunque momento, tutte le modifiche necessarie ai prodotti di questo catalogo. · TRIO-ul își rezervă dreptul de a face oricând orice modificări sau actualizări necesare pentru produsele din acest catalog. · TRIO pidättää oikeuden tehdä muutoksia tai päivittää tuotteita tässä luettelossa. · TRIO zastrzega sobie prawo do wprowadzania w dowolnym czasie zmian lub aktualizacji produktów zawartych w katalogu.

KONTAKTE

Contact · Contact · Contact · Contactar · Contatto · Contact · Yhteydenotto · Kontakt

TRIO Leuchten GmbH

Gut Nierhof 17
D-59757 Arnsberg

T +49 2931 9666-0
F +49 2931 9666-57

info@trio-leuchten.de
www.trio-leuchten.de

NIEDERSACHEN, SCHLESWIG-HOLSTEIN, HAMBURG, BREMEN

Jens Gebers

T +49 170 1615227
jens.gebers@trio-leuchten.de

BERLIN, BRANDENBURG, MECKL.-VORPOMMERN, SACHSEN, SACHSEN ANHALT, THÜRINGEN

Jörg Bumke

T +49 160 7406860
joerg.bumke@trio-leuchten.de

NORDRHEIN-WESTFALEN

Antonio Capizzi

T +49 172 2598392
capizziantonio@t-online.de

SAARLAND, RHEINLAND-PFALZ, HESSEN

Christian Teller

T +49 171 4521820
christian.teller@trio-leuchten.de

ÖSTERREICH

Wolfgang Melich

T +43 660 5161228
wolfgang.melich@trio-leuchten.de

BADEN WÜRTTEMBERG

Antonio De Simone

T +49 151 58555222
antonio.desimone@trio-leuchten.de

SCHWEIZ

Andreas Huber

T +41 (0) 76 316 22 89
andreas.huber@trio-leuchten.ch

BAYERN, HESSEN

Martin Kluge

T +49 171 7300330
martin.kluge@trio-leuchten.de

 @trioleuchten

 /trioleuchten

 @trio.lighting



TRIO International GmbH

Gut Nierhof 17
D-59757 Arnsberg

T +49 2931 9666-587
F +49 2931 9666-56

info@trio-lighting.com
www.trio-lighting.com

FRANCE

Stéphane Papierny

Directeur Commercial France
info.france@trio-lighting.com

Jean Philippe Bailly

info.france@trio-lighting.com
Agent exclusif pour les départements
60, 75001-75004, 75008-75010,
75017-75019, 92, 93, 95

Jean Barel

info.france@trio-lighting.com
Agent exclusif pour les départements
09, 12, 15, 16, 19, 23, 24, 31, 32, 33, 40,
46, 47, 64, 65, 81, 82 et 87

Elsa Seron

info.france@trio-lighting.com
Agent exclusif pour les départements
27, 28, 76

Antoine Masu

info.france@trio-lighting.com
Agent exclusif pour les départements
2a et 2b

Christophe Meulien

info.france@trio-lighting.com
Agent exclusif pour les départements
04, 05, 06, 11, 13, 30, 34, 66, 83 et 84

Stéphane Riebel

info.france@trio-lighting.com
Agent exclusif pour les départements
18, 45, 58, 75005-75007, 75011-75016,
75020, 77, 78, 89, 91, 94

Michel Salamand

info.france@trio-lighting.com
Agent exclusif pour les départements
14, 17, 22, 29, 35, 36, 37, 41, 44, 49, 50,
53, 56, 61, 72, 79, 85 et 86

Vincent Zaepffel

info.france@trio-lighting.com
Commercial pour les départements
02, 08, 10, 25, 51, 52, 54, 55, 57, 59, 62,
67, 68, 70, 80, 88 et 90

Sullivan Nicolas

info.france@trio-lighting.com
Agent exclusif pour les départements
01, 03, 07, 21, 26, 38, 39, 42, 43, 48, 63,
69, 71, 73 et 74

NEDERLAND

Karl Stok / Bas Martin

info.nederland@trio-lighting.com

BELGIUM/BELGIQUE

Yves van den Berghe

info.belgium@trio-lighting.com

ITALIA

TRIO Lighting Italia s.r.l

Via Padre Masciadri, 2 H
IT-22066 Mariano Comense (CO)
T +39 317 477 55
F +39 313 551 560
commerciale@trio-lighting.com

ESPAÑA

TRIO Lighting Ibèrica SL

C/ Can Lietget n°9 nave9
Pol. Ind. Can Roqueta
08206 Sabadell
T +34 9 35 45 86 30
F +34 9 33 96 45 48
info.iberica@trio-lighting.com

SUOMI

TRIO Lighting Scandinavia Oy

Malmin raitti, rappu 17 B
00700 Helsinki
T +358 10 23 13 390
F +358 10 23 13 399
info.scandinavia@trio-lighting.com
Our Scandinavian organisation represents TRIO
also in Sweden, Norway, Estonia, Latvia
and Lithuania

GREAT BRITAIN

TRIO Lighting UK Ltd.

Unit 5, Hemmells Park Hemmells, Laindon
Essex
SS1s 6GF
T +44 12 68 88 95 95
F +44 12 68 88 95 96
sales@trio-lightinguk.com

ROMANIA

Gina Ionita

info.romania@trio-lighting.com

NOTIZEN · NOTES

A series of horizontal dashed lines for writing notes.



TRIO Leuchten GmbH

Gut Nierhof 17
D-59757 Arnsberg

T +49 2931 9666-0
F +49 2931 9666-28

info@trio-leuchten.de
www.trio-leuchten.de

TRIO International GmbH

Gut Nierhof 17
D-59757 Arnsberg

T +49 2931 9666-587
F +49 2931 9666-56

info@trio-lighting.com
www.trio-lighting.com

 @trioleuchten

 /trioleuchten

 @trio.lighting

LIGHTING FOR YOU